

Pictorial index	Search by illustration
1 For safety and security	Make sure to read through them
2 Instrument cluster	How to read the gauges and meters, the variety of warning lights and indicators, etc.
3 Operation of each component	Opening and closing the doors and windows, adjustment before driving, etc.
4 Driving	Operations and advice which are necessary for driving
5 Interior features	Usage of the interior features, etc.
6 Maintenance and care	Caring for your vehicle and maintenance procedures
7 When trouble arises	What to do in case of malfunction or emergency
8 Vehicle specifications	Vehicle specifications, customizable features, etc.
Index	Search by symptom
	Search alphabetically

2 TABLE OF CONTENTS

For your information	8
Reading this manual	12
How to search	13
Pictorial index	14

1 For safety and security

1-1. For safe use	
Before driving	34
For safety drive	36
Seat belts	38
SRS airbags	43
Airbag manual on-off system	54
Safety information for children	56
Child restraint systems	57
Installing child restraints	66
Exhaust gas precautions	75
1-2. Hybrid system	
Hybrid system features	76
Hybrid system precautions	80
1-3. Theft deterrent system	
Immobilizer system	85
Double locking system	90
Alarm	91

2 Instrument cluster

2. Instrument cluster	
Warning lights and indicators	98
Gauges and meters	104
Multi-information display	111
Head-up display	119
Energy monitor/ consumption screen	126

3 Operation of each component

3-1. Key information	
Keys	134
3-2. Opening, closing and locking the doors and trunk	
Doors	139
Trunk	146
Smart entry & start system	153
3-3. Adjusting the seats	
Front seats	175
Driving position memory	178
Head restraints	183
3-4. Adjusting the steering wheel and mirrors	
Steering wheel	186
Inside rear view mirror	188
Outside rear view mirrors	190

3-5. Opening, closing the windows and moon roof

- Power windows..... 193
Moon roof..... 196

4 Driving

4-1. Before driving

- Driving the vehicle..... 200
Cargo and luggage..... 208
Trailer towing (vehicles without towing package)209
Trailer towing (vehicles with towing package)..... 210

4-2. Driving procedures

- Power (ignition) switch.....217
EV drive mode 222
Hybrid transmission 224
Turn signal lever 231
Parking brake232
Brake Hold.....235

4-3. Operating the lights and wipers

- Headlight switch.....237
AHS (Adaptive High-beam System)..... 241
Automatic High Beam 246
Fog light switch 250
Windshield wipers and washer..... 251

4-4. Refueling

- Opening the fuel tank cap..... 257

4-5. Using the driving support systems

- Lexus Safety System+ 261
PCS (Pre-Crash Safety system).....270
LKA (Lane-Keeping Assist).....282
RSA (Road Sign Assist)..... 291
Dynamic radar cruise control with full-speed range296
Cruise control 308
Driving mode select switch.....311
BSM (Blind Spot Monitor) 314
• The Blind Spot Monitor function..... 319
• The Rear Crossing Traffic Alert function 321
Driving assist systems.....324

4-6. Driving tips

- Hybrid vehicle driving tips..... 331
Winter driving tips334

5 Interior features

5-1. Remote Touch screen
 Remote Touch/12.3-inch display 340

5-2. Using the air conditioning system and defogger
 Front automatic air conditioning system.....346
 Rear air conditioning system 358
 Heated steering wheel/ seat heaters/ seat ventilators 361

5-3. Using the interior lights
 Interior lights list.....366
 • Interior lights367
 • Personal lights367

5-4. Using the storage features
 List of storage features369
 • Glove box370
 • Console box.....370
 • Cup holders 371
 • Auxiliary boxes373
 Trunk features.....374

5-5. Using the other interior features

Other interior features 377
 • Sun visors 377
 • Vanity mirrors 377
 • Clock.....378
 • Ashtrays.....378
 • Power outlets.....379
 • Armrest..... 380
 • Rear sunshade/ rear door sunshades 380
 • Coat hooks382
 • Assist grips..... 383
 ERA-GLONASS..... 384

6 Maintenance and care

6-1. Maintenance and care
 Cleaning and protecting the vehicle exterior..... 390
 Cleaning and protecting the vehicle interior394

6-2. Maintenance
 Maintenance requirements.....397

6-3. Do-it-yourself maintenance

Do-it-yourself service precautions399
 Hood 401
 Positioning a floor jack.....402
 Engine compartment..... 403
 12-volt battery..... 412
 Tires 416
 Tire inflation pressure.....429
 Wheels..... 431
 Air conditioning filter433
 Electronic key battery435
 Checking and replacing fuses 437
 Light bulbs.....442

7 When trouble arises

7-1. Essential information

Emergency flashers.....452
 If your vehicle has to be stopped in an emergency453

7-2. Steps to take in an emergency

If your vehicle needs to be towed.....454
 If you think something is wrong.....459
 If a warning light turns on or a warning buzzer sounds.....460
 If a warning message is displayed.....466
 If you have a flat tire (vehicles with spare tire) 498
 If you have a flat tire (vehicles without spare tire)..... 509
 If the hybrid system will not start.....523
 If the parking brake cannot be released.....525
 If the electronic key does not operate properly 527
 If the 12-volt battery is discharged 530
 If your vehicle overheats535
 If the vehicle becomes stuck.....542



8 Vehicle specifications

8-1. Specifications

Maintenance data
(fuel, oil level, etc.).....546
Fuel information..... 559

8-2. Customization

Customizable features 561

8-3. Initialization

Item to initialize576

Index

What to do if...
(Troubleshooting).....578
Alphabetical index..... 582

For information regarding the equipment listed below, refer to the “NAVIGATION AND MULTIMEDIA SYSTEM OWNER’S MANUAL”

- Audio system
- Lexus parking assist-sensor
- Navigation system
- Lexus parking assist monitor

Toyota Motor Europe NV/SA, Avenue du Bourget 60 - 1140 Brussels,
Belgium www.toyota-europe.com



For your information

Main Owner's Manual

Please note that this manual applies to all models and explains all equipment, including options. Therefore, you may find some explanations for equipment not installed on your vehicle.

All specifications provided in this manual are current at the time of printing. However, because of the Lexus policy of continual product improvement, we reserve the right to make changes at any time without notice.

Depending on specifications, the vehicle shown in the illustrations may differ from your vehicle in terms of color and equipment.

Accessories, spare parts and modification of your Lexus

Both genuine Lexus and a wide variety of other spare parts and accessories for Lexus vehicles are currently available on the market. Should it be determined that any of the genuine Lexus parts or accessories supplied with the vehicle need to be replaced, Lexus recommends that genuine Lexus parts or accessories, be used to replace them. Other parts or accessories of matching quality can also be used. Lexus cannot accept any liability or guarantee spare parts and accessories which are not genuine Lexus products, nor for replacement or installation involving such parts. In addition, damage or performance problems resulting from the use of non-genuine Lexus spare parts or accessories may not be covered under warranty.

Installation of an RF-transmitter system

The installation of an RF-transmitter system in your vehicle could affect electronic systems such as:

- Multiport fuel injection system/sequential multiport fuel injection system
- Dynamic radar cruise control with full-speed range system
- Cruise control system
- Anti-lock brake system
- Vehicle dynamics integrated management
- SRS airbag system
- Seat belt pretensioner system

Be sure to check with any authorized Lexus retailer or Lexus authorized repairer, or any reliable repairer for precautionary measures or special instructions regarding installation of an RF-transmitter system.

Further information regarding frequency bands, power levels, antenna positions and installation provisions for the installation of RF-transmitters, is available on request at any authorized Lexus retailer or Lexus authorized repairer, or any reliable repairer.

High voltage parts and cables on the hybrid vehicles emit approximately the same amount of electromagnetic waves as the conventional gasoline powered vehicles or home electronic appliances despite of their electromagnetic shielding.

Unwanted noise may occur in the reception of the radio frequency transmitter (RF-transmitter).

Scrapping of your Lexus

The SRS airbag and seat belt pretensioner devices in your Lexus contain explosive chemicals. If the vehicle is scrapped with the airbags and seat belt pretensioners left as they are, this may cause an accident such as fire. Be sure to have the systems of the SRS airbag and seat belt pretensioner removed and disposed of by a qualified service shop or by any authorized Lexus retailer or Lexus authorized repairer, or any reliable repairer before you scrap your vehicle.



Your vehicle contains batteries and/or accumulators. Do not discard them into the environment but cooperate with separate collection (Directive 2006/66/EC).

Noise levels inside the vehicle (GS450h only)

For Russia and Kazakhstan:

TECHNICAL REGULATION OF THE CUSTOMS UNION "ON THE SAFETY OF WHEELED VEHICLES" TR CU 018/2011 Attachment No.3, Section 2 (Requirements for vehicles concerning their interior noise), Table 2.1, Remarks 3

This vehicle may not be used for public purposes (as taxis, for example).

WARNING

■ General precautions while driving

Driving under the influence: Never drive your vehicle when under the influence of alcohol or drugs that have impaired your ability to operate your vehicle. Alcohol and certain drugs delay reaction time, impair judgment and reduce coordination, which could lead to an accident that could result in death or serious injury.

Defensive driving: Always drive defensively. Anticipate mistakes that other drivers or pedestrians might make and be ready to avoid accidents.

Driver distraction: Always give your full attention to driving. Anything that distracts the driver, such as adjusting controls, talking on a cellular phone or reading can result in a collision with resulting death or serious injury to you, your occupants or others.

■ General precaution regarding children's safety

Never leave children unattended in the vehicle, and never allow children to have or use the key.

Children may be able to start the vehicle or shift the vehicle into neutral. There is also a danger that children may injure themselves by playing with the windows, the moon roof, or other features of the vehicle. In addition, heat build-up or extremely cold temperatures inside the vehicle can be fatal to children.

Reading this manual



WARNING:

Explains something that, if not obeyed, could cause death or serious injury to people.



NOTICE:

Explains something that, if not obeyed, could cause damage to or a malfunction in the vehicle or its equipment.



... Indicates operating or working procedures. Follow the steps in numerical order.



Indicates the action (pushing, turning, etc.) used to operate switches and other devices.



Indicates the outcome of an operation (e.g. a lid opens).

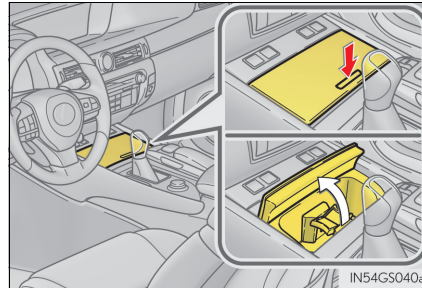

Indicates the component or position being explained.



Means "Do not", "Do not do this", or "Do not let this happen".

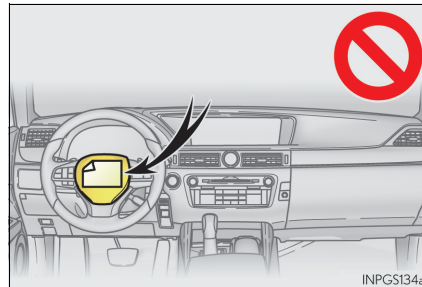

How to search

■ Searching by name

- Alphabetical index..... P. 582

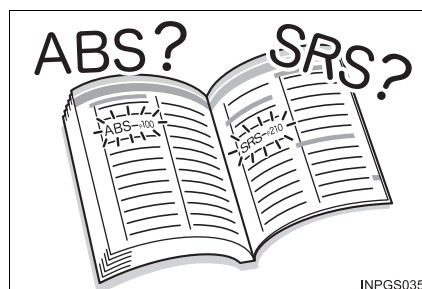

■ Searching by installation position

- Pictorial index..... P. 14

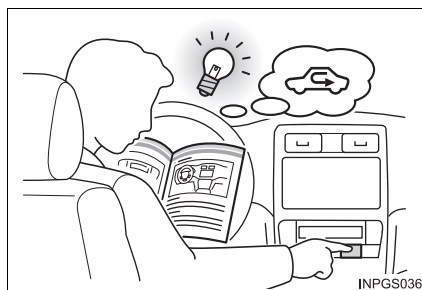

■ Searching by symptom or sound

- What to do if...
(Troubleshooting)..... P. 578



■ Searching by title

- Table of contents..... P. 2

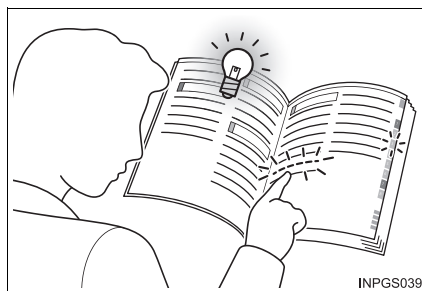

Pictorial index

■ Exterior

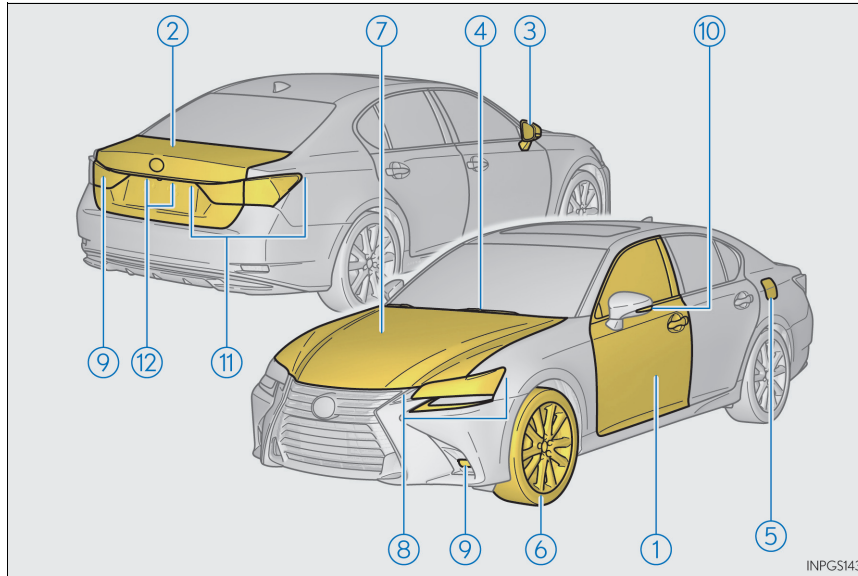

①	Doors	P. 139
	Locking/unlocking	P. 139
	Opening/closing the door glasses	P. 193
	Locking/unlocking by using the mechanical key	P. 527
	Warning messages	P. 468
②	Trunk	P. 146
	Opening from inside the cabin	P. 146
	Opening from outside	P. 146
	Opening by using the mechanical key	P. 527
	Warning messages	P. 468
③	Outside rear view mirrors	P. 190
	Adjusting the mirror angle	P. 190
	Folding the mirrors	P. 190
	Driving position memory	P. 178
	Defogging the mirrors	P. 352

④	Windshield wipers	P. 251
	Precautions against winter season.....	P. 334
	To prevent freezing (windshield wiper de-icer) ^{*1}	P. 352
	Precautions against car wash.....	P. 392
⑤	Fuel filler door	P. 257
	Refueling method.....	P. 257
	Fuel type/fuel tank capacity.....	P. 549
⑥	Tires	P. 416
	Tire size/inflation pressure.....	P. 555
	Winter tires/tire chain.....	P. 334
	Checking/rotation/tire pressure warning system ^{*1}	P. 416
	Coping with flat tires.....	P. 498, 509
⑦	Hood	P. 401
	Opening.....	P. 401
	Engine compartment cover.....	P. 405
	Engine oil.....	P. 550
	Coping with overheat.....	P. 535
	Warning messages.....	P. 468

Light bulbs of the exterior lights for driving
(Replacing method: P. 442, Watts: P. 558)

⑧	Headlights/front position lights/daytime running lights	P. 237
	Front turn signal lights.....	P. 231
⑨	Front fog lights/rear fog light^{*2}	P. 250
⑩	Side turn signal lights	P. 231
⑪	Tail lights	P. 237
	Stop lights	
	Emergency brake signal.....	P. 325
	Rear turn signal lights	P. 231
	Back-up light^{*2}	
	Shifting the shift lever to R.....	P. 224
⑫	License plate lights	P. 237

^{*1}: If equipped

^{*2}: They may be located on the opposite side depending on the target region.

■ Instrument panel (Left-hand drive vehicles)

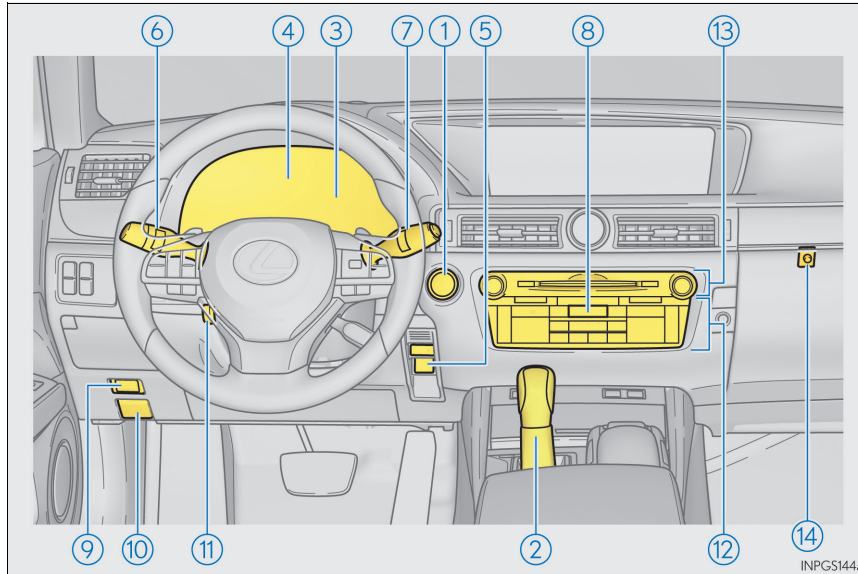

- | | | |
|---|---|---------------|
| ① | Power switch | P. 217 |
| | Starting the hybrid system/changing the modes | P. 217 |
| | Emergency stop of the hybrid system | P. 453 |
| | When the hybrid system will not start | P. 523 |
| | Warning messages | P. 477, 493 |
| ② | Shift lever | P. 224 |
| | Changing the shift position | P. 224 |
| | Precautions against towing | P. 454 |
| | When the shift lever does not move | P. 229 |
| ③ | Meters | P. 104 |
| | Reading the meters/adjusting the instrument panel light | P. 104 |
| | Warning lights/indicator lights | P. 98 |
| | When the warning lights come on | P. 460 |

④	Multi-information display	P. 111
	Display	P. 111
	Energy monitor	P. 126
	When the warning messages are displayed	P. 466
⑤	Parking brake switches	P. 232
	Applying/releasing	P. 232
	Precautions against winter season	P. 335
	Warning buzzer/message	P. 462, 472
⑥	Turn signal lever	P. 231
	Headlight switch	P. 237
	Headlights/front position lights/tail lights/daytime running lights	P. 237
	Front fog lights/rear fog light	P. 250
⑦	Windshield wiper and washer switch	P. 251
	Usage	P. 251
	Adding washer fluid	P. 411
	Headlight cleaners	P. 252, 254
	Warning messages	P. 486
⑧	Emergency flasher switch	P. 452
⑨	Trunk opener	P. 146
⑩	Hood lock release lever	P. 401
⑪	Tilt and telescopic steering control switch	P. 186
	Adjustment	P. 186
	Driving position memory	P. 178
⑫	Air conditioning system	P. 346
	Usage	P. 346
	Rear window defogger	P. 352
⑬	Audio system *	
⑭	Trunk opener main switch	P. 148

*: Refer to "NAVIGATION AND MULTIMEDIA SYSTEM OWNER'S MANUAL"

■ Switches (Left-hand drive vehicles)

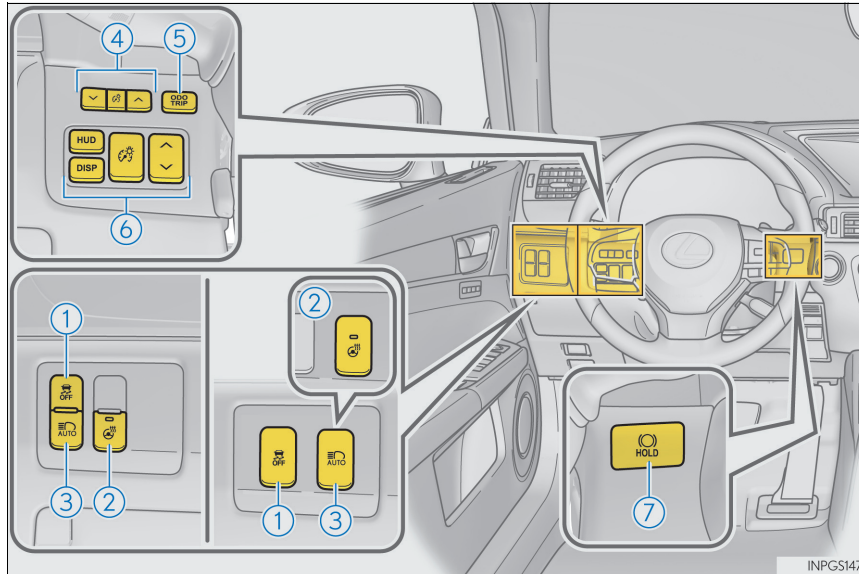

- | | |
|--|--------|
| ① VSC OFF switch..... | P. 326 |
| ② Heated steering wheel switch* | P. 362 |
| ③ Automatic High Beam switch* | P. 246 |
| Adaptive High-beam System switch* | P. 241 |
| ④ Instrument panel light control switches..... | P. 107 |
| ⑤ Odometer/trip meter and trip meter reset button..... | P. 107 |
| ⑥ HUD (Head-up display) switches* | P. 119 |
| ⑦ Brake hold switch..... | P. 235 |

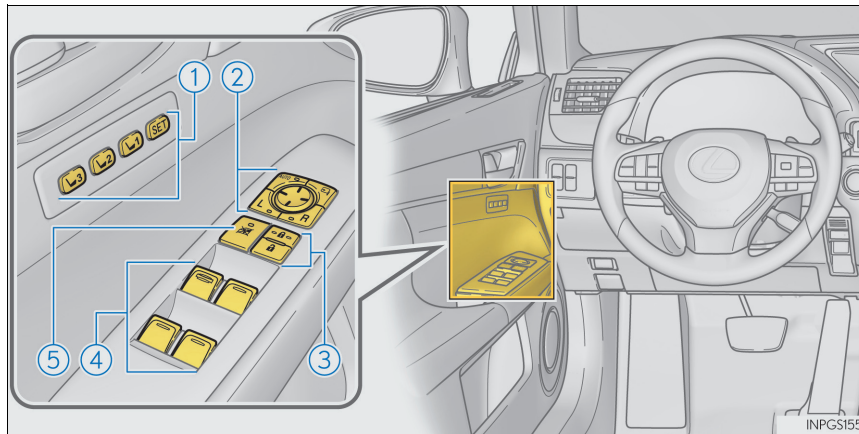

- ① Driving position memory switches P. 178
- ② Outside rear view mirror switches P. 190
- ③ Door lock switches P. 142
- ④ Power window switches P. 193
- ⑤ Window lock switch P. 193

* : If equipped

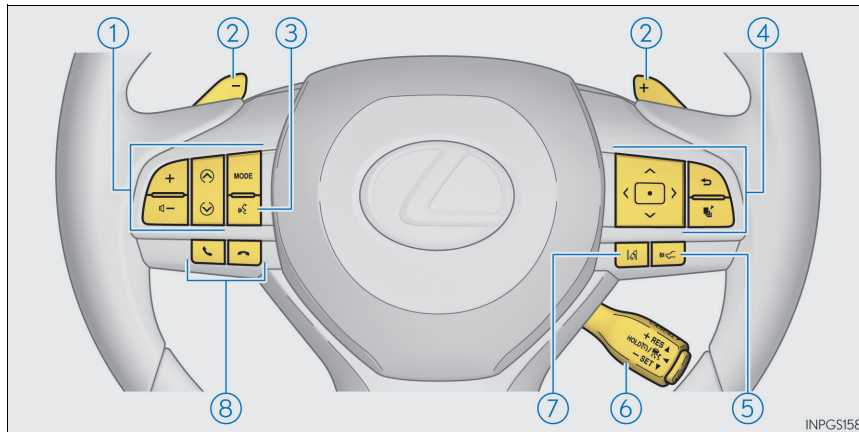

- ① Audio remote control switches *1
- ② Paddle shift switches P. 226
- ③ Talk switch *1
- ④ Meter control switches P. 112
- ⑤ Vehicle-to-vehicle distance button *2 P. 302
- ⑥ Cruise control switch
Cruise control *2 P. 308
Dynamic radar cruise control with full-speed range *2 P. 296
- ⑦ LKA (Lane-Keeping Assist) switch *2 P. 282
- ⑧ Telephone switches *1

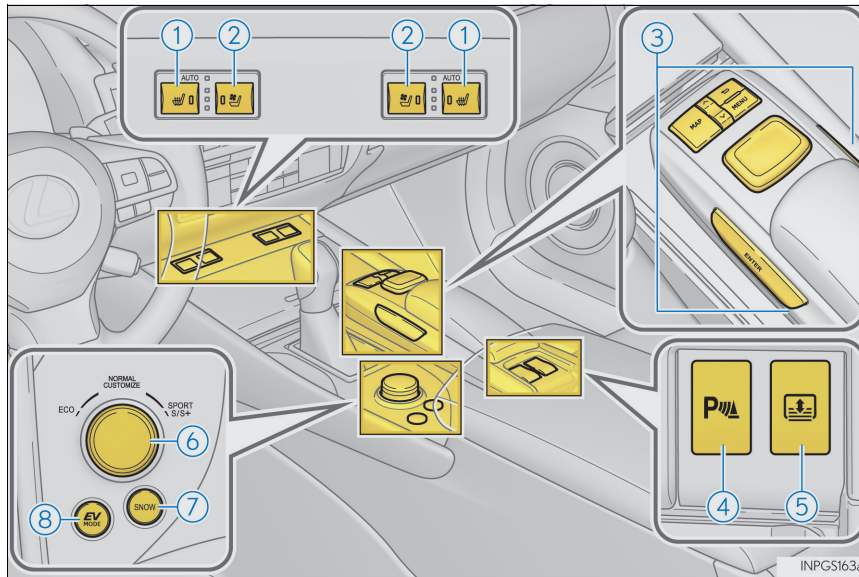

①	Seat heater switches *2	P. 362
②	Seat ventilator switches *2	P. 362
③	Remote Touch	P. 340
④	Lexus parking assist-sensor switch *1,2	
⑤	Rear sunshade switch *2	P. 380
⑥	Driving mode select switch	P. 311
⑦	Snow mode switch	P. 225
⑧	EV drive mode switch	P. 222

*1: Refer to "NAVIGATION AND MULTIMEDIA SYSTEM OWNER'S MANUAL".
 *2: If equipped

■ Interior (Left-hand drive vehicles)

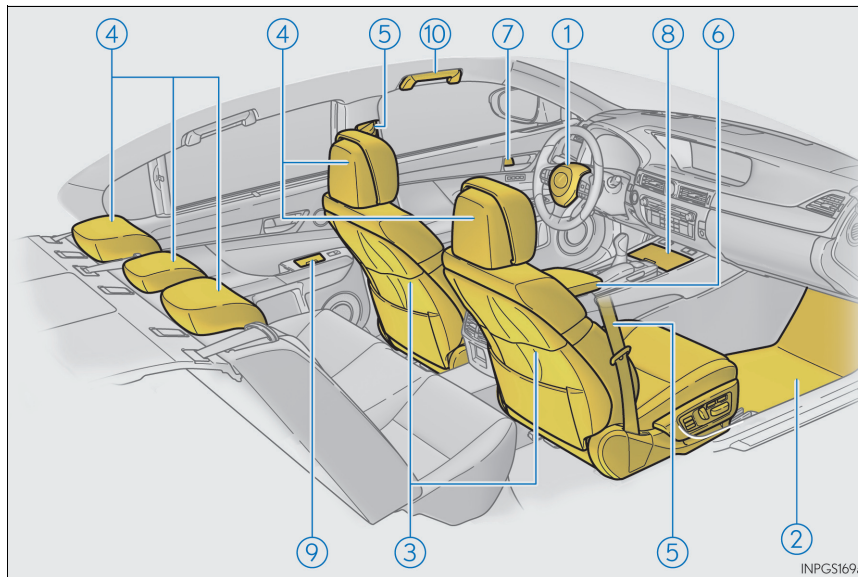

① SRS airbags.....	P. 43
② Floor mats	P. 34
③ Front seats	P. 175
④ Head restraints	P. 183
⑤ Seat belts	P. 38
⑥ Console box	P. 370
⑦ Inside lock buttons.....	P. 142
⑧ Cup holders	P. 371
⑨ Auxiliary boxes *1	P. 373
Ashtrays *1	P. 378
⑩ Assist grips.....	P. 383

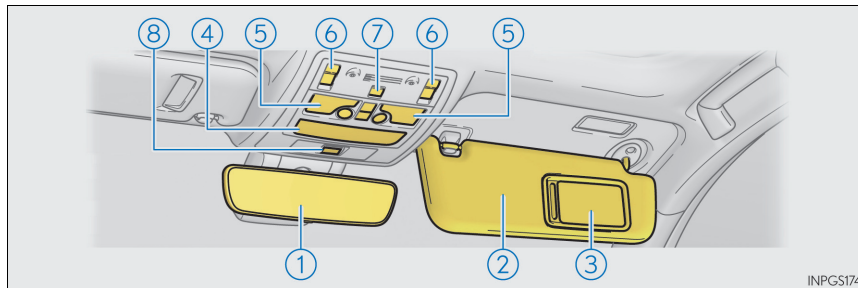

①	Inside rear view mirror	P. 188
②	Sun visors *2	P. 377
③	Vanity mirrors	P. 377
④	Interior light *3	P. 367
⑤	Personal lights *3	P. 367
⑥	Moon roof switches *1	P. 196
⑦	Intrusion sensor cancel switch *1	P. 94
	Intrusion sensor and tilt sensor cancel switch *1	P. 94
⑧	"SOS" button *1	P. 384

*1: If equipped

*2: NEVER use a rearward facing child restraint on a seat protected by an ACTIVE AIRBAG in front of it, DEATH or SERIOUS INJURY to the CHILD can occur. (→P. 73)



*3: The illustration shows the front, but they are also equipped in the rear.

■ Instrument panel (Right-hand drive vehicles)

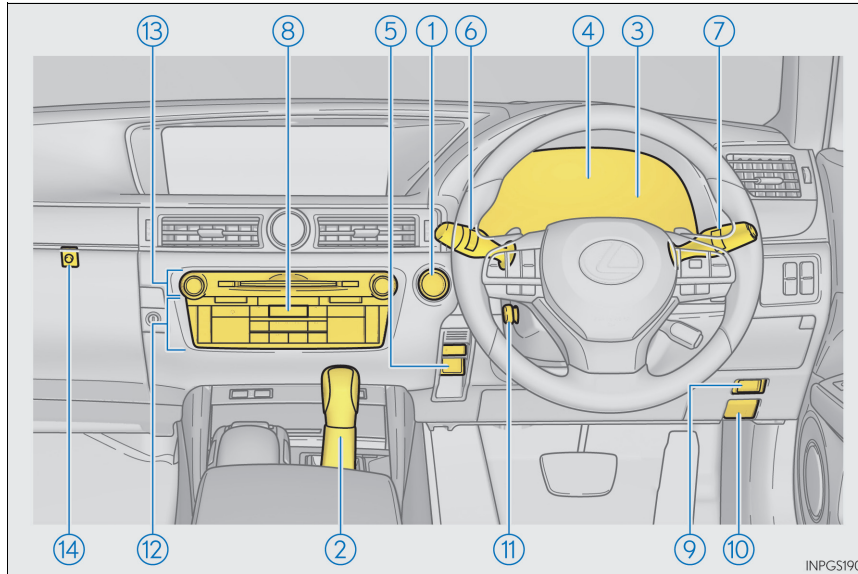

- | | | |
|---|---|---------------|
| ① | Power switch | P. 217 |
| | Starting the hybrid system/changing the modes | P. 217 |
| | Emergency stop of the hybrid system | P. 453 |
| | When the hybrid system will not start | P. 523 |
| | Warning messages | P. 477, 493 |
| ② | Shift lever | P. 224 |
| | Changing the shift position | P. 224 |
| | Precautions against towing | P. 454 |
| | When the shift lever does not move | P. 229 |
| ③ | Meters | P. 104 |
| | Reading the meters/adjusting the instrument panel light | P. 104 |
| | Warning lights/indicator lights | P. 98 |
| | When the warning lights come on | P. 460 |

④	Multi-information display	P. 111
	Display	P. 111
	Energy monitor	P. 126
	When the warning messages are displayed	P. 466
⑤	Parking brake switches	P. 232
	Applying/releasing	P. 232
	Precautions against winter season	P. 335
	Warning buzzer/message	P. 462, 472
⑥	Turn signal lever	P. 231
	Headlight switch	P. 237
	Headlights/front position lights/tail lights/daytime running lights	P. 237
	Front fog lights/rear fog light	P. 250
⑦	Windshield wiper and washer switch	P. 251
	Usage	P. 251
	Adding washer fluid	P. 411
	Headlight cleaners	P. 252, 254
	Warning messages	P. 486
⑧	Emergency flasher switch	P. 452
⑨	Trunk opener	P. 146
⑩	Hood lock release lever	P. 401
⑪	Tilt and telescopic steering control switch	P. 186
	Adjustment	P. 186
	Driving position memory	P. 178
⑫	Air conditioning system	P. 346
	Usage	P. 346
	Rear window defogger	P. 352
⑬	Audio system *	
⑭	Trunk opener main switch	P. 148

*: Refer to "NAVIGATION AND MULTIMEDIA SYSTEM OWNER'S MANUAL"

■ Switches (Right-hand drive vehicles)

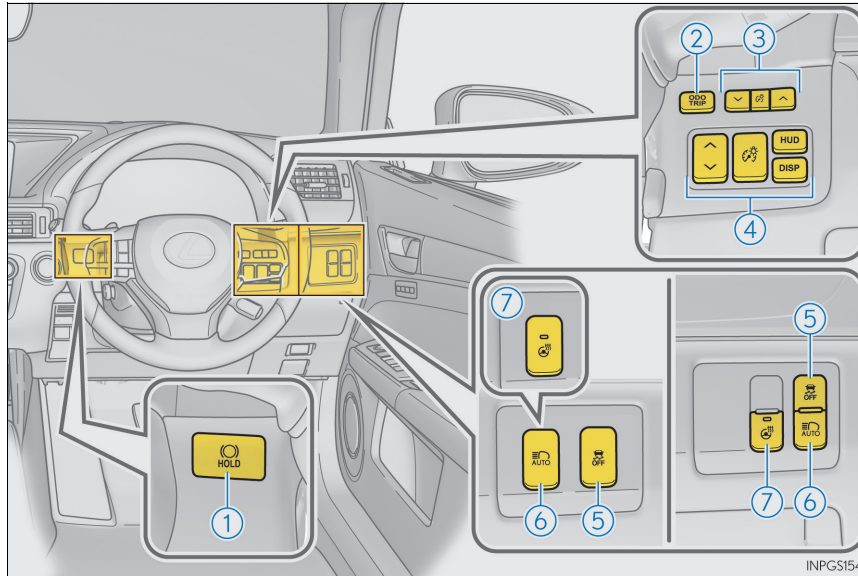

- ① Brake hold switch.....P. 235
- ② Odometer/trip meter and trip meter reset button..... P. 107
- ③ Instrument panel light control switches..... P. 107
- ④ HUD (Head-up display) switches* P. 119
- ⑤ VSC OFF switch.....P. 326
- ⑥ Automatic High Beam switch*P. 246
Adaptive High-beam System switch* P. 241
- ⑦ Heated steering wheel switch*P. 362

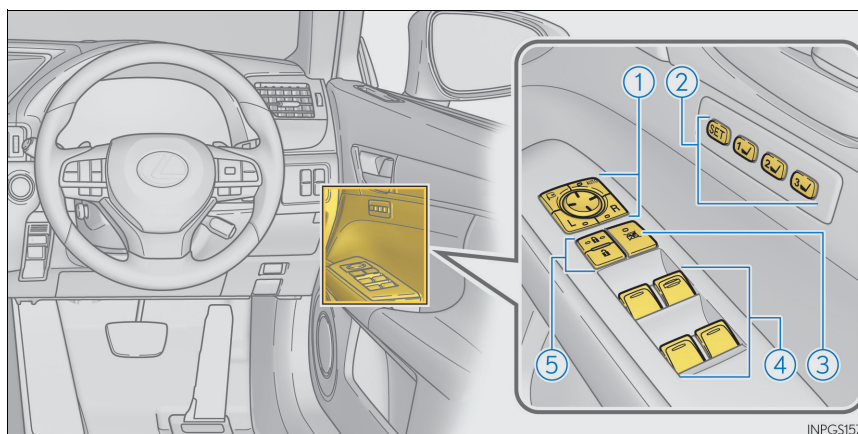

- ① Outside rear view mirror switches P. 190
- ② Driving position memory switches P. 178
- ③ Window lock switch P. 193
- ④ Power window switches P. 193
- ⑤ Door lock switches P. 142

* : If equipped

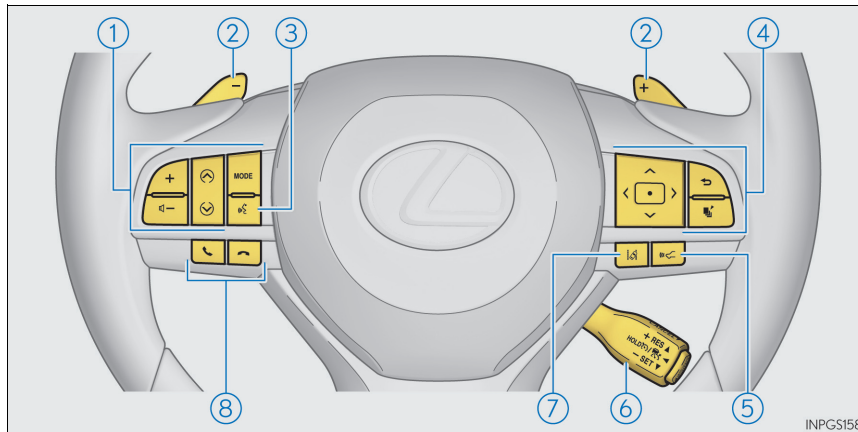

- ① Audio remote control switches *1
- ② Paddle shift switches P. 226
- ③ Talk switch *1
- ④ Meter control switches P. 112
- ⑤ Vehicle-to-vehicle distance button *2 P. 302
- ⑥ Cruise control switch
Cruise control *2 P. 308
Dynamic radar cruise control with full-speed range *2 P. 296
- ⑦ LKA (Lane-Keeping Assist) switch *2 P. 282
- ⑧ Telephone switches *1

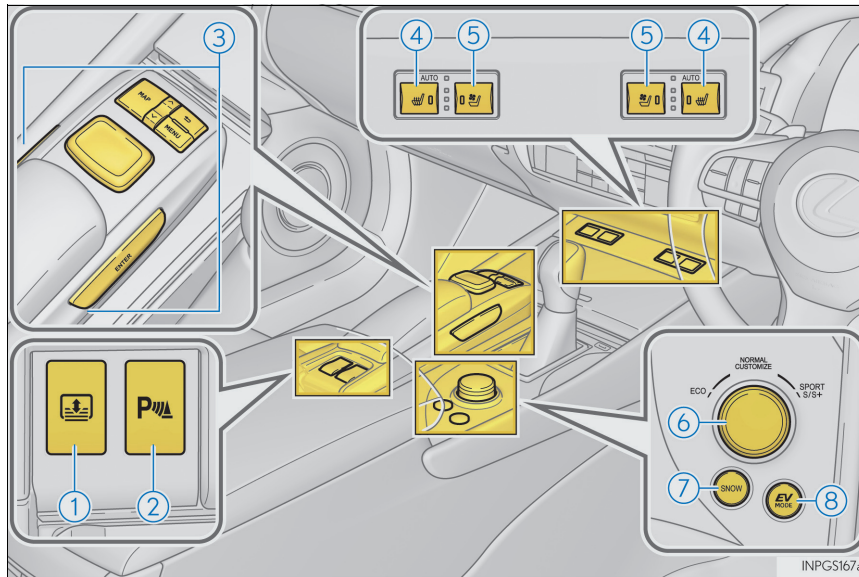

① Rear sunshade switch *2	P. 380
② Lexus parking assist-sensor switch *1,2	
③ Remote Touch	P. 340
④ Seat heater switches *2	P. 362
⑤ Seat ventilator switches *2	P. 362
⑥ Driving mode select switch	P. 311
⑦ Snow mode switch	P. 225
⑧ EV drive mode switch	P. 222

*1: Refer to "NAVIGATION AND MULTIMEDIA SYSTEM OWNER'S MANUAL".
 *2: If equipped

■ Interior (Right-hand drive vehicles)

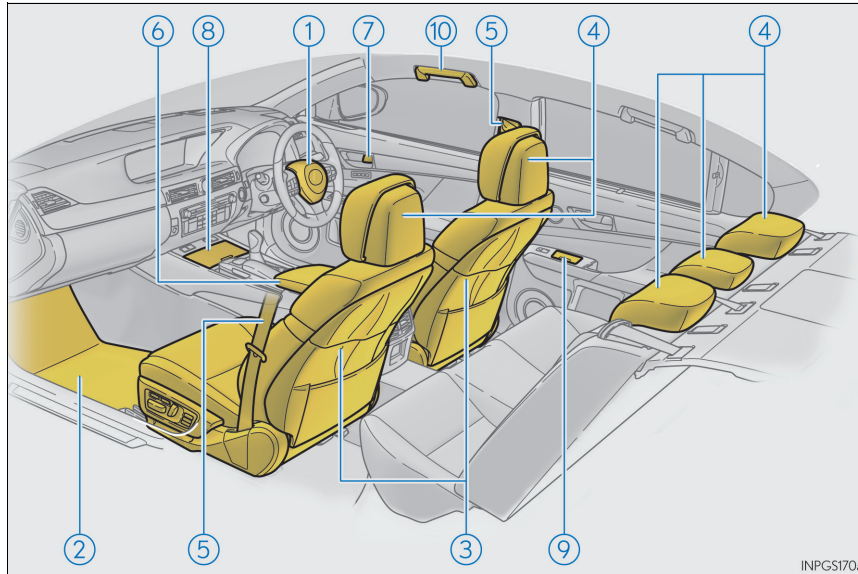

① SRS airbags.....	P. 43
② Floor mats	P. 34
③ Front seats	P. 175
④ Head restraints	P. 183
⑤ Seat belts	P. 38
⑥ Console box	P. 370
⑦ Inside lock buttons.....	P. 142
⑧ Cup holders	P. 371
⑨ Auxiliary boxes *1	P. 373
Ashtrays *1	P. 378
⑩ Assist grips.....	P. 383

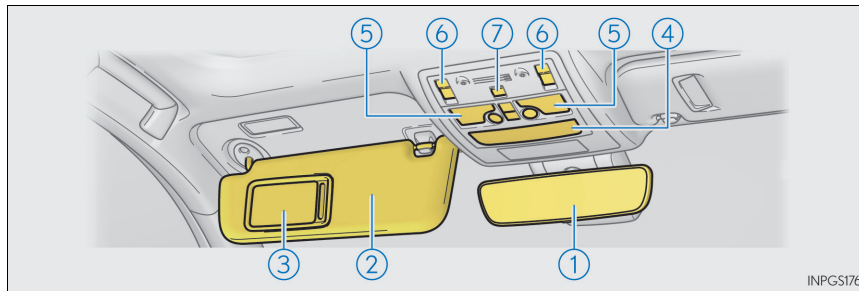

① Inside rear view mirror	P. 188
② Sun visors *2	P. 377
③ Vanity mirrors	P. 377
④ Interior light *3	P. 367
⑤ Personal lights *3	P. 367
⑥ Moon roof switches *1	P. 196
⑦ Intrusion sensor cancel switch *1	P. 94
Intrusion sensor and tilt sensor cancel switch *1	P. 94

*1: If equipped

*2: NEVER use a rearward facing child restraint on a seat protected by an ACTIVE AIRBAG in front of it, DEATH or SERIOUS INJURY to the CHILD can occur. (→P. 73)



*3: The illustration shows the front, but they are also equipped in the rear.

For safety and security**1**

- 1-1. For safe use**
 - Before driving..... 34
 - For safety drive 36
 - Seat belts 38
 - SRS airbags 43
 - Airbag manual on-off
system 54
 - Safety information
for children 56
 - Child restraint systems 57
 - Installing child restraints..... 66
 - Exhaust gas precautions..... 75
- 1-2. Hybrid system**
 - Hybrid system features 76
 - Hybrid system precautions.....80
- 1-3. Theft deterrent system**
 - Immobilizer system 85
 - Double locking system 90
 - Alarm 91

Before driving

Floor mat

Use only floor mats designed specifically for vehicles of the same model and model year as your vehicle. Fix them securely in place onto the carpet.

- 1 Insert the retaining hooks (clips) into the floor mat eyelets.

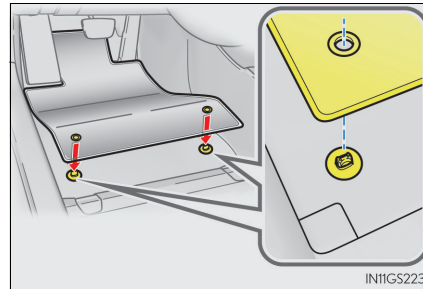

- 2 Turn the upper knob of each retaining hook (clip) to secure the floor mats in place.

*: Always align the \triangle marks.

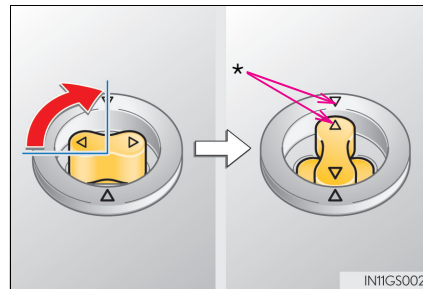

The shape of the retaining hooks (clips) may differ from that shown in the illustration.

⚠ WARNING

Observe the following precautions.

Failure to do so may cause the driver's floor mat to slip, possibly interfering with the pedals while driving. An unexpectedly high speed may result or it may become difficult to stop the vehicle. This could lead to an accident, resulting in death or serious injury.

■ When installing the driver's floor mat

- Do not use floor mats designed for other models or different model year vehicles, even if they are Lexus Genuine floor mats.
- Only use floor mats designed for the driver's seat.
- Always install the floor mat securely using the retaining hooks (clips) provided.
- Do not use two or more floor mats on top of each other.
- Do not place the floor mat bottom-side up or upside-down.

■ Before driving

- Check that the floor mat is securely fixed in the correct place with all the provided retaining hooks (clips). Be especially careful to perform this check after cleaning the floor.
- With the hybrid system stopped and the shift lever in P, fully depress each pedal to the floor to make sure it does not interfere with the floor mat.

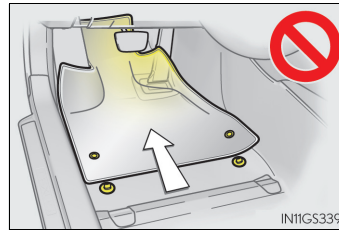

For safety drive

For safe driving, adjust the seat and mirror to an appropriate position before driving.

Correct driving posture

- ① Adjust the angle of the seatback so that you are sitting straight up and so that you do not have to lean forward to steer. (→P. 175)
- ② Adjust the seat so that you can depress the pedals fully and so that your arms bend slightly at the elbow when gripping the steering wheel. (→P. 175)
- ③ Lock the head restraint in place with the center of the head restraint closest to the top of your ears. (→P. 183)
- ④ Wear the seat belt correctly. (→P. 38)

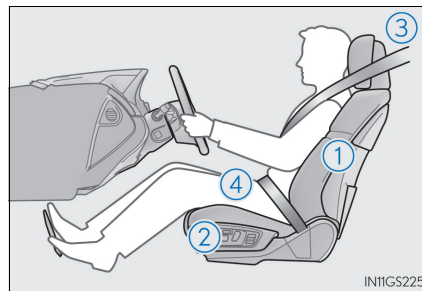

Correct use of the seat belts

Make sure that all occupants are wearing their seat belts before driving the vehicle. (→P. 38)

Use a child restraint system appropriate for the child until the child becomes large enough to properly wear the vehicle's seat belt. (→P. 57)

Adjusting the mirrors

Make sure that you can see backward clearly by adjusting the inside and outside rear view mirrors properly. (→P. 188, 190)

 **WARNING**

Observe the following precautions.

Failure to do so may result in death or serious injury.

- Do not adjust the position of the driver's seat while driving.
Doing so could cause the driver to lose control of the vehicle.
- Do not place a cushion between the driver or passenger and the seatback.
A cushion may prevent correct posture from being achieved, and reduce the effectiveness of the seat belt and head restraint.
- Do not place anything under the front seats.
Objects placed under the front seats may become jammed in the seat tracks and stop the seat from locking in place. This may lead to an accident and the adjustment mechanism may also be damaged.
- Always observe the legal speed limit when driving on public roads.
- When driving over long distances, take regular breaks before you start to feel tired.
Also, if you feel tired or sleepy while driving, do not force yourself to continue driving and take a break immediately.

Seat belts

Make sure that all occupants are wearing their seat belts before driving the vehicle.

Correct use of the seat belts

- Extend the shoulder belt so that it comes fully over the shoulder, but does not come into contact with the neck or slide off the shoulder.
- Position the lap belt as low as possible over the hips.
- Adjust the position of the seatback. Sit up straight and well back in the seat.
- Do not twist the seat belt.

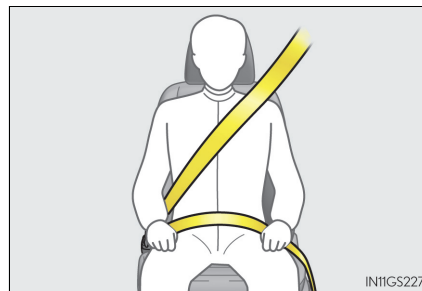

Fastening and releasing the seat belt

- ① To fasten the seat belt, push the plate into the buckle until a click sound is heard.
- ② To release the seat belt, press the release button.

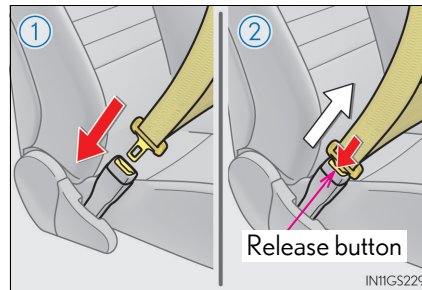

Adjusting the seat belt shoulder anchor height (front seats)

- ① Push the seat belt shoulder anchor down while pressing the release button.
 - ② Push the seat belt shoulder anchor up.
- Move the height adjuster up and down as needed until you hear a click.

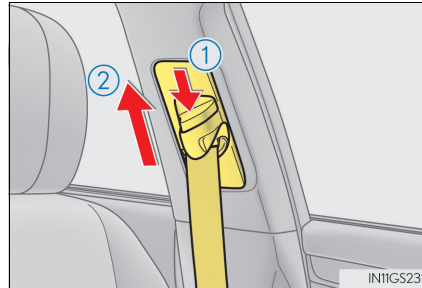

Seat belt comfort guide (outboard rear seats)

For children or smaller-than-average people, slide the seat belt comfort guide forward so that the shoulder belt does not sit close to the person's neck.

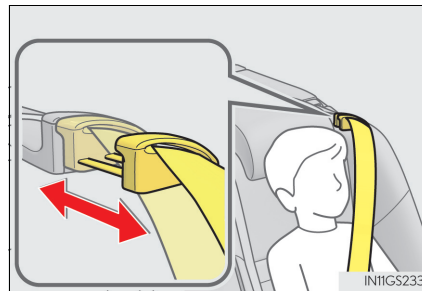

Seat belt pretensioners (front and outboard rear seats)

The pretensioner helps the seat belt to quickly restrain the occupant by retracting the seat belt when the vehicle is subjected to certain types of severe frontal collision.

The front seat pretensioners also activate when the vehicle is subjected to certain types of severe side collision.

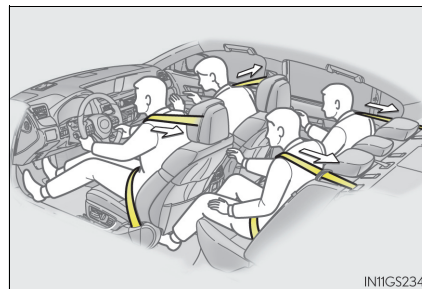

The pretensioner does not activate in the event of a minor frontal impact, a minor side impact, a rear impact or a vehicle rollover.

■ Emergency locking retractor (ELR)

The retractor will lock the belt during a sudden stop or on impact. It may also lock if you lean forward too quickly. A slow, easy motion will allow the belt to extend so that you can move around fully.

■ Child seat belt usage

The seat belts of your vehicle were principally designed for persons of adult size.

- Use a child restraint system appropriate for the child, until the child becomes large enough to properly wear the vehicle's seat belt. (→P. 57)
- When the child becomes large enough to properly wear the vehicle's seat belt, follow the instructions regarding seat belt usage. (→P. 38)

■ Replacing the belt after the pretensioner has been activated

If the vehicle is involved in multiple collisions, the pretensioner will activate for the first collision, but will not activate for the second or subsequent collisions.

■ Seat belt regulations

If seat belt regulations exist in the country where you reside, please contact any authorized Lexus retailer or Lexus authorized repairer, or any reliable repairer for seat belt replacement or installation.

⚠ WARNING

Observe the following precautions to reduce the risk of injury in the event of sudden braking, sudden swerving or an accident.
Failure to do so may cause death or serious injury.

■ Wearing a seat belt

- Ensure that all passengers wear a seat belt.
- Always wear a seat belt properly.
- Each seat belt should be used by one person only. Do not use a seat belt for more than one person at once, including children.
- Lexus recommends that children be seated in the rear seat and always use a seat belt and/or an appropriate child restraint system.
- To achieve a proper seating position, do not recline the seat more than necessary. The seat belt is most effective when the occupants are sitting up straight and well back in the seats.
- Do not wear the shoulder belt under your arm.
- Always wear your seat belt low and snug across your hips.

■ Pregnant women

Obtain medical advice and wear the seat belt in the proper way. (→P. 38)

Women who are pregnant should position the lap belt as low as possible over the hips in the same manner as other occupants, extending the shoulder belt completely over the shoulder and avoiding belt contact with the rounding of the abdominal area.

If the seat belt is not worn properly, not only the pregnant woman, but also the fetus could suffer death or serious injury as a result of sudden braking or a collision.

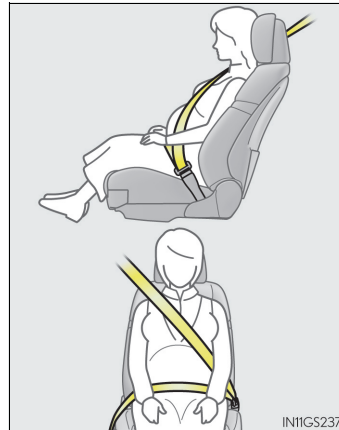

**WARNING****■ People suffering illness**

Obtain medical advice and wear the seat belt in the proper way. (→P. 38)

■ When children are in the vehicle

Do not allow children to play with the seat belt. If the seat belt becomes twisted around a child's neck, it may lead to choking or other serious injuries that could result in death. If this occurs and the buckle cannot be unfastened, scissors should be used to cut the belt.

■ Seat belt pretensioners

If the pretensioner has activated, the SRS warning light will come on. In that case, the seat belt cannot be used again and must be replaced at any authorized Lexus retailer or Lexus authorized repairer, or any reliable repairer.

■ Adjustable shoulder anchor

Always make sure the shoulder belt is positioned across the center of your shoulder. The belt should be kept away from your neck, but not falling off your shoulder. Failure to do so could reduce the amount of protection in an accident and cause death or serious injuries in the event of a sudden stop, sudden swerve or accident. (→P. 39)

■ Seat belt damage and wear

- Do not damage the seat belts by allowing the belt, plate, or buckle to be jammed in the door.
- Inspect the seat belt system periodically. Check for cuts, fraying, and loose parts. Do not use a damaged seat belt until it is replaced. Damaged seat belts cannot protect an occupant from death or serious injury.
- Ensure that the belt and plate are locked and the belt is not twisted.
If the seat belt does not function correctly, immediately contact any authorized Lexus retailer or Lexus authorized repairer, or any reliable repairer.
- Replace the seat assembly, including the belts, if your vehicle has been involved in a serious accident, even if there is no obvious damage.
- Do not attempt to install, remove, modify, disassemble or dispose of the seat belts. Have any necessary repairs carried out by any authorized Lexus retailer or Lexus authorized repairer, or any reliable repairer. Inappropriate handling may lead to incorrect operation.

SRS airbags

The SRS airbags inflate when the vehicle is subjected to certain types of severe impacts that may cause significant injury to the occupants. They work together with the seat belts to help reduce the risk of death or serious injury.

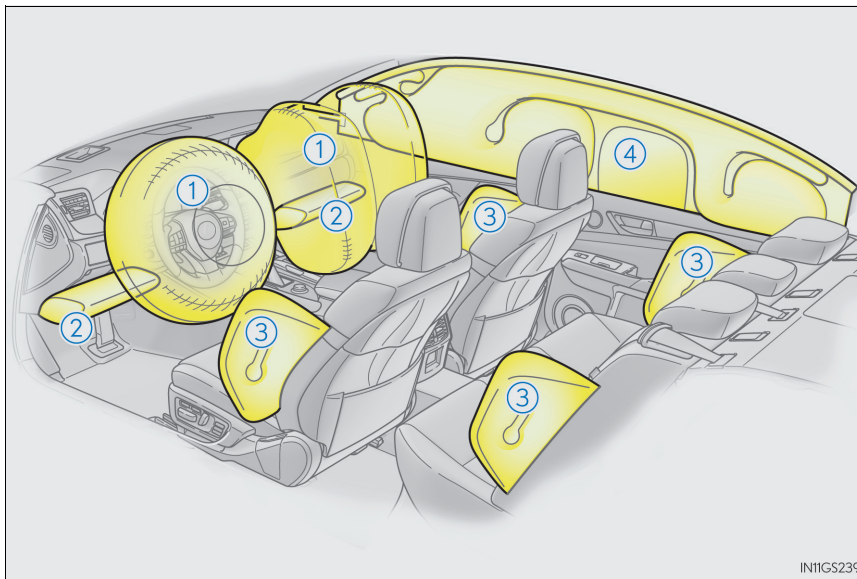

◆ SRS front airbags

- ① SRS driver airbag/front passenger airbag
Can help protect the head and chest of the driver and front passenger from impact with interior components
- ② SRS knee airbags
Can help provide driver and front passenger protection
An SRS knee airbag for the front passenger's seat is built into the glove box door.

◆ SRS side and curtain shield airbags

- ③ SRS front side airbags
Can help protect the torso of the front seat occupants
- SRS rear side airbags
Can help protect the torso of occupants in the rear outer seats
- ④ SRS curtain shield airbags
Can help protect primarily the head of occupants in the outer seats

SRS airbag system components

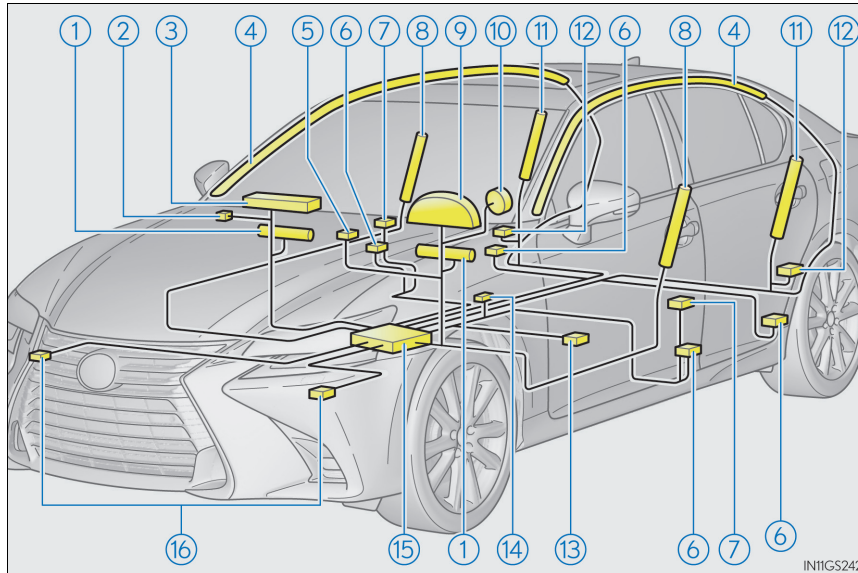

- | | |
|--|------------------------------------|
| ① Knee airbags | ⑨ SRS warning light |
| ② Airbag manual on-off switch | ⑩ Driver airbag |
| ③ Front passenger airbag | ⑪ Rear side airbags |
| ④ Curtain shield airbags | ⑫ Side impact sensors (rear) |
| ⑤ "PASSENGER AIR BAG" indicator lights | ⑬ Driver's seat position sensor |
| ⑥ Seat belt pretensioners and force limiters | ⑭ Driver's seat belt buckle switch |
| ⑦ Side impact sensors (front) | ⑮ Airbag sensor assembly |
| ⑧ Front side airbags | ⑯ Front impact sensors |

The main SRS airbag system components are shown above. The SRS airbag system is controlled by the airbag sensor assembly. As the airbags deploy, a chemical reaction in the inflators quickly fills the airbags with non-toxic gas to help restrain the motion of the occupants.

 **WARNING****■ SRS airbag precautions**

Observe the following precautions regarding the SRS airbags. Failure to do so may cause death or serious injury.

- The driver and all passengers in the vehicle must wear their seat belts properly. The SRS airbags are supplemental devices to be used with the seat belts.
- The SRS driver airbag deploys with considerable force, and can cause death or serious injury especially if the driver is very close to the airbag.

Since the risk zone for the driver's airbag is the first 50 - 75 mm (2 - 3 in.) of inflation, placing yourself 250 mm (10 in.) from your driver airbag provides you with a clear margin of safety. This distance is measured from the center of the steering wheel to your breastbone. If you sit less than 250 mm (10 in.) away now, you can change your driving position in several ways:

- Move your seat to the rear as far as you can while still reaching the pedals comfortably.
- Slightly recline the back of the seat.
Although vehicle designs vary, many drivers can achieve the 250 mm (10 in.) distance, even with the driver seat all the way forward, simply by reclining the back of the seat somewhat. If reclining the back of your seat makes it hard to see the road, raise yourself by using a firm, non-slippery cushion, or raise the seat if your vehicle has that feature.
- If your steering wheel is adjustable, tilt it downward. This points the airbag toward your chest instead of your head and neck.

The seat should be adjusted as recommended above, while still maintaining control of the foot pedals, steering wheel, and your view of the instrument panel controls.

⚠ WARNING

■ **SRS airbag precautions**

- The SRS front passenger airbag also deploys with considerable force, and can cause death or serious injury especially if the front passenger is very close to the airbag. The front passenger seat should be as far from the airbag as possible with the seatback adjusted, so the front passenger sits upright.
- Improperly seated and/or restrained infants and children can be killed or seriously injured by a deploying airbag. An infant or child who is too small to use a seat belt should be properly secured using a child restraint system. Lexus strongly recommends that all infants and children be placed in the rear seats of the vehicle and properly restrained. The rear seats are safer for infants and children than the front passenger seat. (→P. 57)
- Do not sit on the edge of the seat or lean against the dashboard.



- Do not allow a child to stand in front of the SRS front passenger airbag unit or sit on the knees of a front passenger.
- Do not allow the front seat occupants to hold items on their knees.



- Do not lean against the door, the roof side rail or the front, side and rear pillars.



⚠ WARNING

■ **SRS airbag precautions**

- Do not allow anyone to kneel on the passenger seat toward the door or put their head or hands outside the vehicle.



- Do not attach anything to or lean anything against areas such as the dashboard, steering wheel pad, lower portion of the instrument panel and door of the glove box. These items can become projectiles when the SRS driver, front passenger and knee airbags deploy.

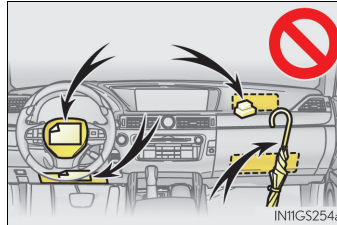

- Do not attach anything to areas such as a door, windshield glass, side door glass, front or rear pillar, roof side rail and assist grip. (Except for the speed limit sticker →P. 516)

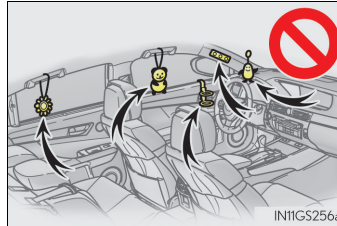

- Do not hang coat hangers or other hard objects on the coat hooks. All of these items could become projectiles and may cause death or serious injury, should the SRS curtain shield airbags deploy.
- If a vinyl cover is put on the area where the SRS knee airbag will deploy, be sure to remove it.
- Do not use seat accessories which cover the parts where the SRS side airbags inflate as they may interfere with inflation of the airbags. Such accessories may prevent the side airbags from activating correctly, disable the system or cause the side airbags to inflate accidentally, resulting in death or serious injury.

 **WARNING****■ SRS airbag precautions**

- Do not strike or apply significant levels of force to the area of the SRS airbag components. Doing so can cause the SRS airbags to malfunction.
- Do not touch any of the component parts immediately after the SRS airbags have deployed (inflated) as they may be hot.
- If breathing becomes difficult after the SRS airbags have deployed, open a door or window to allow fresh air in, or leave the vehicle if it is safe to do so. Wash off any residue as soon as possible to prevent skin irritation.
- If the areas where the SRS airbags are stored, such as the steering wheel pad, door of the glove box and front and rear pillar garnishes are damaged or cracked, have them replaced by any authorized Lexus retailer or Lexus authorized repairer, or any reliable repairer.

■ Modification and disposal of SRS airbag system components

Do not dispose of your vehicle or perform any of the following modifications without consulting any authorized Lexus retailer or Lexus authorized repairer, or any reliable repairer. The SRS airbags may malfunction or deploy (inflate) accidentally, causing death or serious injury.

- Installation, removal, disassembly and repair of the SRS airbags
- Repairs, modifications, removal or replacement of the steering wheel, instrument panel, dashboard, glove box, seats or seat upholstery, front, side and rear pillars or roof side rails
- Repairs or modifications of the front fender, front bumper, or side of the occupant compartment
- Installation of a grille guard (bull bars, kangaroo bar, etc.), snow plows or winches
- Modifications to the vehicle's suspension system
- Installation of electronic devices such as mobile two-way radios (RF-transmitter) and CD players
- Modifications to your vehicle for a person with a physical disability

■ If the SRS airbags deploy (inflate)

- Slight abrasions, burns, bruising etc., may be sustained from SRS airbags, due to the extremely high speed deployment (inflation) by hot gases.
- A loud noise and white powder will be emitted.
- Parts of the airbag module (steering wheel hub, airbag cover and inflator) as well as the seats, the glove box, parts of the front and rear pillars, and roof side rails may be hot for several minutes. The airbag itself may also be hot.
- The windshield may crack.
- Vehicles with ERA-GLONASS: If the SRS airbags deploy, the system is designed to send an emergency call* to the Public Safety Answering Point (PSAP), notifying them of the vehicle's location (without needing to push the "SOS" button) and an agent will attempt to speak with the occupants to ascertain the level of emergency and assistance required. If the occupants are unable to communicate, the agent automatically treats the call as an emergency and helps to dispatch the necessary emergency services. (→P. 384)

*: In some cases, the call cannot be made. (→P. 386)

■ SRS airbag deployment conditions (SRS front airbags)

- The SRS front airbags will deploy in the event of an impact that exceeds the set threshold level (the level of force corresponding to an approximately 20 - 30 km/h [12 - 18 mph] frontal collision with a fixed wall that does not move or deform).
However, this threshold velocity will be considerably higher in the following situations:
 - If the vehicle strikes an object, such as a parked vehicle or sign pole, which can move or deform on impact
 - If the vehicle is involved in an underride collision, such as a collision in which the front of the vehicle "underrides", or goes under, the bed of a truck
- Depending on the type of collision, it is possible that only the seat belt pretensioners will activate.

■ SRS airbag deployment conditions (SRS side and curtain shield airbags)

- The SRS side and curtain shield airbags will deploy in the event of an impact that exceeds the set threshold level (the level of force corresponding to the impact force produced by an approximately 1500 kg [3300 lb.] vehicle colliding with the vehicle cabin from a direction perpendicular to the vehicle orientation at an approximate speed of 20 - 30 km/h [12 - 18 mph]).
- The SRS side and curtain shield airbags may also deploy in the event of a severe frontal collision.

■ Conditions under which the SRS airbags may deploy (inflate), other than a collision

The SRS front airbags, SRS side and curtain shield airbags may also deploy if a serious impact occurs to the underside of your vehicle. Some examples are shown in the illustration.

- Hitting a curb, edge of pavement or hard surface
- Falling into or jumping over a deep hole
- Landing hard or falling

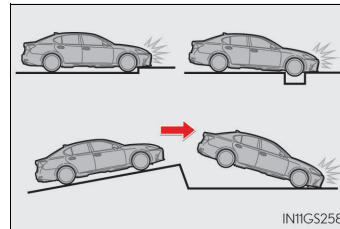
**■ Types of collisions that may not deploy the SRS airbags (SRS front airbags)**

The SRS front airbags do not generally inflate if the vehicle is involved in a side or rear collision, if it rolls over, or if it is involved in a low-speed frontal collision. But, whenever a collision of any type causes sufficient forward deceleration of the vehicle, deployment of the SRS front airbags may occur.

- Collision from the side
- Collision from the rear
- Vehicle rollover

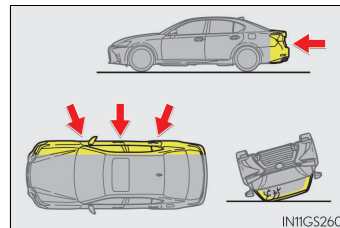

■ **Types of collisions that may not deploy the SRS airbags (SRS side and curtain shield airbags)**

The SRS side and curtain shield airbags may not activate if the vehicle is subjected to a collision from the side at certain angles, or a collision to the side of the vehicle body other than the passenger compartment.

- Collision from the side to the vehicle body other than the passenger compartment
- Collision from the side at an angle

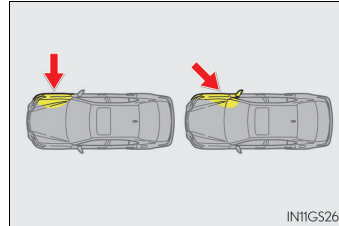

The SRS side and curtain shield airbags do not generally inflate if the vehicle is involved in a rear collision, if it rolls over, or if it is involved in a low-speed side or low-speed frontal collision.

- Collision from the rear
- Vehicle rollover

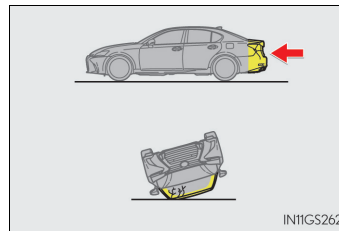

■ **When to contact any authorized Lexus retailer or Lexus authorized repairer, or any reliable repairer**

In the following cases, the vehicle will require inspection and/or repair. Contact any authorized Lexus retailer or Lexus authorized repairer, or any reliable repairer as soon as possible.

- Any of the SRS airbags have been inflated.
- The front of the vehicle is damaged or deformed, or was involved in an accident that was not severe enough to cause the SRS front airbags to inflate.

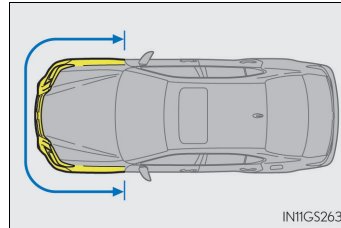

- A portion of a door or its surrounding area is damaged or deformed, or the vehicle was involved in an accident that was not severe enough to cause the SRS side and curtain shield airbags to inflate.

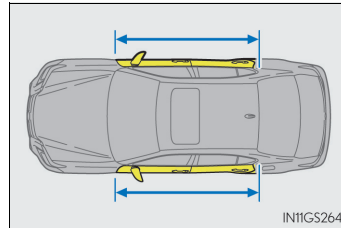

- The pad section of the steering wheel, dashboard near the front passenger airbag, lower portion of the instrument panel or door of the glove box is scratched, cracked, or otherwise damaged.

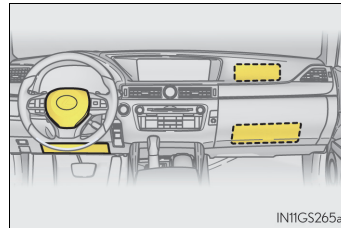

- The surface of the seats with the side airbag is scratched, cracked, or otherwise damaged.

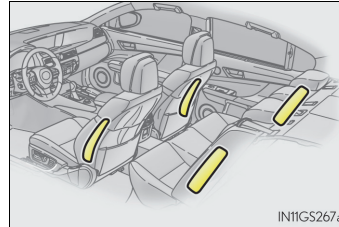

- The portion of the front pillars, rear pillars or roof side rail garnishes (padding) containing the curtain shield airbags inside is scratched, cracked, or otherwise damaged.

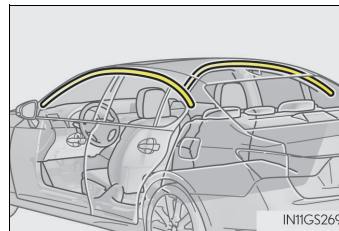

Airbag manual on-off system

This system deactivates the front passenger airbag, front passenger knee airbag and front passenger side airbag.

Only deactivate the airbags when using a child restraint system on the front passenger seat.

① “PASSENGER AIR BAG” indicator

This indicator light turns on when the airbag system is on (only when the power switch is in ON mode).

② Airbag manual on-off switch

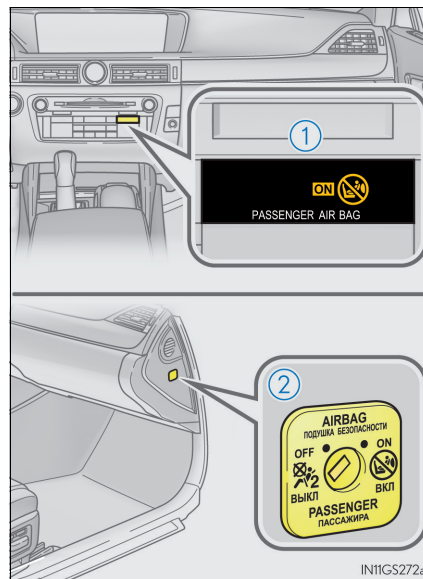

Deactivating the front seat passenger airbag, front passenger knee airbag and front passenger side airbag

Insert the mechanical key into the cylinder and rotate to the "OFF" position.

The "OFF" indicator light turns on (only when the power switch is in ON mode).

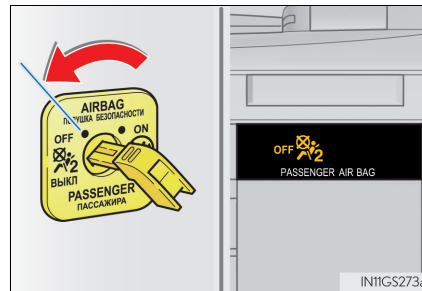

■ "PASSENGER AIR BAG" indicator information

If any of the following problems occur, it is possible that there is a malfunction in the system. Have the vehicle inspected by any authorized Lexus retailer or Lexus authorized repairer, or any reliable repairer.

- Neither "ON" nor "OFF" comes on.
- The indicator light does not change when the airbag manual on-off switch is switched to "ON" or "OFF".

⚠ WARNING

■ When installing a child restraint system

For safety reasons, always install a child restraint system in a rear seat. In the event that the rear seat cannot be used, the front seat can be used as long as the airbag manual on-off system is set to off.

If the airbag manual on-off system is left on, the strong impact of the airbag deployment (inflation) may cause serious injury or even death.

■ When a child restraint system is not installed on the front passenger seat

Ensure that the airbag manual on-off system is set to on.

If it is left off, the airbag may not deploy in the event of an accident, which may result in serious injury or even death.

Safety information for children

Observe the following precautions when children are in the vehicle.

Use a child restraint system appropriate for the child, until the child becomes large enough to properly wear the vehicle's seat belt.

- It is recommended that children sit in the rear seats to avoid accidental contact with the shift lever, wiper switch etc.
- Use the rear door child-protector lock or the window lock switch to avoid children opening the door while driving or operating the power window accidentally. (→P. 143, 193)
- Do not let small children operate equipment which may catch or pinch body parts, such as the power window, hood, trunk, seats etc.

WARNING

Never leave children unattended in the vehicle, and never allow children to have or use the key.

Children may be able to start the vehicle or shift the vehicle into neutral. There is also a danger that children may injure themselves by playing with the windows, the moon roof (if equipped) or other features of the vehicle. In addition, heat build-up or extremely cold temperatures inside the vehicle can be fatal to children.

Child restraint systems

Lexus strongly urges the use of child restraint systems.

Points to remember

Studies have shown that installing a child restraint on a rear seat is much safer than installing one on the front passenger seat.

- Choose a child restraint system that suits your vehicle and is appropriate to the age and size of the child.
- For installation details, follow the instructions provided with the child restraint system.
General installation instructions are provided in this manual. (→P. 66)
- If child restraint system regulations exist in the country where you reside, please contact any authorized Lexus retailer or Lexus authorized repairer, or any reliable repairer for the child restraint system installation.
- Lexus recommends that you use a child restraint system which conforms to the regulation ECE No.44.

1

For safety and security

Types of child restraints

Child restraint systems are classified into the following 5 groups according to the regulation ECE No.44:

Group 0: Up to 10 kg (22 lb.) (0 - 9 months)

Group 0+: Up to 13 kg (28 lb.) (0 - 2 years)

Group I: 9 to 18 kg (20 to 39 lb.) (9 months - 4 years)

Group II: 15 to 25 kg (34 to 55 lb.) (4 years - 7 years)

Group III: 22 to 36 kg (49 to 79 lb.) (6 years - 12 years)

In this owner's manual, the following 3 types of popular child restraint systems that can be secured with the seat belts are explained:

► Baby seat

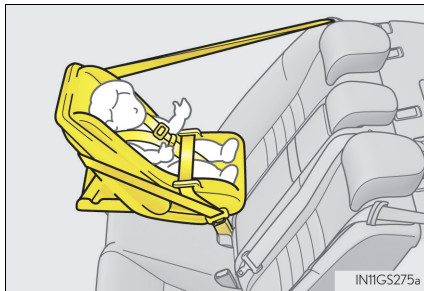

Equal to Group 0 and 0+ of ECE No.44

► Child seat



Equal to Group 0+ and I of ECE No.44

► Junior seat



Equal to Group II and III of ECE No.44

Child restraint system suitability for various seating positions

Information provided in the table shows your child restraint system suitability for various seating positions.

Seating position Mass groups	Front passenger seat		Rear seat	
	Airbag manual on-off switch		Outboard	Center
	ON	OFF		
0 Up to 10 kg (22 lb.) (0 - 9 months)	X	U*1	U, L	X
0+ Up to 13 kg (28 lb.) (0 - 2 years)	X	U*1	U, L	X
I 9 to 18 kg (20 to 39 lb.) (9 months - 4 years)	Rear-facing – X	U*1	U*2	X
	Forward-facing – UF*1			
II, III 15 to 36 kg (34 to 79 lb.) (4 - 12 years)	UF*1	U*1	U*2	X

1

For safety and security

Key of letters inserted in the above table:

U: Suitable for “universal” category child restraint systems approved for use in this mass group.

UF: Suitable for forward-facing “universal” category child restraint systems approved for use in this mass group.

L: Suitable for child restraint systems shown in the child restraint system list.

X: Not suitable seat position for children in this mass group.

*1: Adjust the front seatback to the most upright position. Move the front seat to the rear-most position.

If the head restraint interferes with your child restraint system, and the head restraint can be removed, remove the head restraint.

If the passenger seat is equipped with a vertical height adjuster, it must be placed in the upper most position.

Follow these procedures:

- For installing a baby seat with support base
If the baby seat interferes with the seatback when latching the baby seat into the support base, adjust the seatback rearward until there is no interference.
- For installing a forward-facing child seat
If there is gap between the child seat and the seatback, tilt the seatback rearward until good contact is achieved.
If the seat belt shoulder anchor is ahead of the child seat belt guide, move the seat cushion forward.
- For installing a junior seat
If the child in your child restraint system is in a very upright position, adjust the seatback to the most comfortable position.
If the seat belt shoulder anchor is ahead of the child seat belt guide, move the seat cushion forward.

*2: If the head restraint interferes with your child restraint system, and the head restraint can be removed, remove the head restraint.

The child restraint systems mentioned in the table may not be available outside of the EU area.

Other child restraint systems which are different from the systems mentioned in the table can be used, but the suitability of the systems must be carefully checked with the child restraint system manufacturer concerned and the seller of those seats.

Child restraint system list

Mass groups	Child restraint systems	Category
0 Up to 10 kg (22 lb.) (0 - 9 months)	LEXUS G 0+, BABYSAFE PLUS with SEAT BELT FIXATION, BASE PLATFORM	Semi-universal
0+ Up to 13 kg (28 lb.) (0 - 2 years)	LEXUS G 0+, BABYSAFE PLUS with SEAT BELT FIXATION, BASE PLATFORM	Semi-universal

Child restraint system suitability for various seating positions (with ISOFIX rigid anchors)

Information provided in the table shows your child restraint system suitability for various seating positions.

Mass groups	Size class	Fixture	Vehicle ISOFIX positions
			Outboard rear seat
Carrycot	F	ISO/L1	X
	G	ISO/L2	X
0 Up to 10 kg (22 lb.) (0 - 9 months)	E	ISO/R1	IL
0+ Up to 13 kg (28 lb.) (0 - 2 years)	E	ISO/R1	IL
	D	ISO/R2	IL
	C	ISO/R3	X
I 9 to 18 kg (20 to 39 lb.) (9 months - 4 years)	D	ISO/R2	X
	C	ISO/R3	X
	B	ISO/F2	IUF*, IL*
	B1	ISO/F2X	IUF*, IL*
	A	ISO/F3	IUF*, IL*

Key of letters inserted in the above table:

IUF: Suitable for ISOFIX forward-facing child restraint systems of universal category approved for use in this mass group.

IL: Suitable for child restraint systems shown in the ISOFIX child restraint system list.

When using a "LEXUS MINI" or "LEXUS MIDI", adjust the support leg and ISOFIX connectors as follows:

- ① Lock the ISOFIX connectors where numbers 3, 4 and 5 can be seen.
- ② Lock the support leg where 5th hole can be seen.

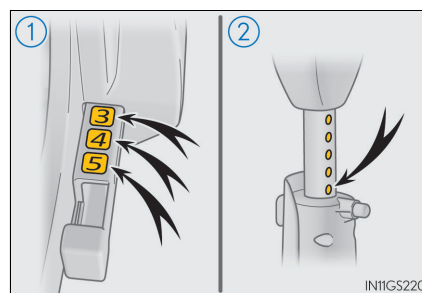

X: ISOFIX position not suitable for ISOFIX child restraint systems in this mass group and/or this size class.

*: If the head restraint interferes with your child restraint system, and the head restraint can be removed, remove the head restraint.

The child restraint systems mentioned in the table may not be available outside of the EU area.

Other child restraint systems which are different from the systems mentioned in the table can be used, but the suitability of the systems must be carefully checked with the child restraint system manufacturer and retailer.

ISOFIX child restraint system list

Mass groups	Size class	Fixture	ISOFIX child restraint systems	Category
0 Up to 10 kg (22 lb.) (0 - 9 months)	E	ISO/R1	LEXUS MINI	Semi-universal
	E	ISO/R1	LEXUS MIDI	Semi-universal
0+ Up to 13 kg (28 lb.) (0 - 2 years)	E	ISO/R1	LEXUS MINI	Semi-universal
	E	ISO/R1	LEXUS MIDI	Semi-universal
	D	ISO/R2	LEXUS MINI	Semi-universal
	D	ISO/R2	LEXUS MIDI	Semi-universal
I 9 to 18 kg (20 to 39 lb.) (9 months - 4 years)	B	ISO/F2	LEXUS MIDI	Semi-universal
	B1	ISO/F2X	LEXUS MIDI	Semi-universal
	A	ISO/F3	LEXUS MIDI	Semi-universal

■ When installing a child restraint system on the front passenger seat

When you have to use a child restraint system on the front passenger seat, adjust the following:

- The seatback to the most upright position
- The seat cushion to the highest position
- The seat cushion to the fully rearward position

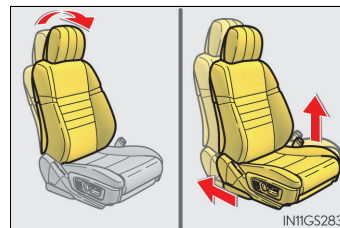

■ Selecting an appropriate child restraint system

- Use a child restraint system appropriate for the child until the child becomes large enough to properly wear the vehicle's seat belt.
- If the child is too large for a child restraint system, sit the child on a rear seat and use the vehicle's seat belt. (→P. 38)

⚠ WARNING

■ Using a child restraint system

The use of a child restraint system not suitable for the vehicle may not properly secure the infant or child. It may result in death or serious injury (in the event of sudden braking or an accident).

 **WARNING****■ Child restraint precautions**

- For effective protection in automobile accidents and sudden stops, a child must be properly restrained, using a seat belt or child restraint system depending on the age and size of the child. Holding a child in your arms is not a substitute for a child restraint system. In an accident, the child can be crushed against the windshield, or between you and the vehicle's interior.
- Lexus strongly urges the use of a proper child restraint system that conforms to the size of the child, installed on the rear seat. According to accident statistics, the child is safer when properly restrained in the rear seat than in the front seat.
- Never use a rear-facing child restraint system on the front passenger seat when the airbag manual on-off switch is on. (→P. 54)
In the event of an accident, the force of the rapid inflation of the front passenger airbag can cause death or serious injury to the child.
- A forward-facing child restraint system may be installed on the front passenger seat only when it is unavoidable. A child restraint system that requires a top strap should not be used in the front passenger seat since there is no top strap anchor for the front passenger seat. Adjust the seatback as upright as possible and always move the seat as far back as possible because the front passenger airbag could inflate with considerable speed and force. Otherwise, the child may be killed or seriously injured.
- Do not allow the child to lean his/her head or any part of his/her body against the door or the area of the seat, front and rear pillars or roof side rails from which the SRS side airbags or SRS curtain shield airbags deploy even if the child is seated in the child restraint system. It is dangerous if the SRS side airbags and curtain shield airbags inflate, and the impact could cause death or serious injury to the child.
- Make sure you have complied with all installation instructions provided by the child restraint manufacturer and that the system is properly secured. If it is not secured properly, it may cause death or serious injury to the child in the event of a sudden stop, sudden swerve or accident.

■ When children are in the vehicle

Do not allow children to play with the seat belt. If the seat belt becomes twisted around a child's neck, it may lead to choking or other serious injuries that could result in death. If this occurs and the buckle cannot be unfastened, scissors should be used to cut the belt.

■ When the child restraint system is not in use

- Keep the child restraint system properly secured on the seat even if it is not in use. Do not store the child restraint system unsecured in the passenger compartment.
- If it is necessary to detach the child restraint system, remove it from the vehicle or store it securely in the trunk. If a head restraint was removed when installing a child restraint system, always install the head restraint before driving. This will prevent it from injuring passengers in the event of a sudden stop, sudden swerve or accident.

Installing child restraints

Follow the child restraint system manufacturer's instructions. Firmly secure child restraints to the seats using a seat belt or ISOFIX rigid anchors. Attach the top strap when installing a child restraint.

Seat belts (An ELR belt requires a locking clip)

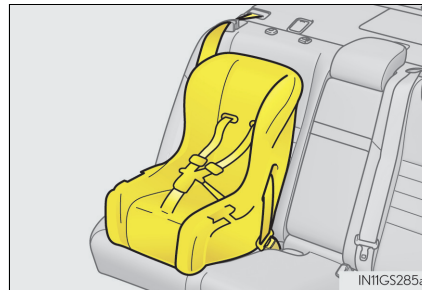

ISOFIX rigid anchors

Lower anchors are provided for the outboard rear seats. (Buttons displaying the location of the anchors are attached to the seats.)

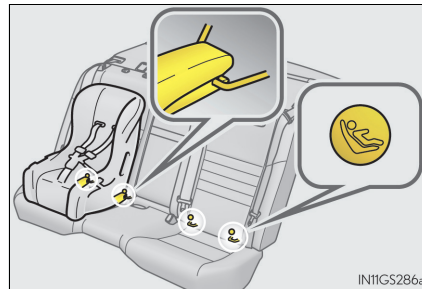

Anchor brackets (for top strap)

Anchor brackets are provided for the outboard rear seats.

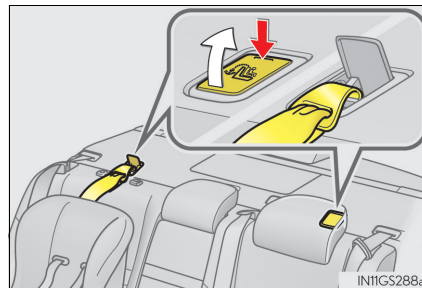

Installing child restraints using a seat belt

■ Rear-facing — Baby seat/child seat

- 1 Place the child restraint system on the rear seat facing the rear of the vehicle.

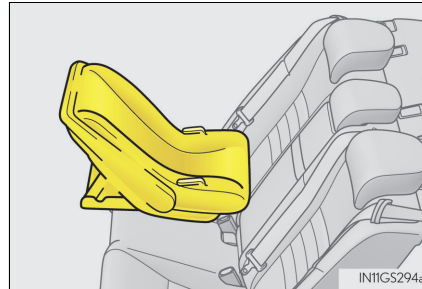

- 2 Run the seat belt through the child restraint system and insert the plate into the buckle. Make sure that the belt is not twisted.

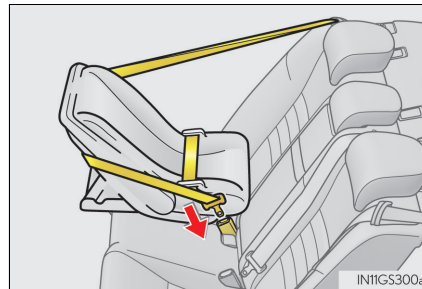

- 3 Install a locking clip near the tab of the lap and shoulder belt by inserting the lap and shoulder webbing through the recesses of the locking clip. Buckle the belt again. If the belt has any slack, release the buckle and reinstall the locking clip.

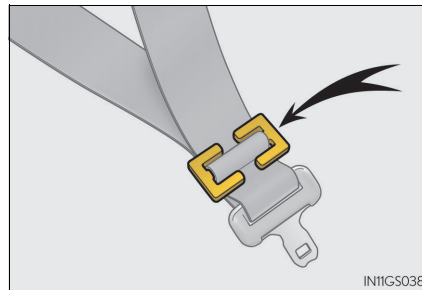

■ Forward-facing — Child seat

- 1 Remove the head restraint if it interferes with your child restraint system.

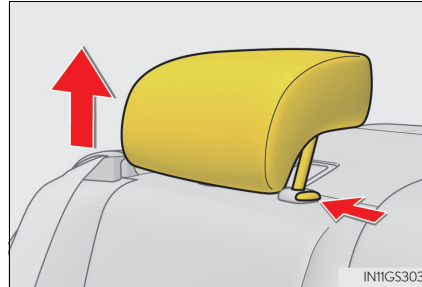

- 2 Place the child restraint system on the seat facing the front of the vehicle.

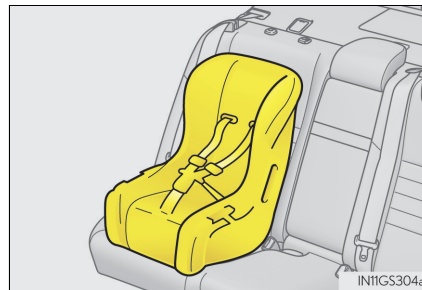

- 3 Run the seat belt through the child restraint system and insert the plate into the buckle. Make sure that the belt is not twisted.

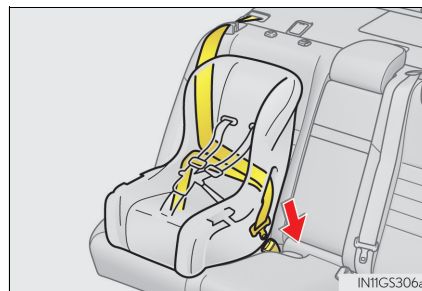

- 4 Install a locking clip near the tab of the lap and shoulder belt by inserting the lap and shoulder webbing through the recesses of the locking clip. Buckle the belt again. If the belt has any slack, release the buckle and reinstall the locking clip.

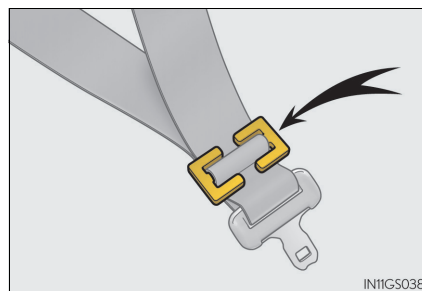

■ Junior seat

- 1 Remove the head restraint if it interferes with your child restraint system.

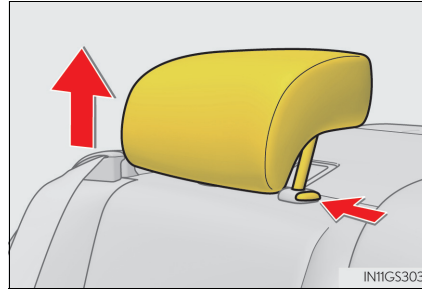

- 2 Place the child restraint system on the seat facing the front of the vehicle.

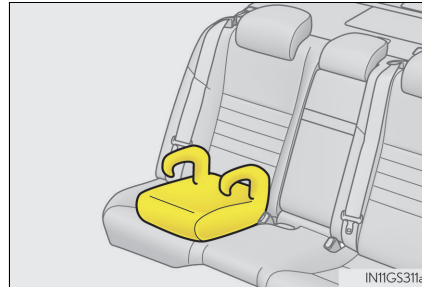

- 3 Sit the child in the child restraint system. Fit the seat belt to the child restraint system according to the manufacturer's instructions and insert the plate into the buckle. Make sure that the belt is not twisted.

Check that the shoulder belt is correctly positioned over the child's shoulder and that the lap belt is as low as possible. (→P. 38)



Removing a child restraint installed with a seat belt

Push the buckle release button and fully retract the seat belt.

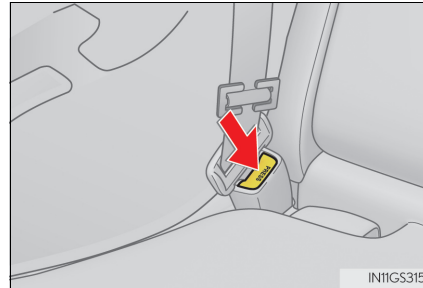

Installation with ISOFIX rigid anchor

- 1 Remove the head restraint if it interferes with your child restraint system.

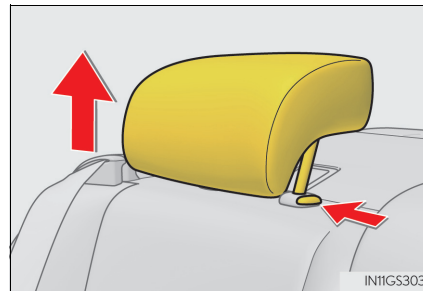

- 2 Widen the gap between the seat cushion and seatback slightly.
- 3 Latch the buckles onto the exclusive fixing bars.

If the child restraint has a top strap, the top strap should be latched onto the anchor bracket.

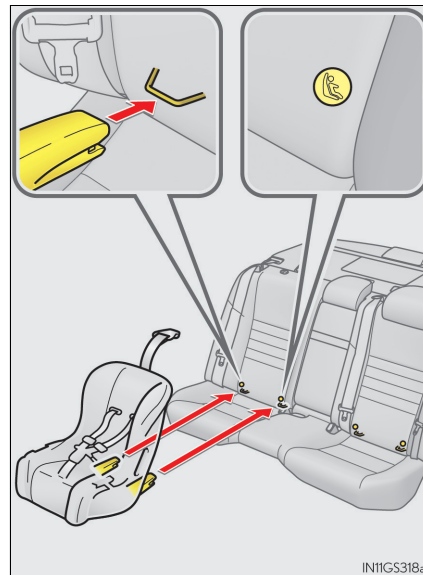

Child restraint systems with a top strap

- 1 Remove the head restraint.

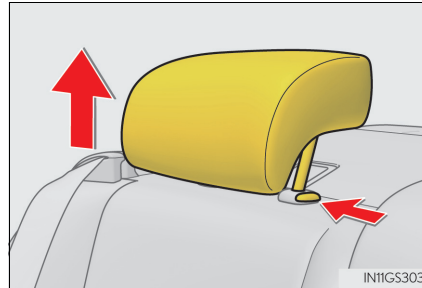

- 2 Secure the child restraint system using the seat belt or ISOFIX rigid anchors.

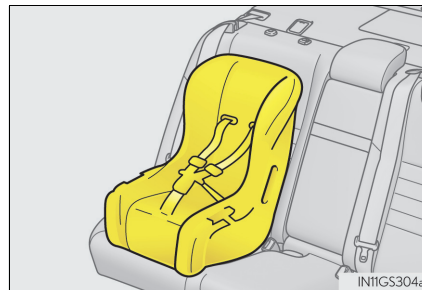

- 3 Open the anchor bracket cover, latch the hook onto the anchor bracket and tighten the top strap. Make sure the top strap is securely latched.

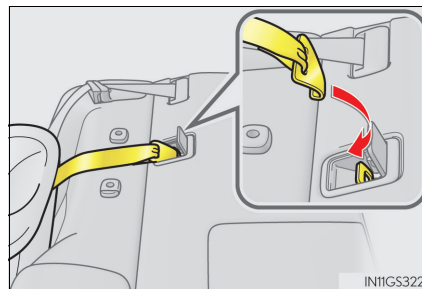

■ When installing a child restraint system

You need a locking clip to install the child restraint system. Follow the instructions provided by the manufacturer of the system. If your child restraint system does not provide a locking clip, you can purchase the following item from any authorized Lexus retailer or Lexus authorized repairer, or any reliable repairer:

Locking clip for child restraint system
(Part No. 73119-22010)

⚠ WARNING**■ When installing a child restraint system**

Follow the directions given in the child restraint system installation manual and fix the child restraint system securely in place.

If the child restraint system is not correctly fixed in place, the child or other passengers may be seriously injured or even killed in the event of sudden braking, sudden swerving or an accident.

- If the driver's seat interferes with the child restraint system and prevents it from being attached correctly, attach the child restraint system to the right-hand rear seat (left-hand drive vehicles) or the left-hand rear seat (right-hand drive vehicles).
- Adjust the front passenger seat so that it does not interfere with the child restraint system.
- Only put a forward-facing child restraint system on the front seat when unavoidable. When installing a forward-facing child restraint system on the front passenger seat, move the seat as far back as possible. Failure to do so may result in death or serious injury if the airbags deploy (inflate).

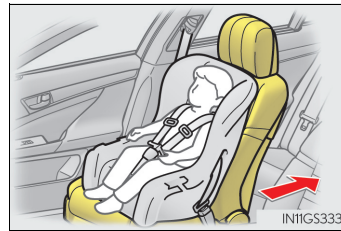
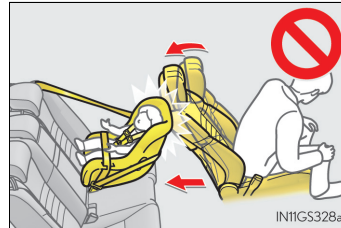

! WARNING

■ When installing a child restraint system

- Never use a rear-facing child restraint system on the front passenger seat when the airbag manual on-off switch is on. (→P. 54)

The force of the rapid inflation of the front passenger airbag can cause death or serious injury to children in the event of an accident.



- There is a label(s) on the passenger side sun visor, indicating it is forbidden to attach a rear-facing child restraint system to the front passenger seat.

Details of the label(s) are shown in the illustration below.

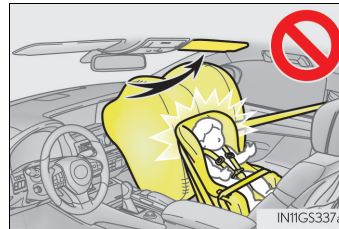

IT1171118a

 **WARNING****■ When installing a child restraint system**

- If child restraint system regulations exist in the country where you reside, please contact any authorized Lexus retailer or Lexus authorized repairer, or any reliable repairer for the child restraint system installation.
- When a junior seat is installed, always ensure that the shoulder belt is positioned across the center of the child's shoulder. The belt should be kept away from the child's neck, but not so that it could fall off the child's shoulder. Failing to do so may result in death or serious injury in the event of sudden braking, sudden swerving or an accident.
- Ensure that the belt and plate are securely locked and the seat belt is not twisted.
- Shake the child restraint system left and right, and forward and backward to ensure that it has been securely installed.
- After securing a child restraint system, never adjust the seat.
- Follow all installation instructions provided by the child restraint system manufacturer.

■ To correctly attach a child restraint system to the anchors

When using the lower anchors, be sure that there are no foreign objects around the anchors and that the seat belt is not caught behind the child restraint system. Make sure the child restraint system is securely attached, or it may cause death or serious injury to the child or other passengers in the event of sudden braking, sudden swerving or an accident.

Exhaust gas precautions

Harmful substance to the human body is included in exhaust gases if inhaled.

WARNING

Exhaust gases include harmful carbon monoxide (CO), which is colorless and odorless. Observe the following precautions.

Failure to do so may cause exhaust gases enter the vehicle and may lead to an accident caused by light-headedness, or may lead to death or a serious health hazard.

■ Important points while driving

- Keep the trunk lid closed.
- If you smell exhaust gases in the vehicle even when the trunk lid is closed, open the windows and have the vehicle inspected at any authorized Lexus retailer or Lexus authorized repairer, or any reliable repairer as soon as possible.

■ When parking

- If the vehicle is in a poorly ventilated area or a closed area, such as a garage, stop the hybrid system.
- Do not leave the vehicle with the hybrid system on for a long time.
If such a situation cannot be avoided, park the vehicle in an open space and ensure that exhaust fumes do not enter the vehicle interior.
- Do not leave the hybrid system operating in an area with snow build-up, or where it is snowing. If snowbanks build up around the vehicle while the hybrid system is operating, exhaust gases may collect and enter the vehicle.

■ Exhaust pipe

The exhaust system needs to be checked periodically. If there is a hole or crack caused by corrosion, damage to a joint or abnormal exhaust noise, be sure to have the vehicle inspected and repaired by any authorized Lexus retailer or Lexus authorized repairer, or any reliable repairer.

Hybrid system features

Your vehicle is a hybrid vehicle. It has characteristics different from conventional vehicles. Be sure you are closely familiar with the characteristics of your vehicle, and operate it with care.

The hybrid system combines the use of a gasoline engine and an electric motor (traction motor) according to driving conditions, improving fuel efficiency and reducing exhaust emissions.

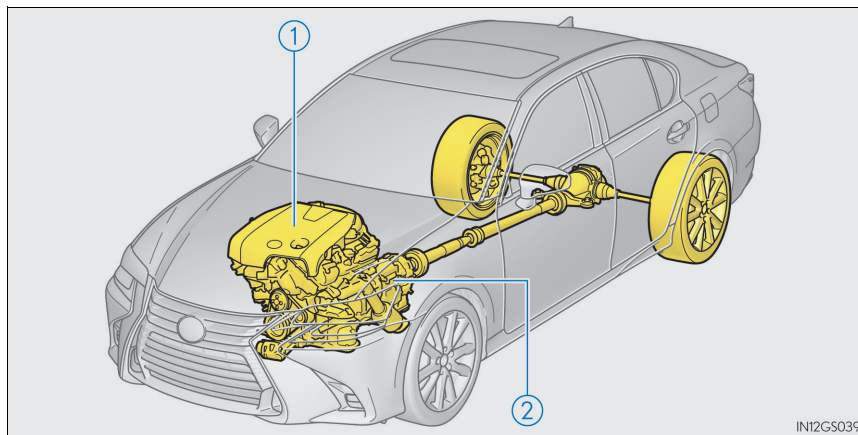

The illustration is an example for explanation and may differ from the actual item.

- ① Gasoline engine
- ② Electric motor (traction motor)

◆ When stopped/during start off

The gasoline engine stops* when the vehicle is stopped. During start off, the electric motor (traction motor) drives the vehicle. At slow speeds or when traveling down a gentle slope, the engine is stopped* and the electric motor (traction motor) is used.

When shift lever is in N, the hybrid battery (traction battery) is not being charged.

*: When the hybrid battery (traction battery) requires charging or the engine is warming up, etc., the gasoline engine will not automatically stop. (→P. 78)

◆ During normal driving

The gasoline engine is predominantly used. The electric motor (traction motor) charges the hybrid battery (traction battery) as necessary.

◆ When accelerating sharply

When the accelerator pedal is depressed heavily, the power of the hybrid battery (traction battery) is added to that of the gasoline engine via the electric motor (traction motor).

◆ When braking (regenerative braking)

The wheel operate the electric motor (traction motor) as a power generator, and the hybrid battery (traction battery) is charged.

■ Regenerative braking

In the following situations, kinetic energy is converted to electric energy and deceleration force can be obtained in conjunction with the recharging of the hybrid battery (traction battery).

- The accelerator pedal is released while driving with the shift lever in D or S.
- The brake pedal is depressed while driving with the shift lever in D or S.

■ EV indicator

The EV indicator comes on when the vehicle is driven using only the electric motor (traction motor) or the gasoline engine is stopped.

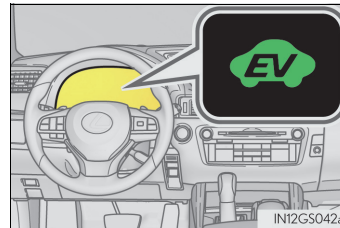

■ Conditions in which the gasoline engine may not stop

The gasoline engine starts and stops automatically. However, it may not stop automatically in the following conditions:

- During gasoline engine warm-up
- During hybrid battery (traction battery) charging
- When the temperature of the hybrid battery (traction battery) is high or low
- When the heater is switched on

■ Charging the hybrid battery (traction battery)

As the gasoline engine charges the hybrid battery (traction battery), the battery does not need to be charged from an outside source. However, if the vehicle is left parked for a long time the hybrid battery (traction battery) will slowly discharge. For this reason, be sure to drive the vehicle at least once every few months for at least 30 minutes or 16 km (10 miles). If the hybrid battery (traction battery) becomes fully discharged and you are unable to start the hybrid system, contact any authorized Lexus retailer or Lexus authorized repairer, or any reliable repairer.

■ Charging the 12-volt battery

→P. 533

■ After the 12-volt battery has discharged or when the terminal has been removed and installed during exchange, etc.

The gasoline engine may not stop even if the vehicle is being driven by the hybrid battery (traction battery). If this continues for a few days, contact any authorized Lexus retailer or Lexus authorized repairer, or any reliable repairer.

■ Sounds and vibrations specific to a hybrid vehicle

There may be no engine sound or vibration even though the vehicle is able to move with the "READY" indicator is illuminated. For safety, apply the parking brake and make sure to shift the shift lever to P when parked.

The following sounds or vibrations may occur when the hybrid system is operating and are not a malfunction:

- Motor sounds may be heard from the engine compartment.
- Sounds may be heard from the hybrid battery (traction battery) behind the rear seats when the hybrid system starts or stops.
- Relay operating sounds such as a snap or soft clank will be emitted from the hybrid battery (traction battery), behind the rear seats, when the hybrid system is started or stopped.
- Sounds from the hybrid system may be heard when the trunk lid is open.
- Sounds may be heard from the transmission when the gasoline engine starts or stops, when driving at low speeds, or during idling.
- Engine sounds may be heard when accelerating sharply.
- Sounds may be heard due to regenerative braking when the brake pedal is depressed or as the accelerator pedal is released.
- Vibration may be felt when the gasoline engine starts or stops.
- Cooling fan sounds may be heard from the air intake vents on the both sides of the rear seatback.

■ Maintenance, repair, recycling, and disposal

Contact any authorized Lexus retailer or Lexus authorized repairer, or any reliable repairer regarding maintenance, repair, recycling and disposal. Do not dispose of the vehicle yourself.

■ Customization

Settings (e.g. on/off operation of the EV indicator) can be changed.
(Customizable features: →P. 561)

Hybrid system precautions

Take care when handling the hybrid system, as it is a high voltage system (about 650 V at maximum) as well as contains parts that become extremely hot when the hybrid system is operating. Obey the warning labels attached to the vehicle.

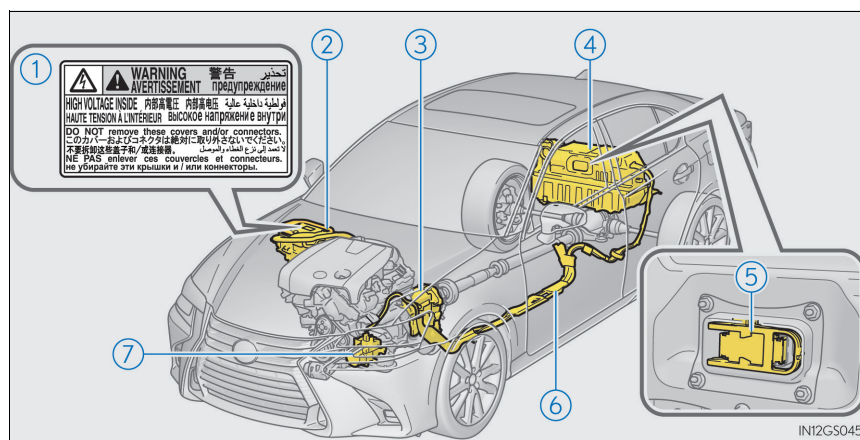

The illustration is an example for explanation and may differ from the actual item.

- | | |
|-------------------------------------|--------------------------------|
| ① Warning label | ⑤ Service plug |
| ② Power control unit | ⑥ High voltage cables (orange) |
| ③ Electric motor (traction motor) | ⑦ Air conditioning compressor |
| ④ Hybrid battery (traction battery) | |

Hybrid battery (traction battery) air intake vents

There are air intake vents on the both sides of the rear seatback for the purpose of cooling the hybrid battery (traction battery). If the vents become blocked, the hybrid battery may over-heat, leading to a reduction in hybrid battery output.

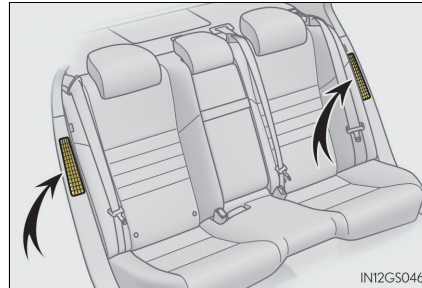

Emergency shut off system

When a certain level of impact is detected by the impact sensor, the emergency shut off system blocks the high voltage current and stops the fuel pump to minimize the risk of electrocution and fuel leakage. If the emergency shut off system activates, your vehicle will not restart. To restart the hybrid system, contact any authorized Lexus retailer or Lexus authorized repairer, or any reliable repairer.

Hybrid warning message

A message is automatically displayed when a malfunction occurs in the hybrid system or an improper operation is attempted.

If a warning message is shown on the multi-information display, read the message and follow the instructions. (→P. 466)

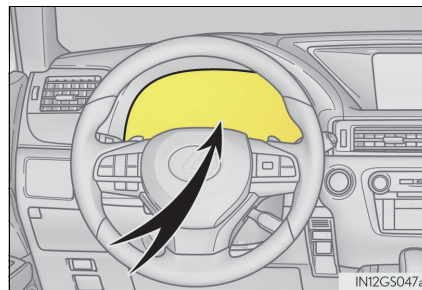

■ **If a warning light comes on, a warning message is displayed, or the 12-volt battery is disconnected**

The hybrid system may not start. In this case, try to start the system again. If the "READY" indicator does not come on, contact any authorized Lexus retailer or Lexus authorized repairer, or any reliable repairer.

■ **Running out of fuel**

When the vehicle has run out of fuel and the hybrid system cannot be started, refuel the vehicle with at least enough gasoline to make the low fuel level warning light (→P. 462) go off. If there is only a small amount of fuel, the hybrid system may not be able to start. (The standard amount of fuel is about 9.9 L [2.6 gal., 2.2 Imp.gal.], when the vehicle is on a level surface. This value may vary when the vehicle is on a slope. Add extra fuel when the vehicle is inclined.)

■ **Electromagnetic waves**

- High voltage parts and cables on hybrid vehicles incorporate electromagnetic shielding, and therefore emit approximately the same amount of electromagnetic waves as conventional gasoline powered vehicles or home electronic appliances.
- Your vehicle may cause sound interference in some third party-produced radio parts.

■ **Hybrid battery (traction battery)**

The hybrid battery (traction battery) has a limited service life. The lifespan of the hybrid battery (traction battery) can change in accordance with driving style and driving conditions.

■ **Declaration of conformity**

This model conforms to hydrogen emissions according to regulation ECE100 (Battery electric vehicle safety).

⚠ WARNING

■ **High voltage precautions**

This vehicle has high voltage DC and AC systems as well as a 12-volt system. DC and AC high voltage is very dangerous and can cause severe burns and electric shock that may result in death or serious injury.

- Never touch, disassemble, remove or replace the high voltage parts, cables or their connectors.
- The hybrid system will become hot after starting as the system uses high voltage. Be careful of both the high voltage and the high temperature, and always obey the warning labels attached to the vehicle.
- Never try to open the service plug access hole located behind the rear seats. The service plug is used only when the vehicle is serviced and is subject to high voltage.

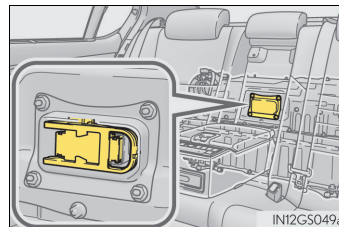

 **WARNING****■ Road accident cautions**

Observe the following precautions to reduce the risk of death or serious injury:

- Pull your vehicle off the road, apply the parking brake, shift the shift lever to P, and turn the hybrid system off.
- Do not touch the high voltage parts, cables and connectors.
- If electric wires are exposed inside or outside your vehicle, an electric shock may occur. Never touch exposed electric wires.
- If a fluid leak occurs, do not touch the fluid as it may be strong alkaline electrolyte from the hybrid battery (traction battery). If it comes into contact with your skin or eyes, wash it off immediately with a large amount of water or, if possible, boric acid solution. Seek immediate medical attention.
- If a fire occurs in the hybrid vehicle, leave the vehicle as soon as possible. Never use a fire extinguisher that is not meant for electric fires. Using even a small amount of water may be dangerous.
- If your vehicle needs to be towed, do so with rear wheels raised. If the wheels connected to the electric motor (traction motor) are on the ground when towing, the motor may continue to generate electricity. This may cause a fire. (→P. 454)
- Carefully inspect the ground under the vehicle. If you find that liquid has leaked onto the ground, the fuel system may have been damaged. Leave the vehicle as soon as possible.

 **WARNING****■ Hybrid battery (traction battery)**

- Never resell, hand over or modify the hybrid battery. To prevent accidents, hybrid batteries that have been removed from a disposed vehicle are collected through any authorized Lexus retailer or Lexus authorized repairer, or any reliable repairer. Do not dispose of the battery yourself.

Unless the battery is properly collected, the following may occur, resulting in death or serious injury:

- The hybrid battery may be illegally disposed of or dumped, and it is hazardous to the environment or someone may touch a high voltage part, resulting in an electric shock.
- The hybrid battery is intended to be used exclusively with your hybrid vehicle. If the hybrid battery is used outside of your vehicle or modified in any way, accidents such as electric shock, heat generation, smoke generation, an explosion and electrolyte leakage may occur.

When reselling or handing over your vehicle, the possibility of an accident is extremely high because the person receiving the vehicle may not be aware of these dangers.

- If your vehicle is disposed of without the hybrid battery having been removed, there is a danger of serious electric shock if high voltage parts, cables and their connectors are touched. In the event that your vehicle must be disposed of, the hybrid battery must be disposed of by any authorized Lexus retailer or Lexus authorized repairer, or any reliable repairer. If the hybrid battery is not disposed of properly, it may cause electric shock that can result in death or serious injury.

 **NOTICE****■ Hybrid battery (traction battery) air intake vents**

- Do not place objects that will block the air intake vents. The hybrid battery (traction battery) may overheat and be damaged.
- Clean the air intake vents regularly to prevent the hybrid battery (traction battery) from overheating.
- Do not get water or foreign materials in the air intake vents as this may cause a short circuit and damage the hybrid battery (traction battery).
- Do not carry large amounts of water such as water cooler bottles in the vehicle. If water spills onto the hybrid battery (traction battery), the battery may be damaged. Have the vehicle inspected by any authorized Lexus retailer or Lexus authorized repairer, or any reliable repairer.

Immobilizer system

The vehicle's keys have built-in transponder chips that prevent the hybrid system from starting if a key has not been previously registered in the vehicle's on-board computer.

Never leave the keys inside the vehicle when you leave the vehicle.

This system is designed to help prevent vehicle theft but does not guarantee absolute security against all vehicle thefts.

The indicator light flashes after the power switch has been turned off to indicate that the system is operating.

The indicator light stops flashing after the power switch has been turned to ACCESSORY or ON mode to indicate that the system has been canceled.

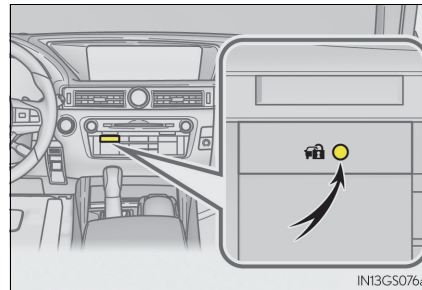

■ System maintenance

The vehicle has a maintenance-free type immobilizer system.

■ Conditions that may cause the system to malfunction

- If the grip portion of the key is in contact with a metallic object
- If the key is in close proximity to or touching a key to the security system (key with a built-in transponder chip) of another vehicle

■ Certifications for the immobilizer system

TOYOTA**TOYOTA MOTOR CORPORATION**

1, TOYOTA-CHO, TOYOTA, AICHI, 471-8571, JAPAN TEL: +81-565-28-2121

R&TTE Declaration of Conformity

We,

Manufacturer's Name: TOYOTA MOTOR CORPORATION

Manufacturer's Address: 1, Toyota -cho, Toyota, Aichi, 471-8572, Japan

hereby declare under our sole responsibility that the product:

Product Name: Immobilizer

Product Model: TMIMB-3

to which this declaration relates is in conformity with the essential requirements and other relevant requirements of the R&TTE Directive (1999/5/EC). The product is compliant with the following standards and/or other normative documents:

-Health & safety requirements:	EN 60950-1
-EMC requirements	EN 301 489-01 & EN 301 489-03
-Effective uses of radio spectrum:	EN 300 330-2

Supplementary information:

* CE mark	
* Member states intended for use	EU and EFTA

Date: February 25, 2013

Signature: 

Tetsuya Matsuo

<p>Hereby, TOYOTA MOTOR CORPORATION, declares that this TMIMB-3 is in compliance with the essential requirements and other relevant provisions of Directive 1999/5/EC.</p>
<p>TOYOTA MOTOR CORPORATION vakuuttaa täten että TMIMB-3 tyyppinen laite on direktiivin 1999/5/EY oleellisten vaatimusten ja sitä koskevien direktiivin muiden ehtojen mukainen.</p>
<p>Hierbij verklaart TOYOTA MOTOR CORPORATION dat het toestel TMIMB-3 in overeenstemming is met de essentiële eisen en de andere relevante bepalingen van richtlijn 1999/5/EG.</p>
<p>Par la présente TOYOTA MOTOR CORPORATION déclare que l'appareil TMIMB-3 est conforme aux exigences essentielles et aux autres dispositions pertinentes de la directive 1999/5/CE.</p>
<p>Härmed intygar TOYOTA MOTOR CORPORATION att denna TMIMB-3 står i överensstämmelse med de väsentliga egenskapskrav och övriga relevanta bestämmelser som framgår av direktiv 1999/5/EG.</p>
<p>Undertegnede TOYOTA MOTOR CORPORATION erklærer herved, at følgende udstyr TMIMB-3 overholder de væsentlige krav og øvrige relevante krav i direktiv 1999/5/EF.</p>
<p>Hiermit erklärt TOYOTA MOTOR CORPORATION, dass sich das Gerät TMIMB-3 in Übereinstimmung mit den grundlegenden Anforderungen und den übrigen einschlägigen Bestimmungen der Richtlinie 1999/5/EG befindet.</p>
<p>ΜΕ ΤΗΝ ΠΑΡΟΥΣΑ ΤΟΥΤΑ ΜΟΤΟΡ ΚΟΡΠΟΡΑΤΙΟΝ ΔΗΛΩΝΕΙ ΟΤΙ ΤΜΙΜΒ-3 ΣΥΜΜΟΡΦΩΝΕΤΑΙ ΠΡΟΣ ΤΙΣ ΟΥΣΙΩΔΕΙΣ ΑΠΑΙΤΗΣΕΙΣ ΚΑΙ ΤΙΣ ΛΟΙΠΕΣ ΣΧΕΤΙΚΕΣ ΔΙΑΤΑΞΕΙΣ ΤΗΣ ΟΔΗΓΙΑΣ 1999/5/ΕΚ.</p>
<p>Con la presente TOYOTA MOTOR CORPORATION dichiara che questo TMIMB-3 è conforme ai requisiti essenziali ed alle altre disposizioni pertinenti stabilite dalla direttiva 1999/5/CE.</p>
<p>Por medio de la presente TOYOTA MOTOR CORPORATION declara que el TMIMB-3 cumple con los requisitos esenciales y cualesquiera otras disposiciones aplicables o exigibles de la Directiva 1999/5/CE.</p>
<p>TOYOTA MOTOR CORPORATION declara que este TMIMB-3 está conforme com os requisitos essenciais e outras disposições da Directiva 1999/5/CE.</p>
<p>Hawnhekk, TOYOTA MOTOR CORPORATION, jiddikjara li dan TMIMB-3 jikkonforma mal-htigijiet essenzjali u ma provvedimenti oħrajn relevanti li hemm fid-Dirrettiva 1999/5/EC.</p>
<p>Käesolevaga kinnitab TOYOTA MOTOR CORPORATION seadme TMIMB-3 vastavust direktiivi 1999/5/EÜ põhinõuetele ja nimetatud direktiivist tulenevatele teistele asjakohastele sätetele.</p>
<p>Alulirott, TOYOTA MOTOR CORPORATION nyilatkozom, hogy a TMIMB-3 megfelel a vonatkozó alapvető követelményeknek és az 1999/5/EC irányelv egyéb előírásainak.</p>

TOYOTA MOTOR CORPORATION tímto vyhlasuje, že TMIMB-3 spĺňa základné požiadavky a všetky príslušné ustanovenia Smernice 1999/5/ES.
TOYOTA MOTOR CORPORATION tímto prohlašuje, že tento TMIMB-3 je ve shodě se základními požadavky a dalšími příslušnými ustanoveními směrnice 1999/5/ES.
TOYOTA MOTOR CORPORATION izjavlja, da je ta TMIMB-3 v skladu z bistvenimi zahtevami in ostalimi relevantnimi določili direktive 1999/5/ES.
Šiuo TOYOTA MOTOR CORPORATION deklaruoja, kad šis TMIMB-3 atitinka esminius reikalavimus ir kitas 1999/5/EB Direktyvos nuostatas.
Ar šo TOYOTA MOTOR CORPORATION deklarē, ka TMIMB-3 atbilst Direktīvas 1999/5/EK būtiskajām prasībām un citiem ar to saistītajiem noteikumiem.
Niniejszym TOYOTA MOTOR CORPORATION oświadcza, że TMIMB-3 jest zgodny z zasadniczymi wymogami oraz pozostałymi stosownymi postanowieniami Dyrektywy 1999/5/EC.
Hér með lýsir TOYOTA MOTOR CORPORATION yfir því að TMIMB-3 er í samræmi við grunnkröfur og aðrar kröfur, sem gerðar eru í tilskipun 1999/5/EC.
TOYOTA MOTOR CORPORATION erklærer herved at utstyret TMIMB-3 er i samsvar med de grunnleggende krav og øvrige relevante krav i direktiv 1999/5/EF.
С настоящего, TOYOTA MOTOR CORPORATION, декларира, че TMIMB-3 е в съответствие със съществените изисквания и другите приложими разпоредби на Директива 1999/5/EC.
Prin prezenta, TOYOTA MOTOR CORPORATION, declară că aparatul TMIMB-3 este in conformitate cu cerințele esențiale și cu alte prevederi pertinente ale Directivei 1999/5/CE.
Ovim, TOYOTA MOTOR CORPORATION, izjavljuje da ovaj TMIMB-3 je usklađen sa bitnim zahtjevima i drugim relevantnim odredbama Direktive 1999/5/EC.
Nepernjat kesaj, TOYOTA MOTOR CORPORATION, deklaroi qe ky TMIMB-3 eshte ne pajtim me kerkesat thelbesore dhe dispozitat e tjera perkatese te Direktives 1999/5/EC.
Ovim TOYOTA MOTOR CORPORATION, izjavljuje da je TMIMB-3 u skladu s bitnim zahtjevima i drugim relevantnim odredbama Direktive 1999/5/EC i Pravilnika o RiTT opremi (NN 25/2012).
Ovim, TOYOTA MOTOR CORPORATION, deklarirše da je TMIMB-3 u skladu sa osnovnim zahtevima i ostalim relevantnim odredbama Direktive 1999/5/EC.
İşbu belge ile TOYOTA MOTOR CORPORATION, bu TMIMB-3 ürününün 1999/5/EC Yönetmeliği'nin temel gerekliliklerine ve diğer ilgili hükümlerine uygun olduğunu beyan eder.

 NOTICE**■ To ensure the system operates correctly**

Do not modify or remove the system. If modified or removed, the proper operation of the system cannot be guaranteed.

1

For safety and security

Double locking system

Unauthorized access to the vehicle is prevented by disabling the door unlocking function from both the interior and exterior of the vehicle.

Vehicles employing this system have labels on the window glass of both front doors.

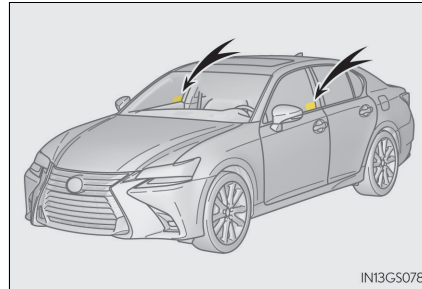

Setting the double locking system

Turn the power switch off, have all the passengers exit the vehicle and ensure that all the doors are closed.

Using the entry function:

Touch the sensor area on the outside door handle twice within 5 seconds.

Using the wireless remote control:

Press  twice within 5 seconds.

Canceling the double locking system

Using the entry function: Hold the outside door handle.

Using the wireless remote control: Press  .

WARNING

■ Double locking system precaution

Never activate the double locking system when there are people in the vehicle because all the doors cannot be opened from inside the vehicle.

Alarm*

The alarm

The alarm uses light and sound to give an alert when an intrusion is detected.

The alarm is triggered in the following situations when the alarm is set:

- A locked door is unlocked or opened in any way other than using the entry function or wireless remote control. (The door will lock again automatically.)
- A trunk is opened in any way other than using the entry function, wireless remote control or mechanical key.
- The hood is opened.
- The tilt sensor detects a change of vehicle inclination. (if equipped)

Setting the alarm system

Close the doors, trunk and hood, and lock all the doors using the entry function or wireless remote control. The system will be set automatically after 30 seconds.

The indicator light changes from being on to flashing when the system is set.

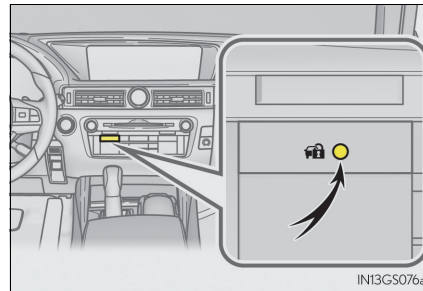

*: If equipped

Deactivating or stopping the alarm

Do one of the following to deactivate or stop the alarm:

- Unlock the doors or open the trunk using the entry function or wireless remote control.
- Turn the power switch to ACCESSORY or ON mode, or start the hybrid system. (The alarm will be deactivated or stopped after a few seconds.)

■ System maintenance

The vehicle has a maintenance-free type alarm system.

■ Items to check before locking the vehicle

To prevent unexpected triggering of the alarm and vehicle theft, make sure of the following:

- Nobody is in the vehicle.
- The windows and moon roof (if equipped) are closed before the alarm is set.
- No valuables or other personal items are left in the vehicle.

■ Triggering of the alarm

The alarm may be triggered in the following situations:
(Stopping the alarm deactivates the alarm system.)

- The doors are unlocked using the mechanical key, or the trunk is opened using the mechanical key.

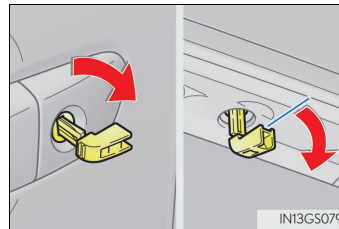

- A person inside the vehicle opens a door, the trunk or hood, or unlocks the vehicle using an inside lock button.



- The 12-volt battery is recharged or replaced when the vehicle is locked. (→P. 533)

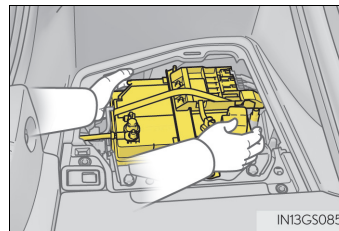

■ Alarm-operated door lock

In the following cases, the door may automatically lock:

- When a person remaining in the vehicle unlocks the door and the alarm is activated.
- While the alarm is activated, a person remaining in the vehicle unlocks the door.
- When recharging or replacing the 12-volt battery.

■ Customization

The alarm can be set to deactivate when the mechanical key is used to unlock.
(Customizable features: →P. 561)

⚠ NOTICE

■ To ensure the system operates correctly

Do not modify or remove the system. If modified or removed, the proper operation of the system cannot be guaranteed.

Intrusion sensor (if equipped) and tilt sensor (if equipped)

- The intrusion sensor detects intruders or movement in the vehicle.
- The tilt sensor detects changes in vehicle inclination, such as when the vehicle is towed away.

This system is designed to deter and prevent vehicle theft but does not guarantee absolute security against all intrusions.

■ Setting the intrusion sensor and tilt sensor

The intrusion sensor and tilt sensor will be set automatically when the alarm is set. (→P. 91)

■ Canceling the intrusion sensor and tilt sensor

If you are leaving pets or other moving things inside the vehicle, make sure to stop the intrusion sensor and tilt sensor before setting the alarm, as they will respond to movement inside the vehicle.

- 1 Turn the power switch off.
- 2 Press the intrusion sensor and tilt sensor cancel switch.

A message will be shown on the multi-information display in the instrument cluster.

Press the switch again to re-enable the intrusion sensor and tilt sensor.

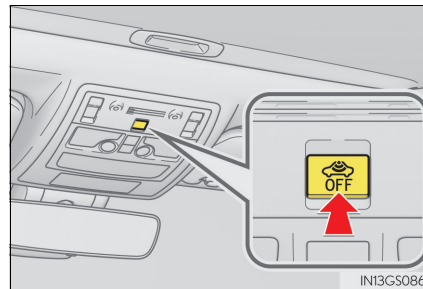

■ Canceling and automatic re-enabling of the intrusion sensor and tilt sensor

- The alarm will still be set even when the intrusion sensor and tilt sensor are canceled.
- After the intrusion sensor and tilt sensor are canceled, pressing the power switch or unlocking the doors using the entry function, wireless remote control or mechanical key will re-enable the intrusion sensor and tilt sensor.
- The intrusion sensor and tilt sensor will automatically be re-enabled when the alarm system is deactivated.

■ Intrusion sensor detection considerations (if equipped)

The sensor may trigger the alarm in the following situations:

- A window or the moon roof (if equipped) is open.
In this case, the sensor may detect the following:
 - Wind or the movement of objects such as leaves and insects inside the vehicle
 - Ultrasonic waves emitted from devices such as the intrusion sensors of other vehicles
 - The movement of people outside the vehicle
- Unstable items, such as dangling accessories or clothes hanging on the coat hooks, are in the vehicle.

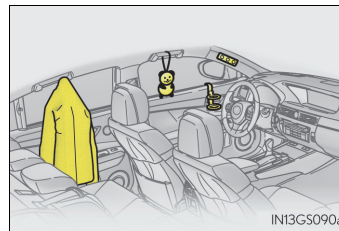
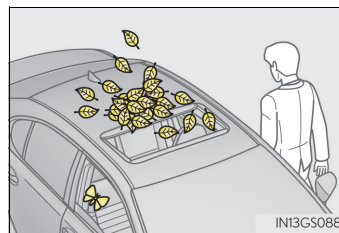

- Places with extreme vibrations or noises, or situations in which the vehicle is subject to repeated impacts or vibrations:
 - When parked in a parking garage
 - When the vehicle is transported by a ferry, trailer, train, etc.
 - When ice adhering to the vehicle is removed
 - When the vehicle is in an automatic or high-pressure car wash
 - When in a hail or lightning storm

■ Tilt sensor detection considerations (if equipped)

The sensor may trigger the alarm in the following situations:

- The vehicle is transported by a ferry, trailer, train, etc.
- The vehicle is parked in a parking garage.
- The vehicle is inside a car wash that moves the vehicle.
- Any of the tires loses air pressure.
- The vehicle is jacked up.
- An earthquake occurs or the road caves in.

⚠ NOTICE**■ To ensure the intrusion sensor function correctly**

- To ensure that the sensors operate properly, do not touch or cover them.

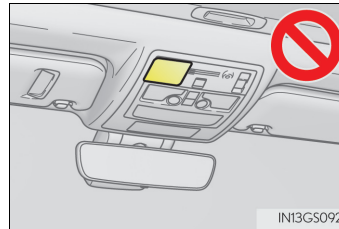

- Do not spray air fresheners or other products directly into the sensor holes.

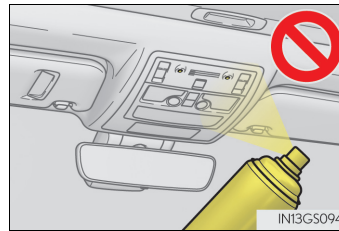

- Installing accessories other than genuine Lexus parts or leaving objects between the driver's seat and front passenger's seat may reduce the detection performance.

Instrument cluster

2

2. Instrument cluster

Warning lights and indicators	98
Gauges and meters	104
Multi-information display	111
Head-up display	119
Energy monitor/ consumption screen	126

Warning lights and indicators

The warning lights and indicators on the instrument cluster, center panel and outside rear view mirrors inform the driver of the status of the vehicle's various systems.

For the purpose of explanation, the following illustration displays all warning lights and indicators illuminated.

- ▶ Except F SPORT models



- ▶ F SPORT models



The units used on the speedometer may differ depending on the target region.

Warning lights





















Warning lights inform the driver of malfunctions in the indicated vehicle's systems.

^{*1} 	Brake system warning light (→P. 460)	^{*2,3}  (If equipped)	"AFS OFF" indicator (→P. 462)
^{*2,4} 	Charging system warning light (→P. 460)	^{*1,3} 	Brake hold operated indicator (→P. 462)
^{*2} 	Malfunction indicator lamp (→P. 460)	^{*3} 	Parking brake indicator (→P. 462)
^{*2} 	SRS warning light (→P. 460)	^{*1} 	Brake system warning light (→P. 462)
^{*1} 	ABS warning light (→P. 461)		Low fuel level warning light (→P. 462)
^{*2} 	Electric power steering system warning light (→P. 461)		Seat belt reminder light (→P. 462)
^{*2,3}  (If equipped)	PCS (Pre-Crash Safety system) warning light (→P. 461)	^{*2} 	Master warning light (→P. 462)
^{*1} 	Slip indicator (→P. 461)	^{*2}  (If equipped)	Tire pressure warning light (→P. 463)
 (If equipped)	LKA warning light (→P. 463)		

- *1: These lights turn on when the power switch is turned to ON mode to indicate that a system check is being performed. They will turn off after the "READY" indicator turns on. There may be a malfunction in a system if a light does not come on, or turn off. Have the vehicle inspected by any authorized Lexus retailer or Lexus authorized repairer, or any reliable repairer.
- *2: These lights turn on when the power switch is turned to ON mode to indicate that a system check is being performed. They will turn off after the hybrid system is on, or after a few seconds. There may be a malfunction in a system if a light does not come on, or turn off. Have the vehicle inspected by any authorized Lexus retailer or Lexus authorized repairer, or any reliable repairer.
- *3: The light flashes to indicate a malfunction.
- *4: F SPORT models





Indicators

The indicators inform the driver of the operating state of the vehicle's various systems.

	Turn signal indicator (→P. 231)		Rear fog light indicator (→P. 250)
	Tail light indicator (→P. 237)		Cruise control indicator (→P. 304, 308)
	Headlight high beam indicator (→P. 238)		Dynamic radar cruise control indicator (→P. 296)
	Automatic High Beam indicator (→P. 246)/ Adaptive High-beam System indicator (→P. 242)	(If equipped)	
	Front fog light indicator (→P. 250)		Cruise control "SET" indicator (→P. 296, 308)
	Lexus parking assist-sensor indicator (If equipped)		LKA indicator (→P. 286)
	"AFS OFF" indicator (→P. 239)	(If equipped)	
	Slip indicator (→P. 326)		Brake hold operated indicator (→P. 235)
	VSC OFF indicator (→P. 327)		"PASSENGER AIR BAG" indicator (→P. 54)
	PCS (Pre-Crash Safety system) warning light (→P. 273)		Low outside temperature indicator (→P. 104)
			"READY" indicator (→P. 217)
			EV indicator (→P. 78)

2







Instrument cluster

<p>*8,9  (If equipped)</p>	<p>BSM (Blind Spot Monitor) outside rear view mirror indicators (→P. 314)</p>	<p> Parking brake indicator (→P. 232)</p>
<p>*2  (If equipped)</p>	<p>Brake hold standby indicator (→P. 235)</p>	<p> (If equipped)</p> <p>“BSM” (Blind Spot Monitor) indicator (→P. 314)</p>







● Drive mode indicators



<p> (If equipped)</p>	<p>EV drive mode indicator (→P. 222)</p>
---	--

► Except F SPORT models

<p> (If equipped)</p>	<p>Eco drive mode indicator (→P. 311)</p>	<p> (If equipped)</p>	<p>“SPORT” indicator (→P. 311)</p>
<p> (If equipped)</p>	<p>“SPORT S” indicator (→P. 311)</p>	<p> (If equipped)</p>	<p>“SPORT S+” indicator (→P. 311)</p>
<p> (If equipped)</p>	<p>“Customize” indicator (→P. 311)</p>	<p> (If equipped)</p>	<p>Snow mode indicator (→P. 225)</p>

► F SPORT models

<p> (If equipped)</p>	<p>Eco drive mode indicator (→P. 311)</p>	<p> (If equipped)</p>	<p>“SPORT” indicator (→P. 311)</p>
<p> (If equipped)</p>	<p>“SPORT S” indicator (→P. 311)</p>	<p> (If equipped)</p>	<p>“SPORT S+” indicator (→P. 311)</p>
<p> (If equipped)</p>	<p>“CUSTOMIZE” indicator (→P. 311)</p>	<p> (If equipped)</p>	<p>Snow mode indicator (→P. 225)</p>

- *1: Refer to "NAVIGATION AND MULTIMEDIA SYSTEM OWNER'S MANUAL"
- *2: These lights turn on when the power switch is turned to ON mode to indicate that a system check is being performed. They will turn off after the "READY" indicator turns on. There may be a malfunction in a system if a light does not come on, or turn off. Have the vehicle inspected by any authorized Lexus retailer or Lexus authorized repairer, or any reliable repairer.
- *3: These lights turn on when the power switch is turned to ON mode to indicate that a system check is being performed. They will turn off after the hybrid system is on, or after a few seconds. There may be a malfunction in a system if the lights do not come on, or turn off. Have the vehicle inspected by any authorized Lexus retailer or Lexus authorized repairer, or any reliable repairer.
- *4: This light illuminates on the Center panel.
- *5: The light flashes to indicate that the system is operating.
- *6: When the outside temperature is approximately 3°C (37°F) or lower, the indicator will flash for approximately 10 seconds, then stay on.
- *7: The light turns on when the system is turned off.
- *8: In order to confirm operation, the BSM outside rear view mirror indicators illuminate in the following situations:
- When the power switch is in ON mode, the BSM function is enabled on  of the multi-information display.
 - When the BSM function is enabled on  of the multi-information display, the power switch is turned to ON mode.
- If the system is functioning correctly, the BSM outside rear view mirror indicators will turn off after a few seconds.
If the BSM outside rear view mirror indicators do not illuminate or do not turn off, there may be a malfunction with the system.
If this occurs, have the vehicle inspected by any authorized Lexus retailer or Lexus authorized repairer, or any reliable repairer.
- *9: This light illuminates on the outside rear view mirrors.

 **WARNING**

■ If a safety system warning light does not come on

Should a safety system light such as the ABS and SRS warning light not come on when you start the hybrid system, this could mean that these systems are not available to help protect you in an accident, which could result in death or serious injury. Have the vehicle inspected by any authorized Lexus retailer or Lexus authorized repairer, or any reliable repairer immediately if this occurs.

Gauges and meters

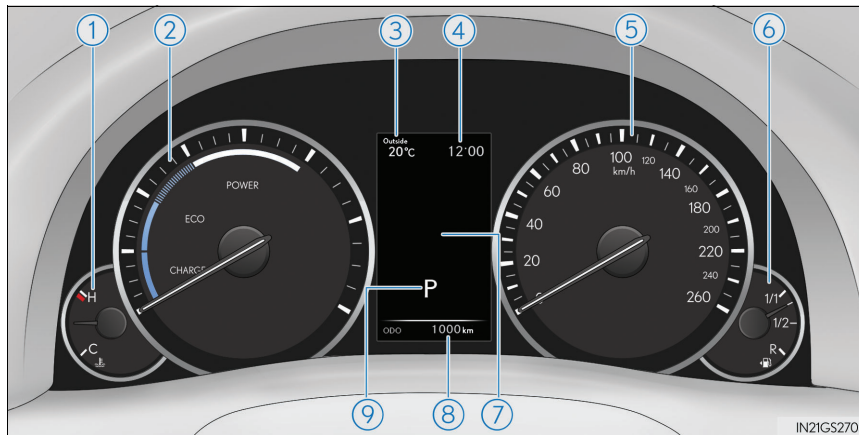

► Except F SPORT models

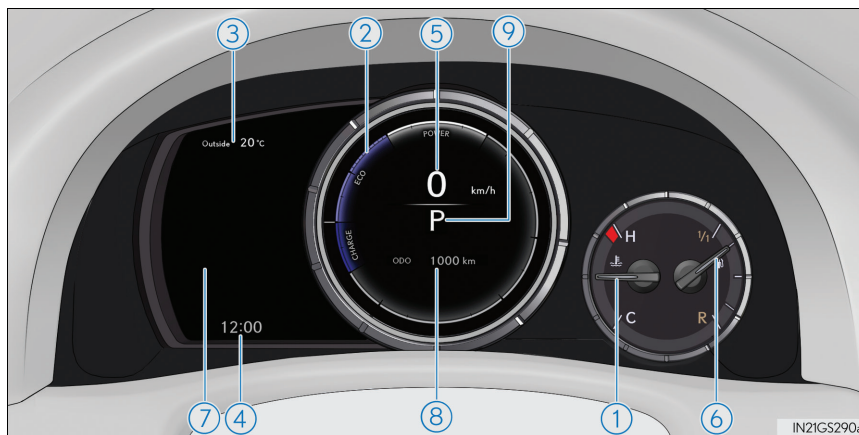

► F SPORT models



The units used on the speedometer may differ depending on the target region.

- ① Engine coolant temperature gauge
Displays the engine coolant temperature
- ② Tachometer/Hybrid System Indicator
Tachometer:
Displays the engine speed in revolutions per minute.
Hybrid System Indicator:
Displays hybrid system output or regeneration level (→P. 108)
- ③ Outside temperature
Displays the outside temperature within the range of -40°C (-40°F) to 50°C (122°F). Low outside temperature indicator comes on when the ambient temperature is 3°C (37°F) or lower.
- ④ Clock
Time displayed is linked to the analog clock on the instrument panel. (→P. 378)
- ⑤ Speedometer
Displays the vehicle speed
- ⑥ Fuel gauge
Displays the quantity of fuel remaining in the tank
- ⑦ Multi-information display
Presents the driver with a variety of driving-related data (→P. 111)
Displays warning messages in case of a malfunction (→P. 466)
- ⑧ Odometer, trip meter, maintenance required information and speed warning display
Odometer:
Displays the total distance the vehicle has been driven
Trip meter:
Displays the distance the vehicle has been driven since the meter was last reset. Trip meters "A" and "B" can be used to record and display different distances independently.
Maintenance required information:
 - Displays the maintenance required information when the power switch is in ON mode.
 - It can be reset from  of the multi-information display. (→P. 111)
 Speed warning:
Displays a warning when the speed set in  of the multi-information display is exceeded. (→P. 562)
- ⑨ Shift position and shift range
Displays the selected shift position or selected shift range (→P. 224)

■ Rev indicator (F SPORT models)

When the engine reaches a set speed while the tachometer is displayed, a ring-shaped indicator is displayed on the tachometer.

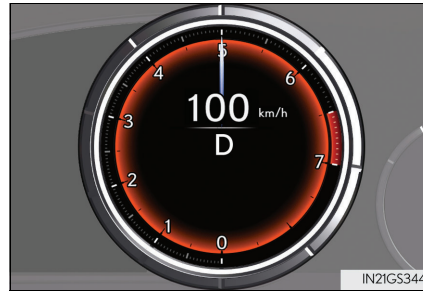

■ Rev peak (F SPORT models)

When the engine speed reaches or exceeds 5000 r/min while the tachometer is displayed, an afterimage of the tachometer needle is displayed at the highest engine speed for approximately 1 seconds.



Changing the display

Switches between odometer, trip meter and maintenance required information displays. When the trip meter is displayed, pressing and holding the button will reset the trip meter.

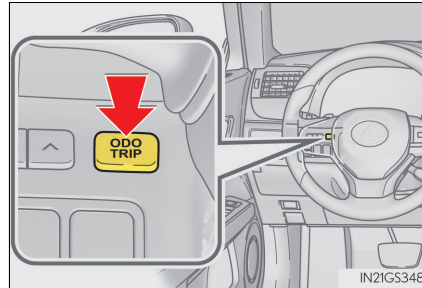

Instrument panel light control

The brightness of the instrument panel lights can be adjusted.

- ① Darker
- ② Brighter

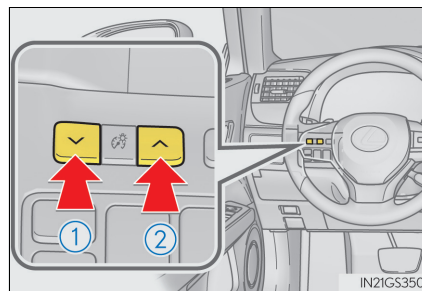

■ **The meters and display illuminate when**

The power switch is in ON mode.

■ **Instrument panel brightness adjustment**

The instrument panel brightness levels when the tail lights are on and off can be adjusted individually. However, when the surroundings are bright (daytime, etc.), turning on the tail lights will not change the instrument panel brightness.

■ **Limitation of brightness adjustment**

The brightness of the instrument panel lights is automatically adjusted based on the light sensor detecting how bright the surroundings are. However, if the instrument panel brightness has been manually set to either the brightest or darkest setting, the automatic adjustment will not be performed.

■ **Hybrid System Indicator**

- ① Charge area
Shows regenerative charging.
 - ② Hybrid Eco area
Shows that gasoline engine power is not being used very often.
The gasoline engine will automatically stop and restart under various conditions.
 - ③ Eco area
Shows that the vehicle is being driven in an Eco-friendly manner.
 - ④ Power area
Shows that an Eco-friendly driving range is being exceeded (during full power driving etc.)
- Hybrid System Indicator is displayed when the driving mode is other than the sport mode.
 - By keeping the indicator needle within Eco area, more Eco-friendly driving can be achieved.
 - Charge area indicates regeneration* status. Regenerated energy will be used to charge the battery.
- *: When used in this manual, "regeneration" refers to the conversion of energy created by the movement of the vehicle into electrical energy.

▶ Except F SPORT models

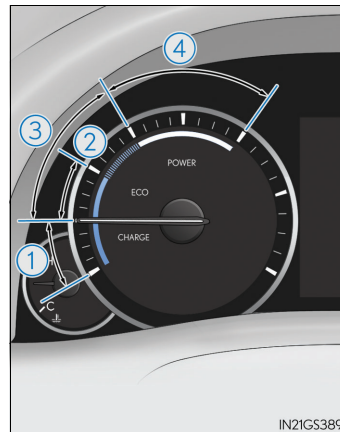

▶ F SPORT models

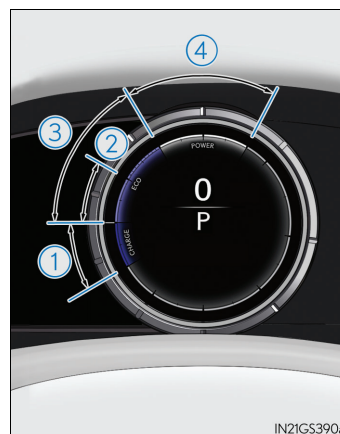

■ Tachometer

Hybrid System Indicator switches to the tachometer when driving mode is in sport mode. The settings of the tachometer display can be changed on the multi-information display. (→P. 111)

■ Engine speed

On hybrid vehicles, engine speed is precisely controlled in order to help improve fuel efficiency and reduce exhaust emissions etc. There are times when the engine speed that is displayed may differ even when vehicle operation and driving conditions are the same.

■ Outside temperature display

- In the following situations, the correct outside temperature may not be displayed, or the display may take longer than normal to change.
 - When stopped, or driving at low speeds (less than 20 km/h [12 mph])
 - When the outside temperature has changed suddenly (at the entrance/exit of a garage, tunnel, etc.)
 - When the vehicle is parked in direct sunlight
- When "--" or "E" is displayed, the system may be malfunctioning. Take your vehicle to any authorized Lexus retailer or Lexus authorized repairer, or any reliable repairer.

■ Pop-up display

In some situations, a pop-up display will be temporarily displayed on the multi-information display or the odometer/trip meter/maintenance required information screen. The pop-up display function can be set on/off. (→P. 563)

■ Liquid crystal display

Small spots or light spots may appear on the display. This phenomenon is characteristic of liquid crystal displays, and there is no problem continuing to use the display.

■ Clock settings

If the screen shown to the right is displayed when trying to change the time display method through  (→P. 111) on the multi-information display, the system may be malfunctioning. Have the vehicle inspected by any authorized Lexus retailer or Lexus authorized repairer, or any reliable repairer immediately.



■ Customization

The meter display can be customized on the multi-information display. (Customizable features →P. 561)

 **WARNING****■ The information display at low temperatures**

Allow the interior of the vehicle to warm up before using the liquid crystal information display. At extremely low temperatures, the information display monitor may respond slowly, and display changes may be delayed.

For example, there is a lag between the driver's shifting and the new gear number appearing on the display. This lag could cause the driver to downshift again, causing rapid and excessive engine braking and possibly an accident resulting in death or injury.

 **NOTICE****■ To prevent damage to the hybrid system and its components**

- While the tachometer is displayed, do not let the indicator needle of the tachometer enter the red zone, which indicates the maximum engine speed.
- The engine may be overheating if the engine coolant temperature gauge is in the red zone (H). In this case, immediately stop the vehicle in a safe place, and check the engine after it has cooled completely. (→P. 535)

Multi-information display

Display contents

The multi-information display presents the driver with a variety of vehicle data.

● Menu icons

▶ Except F SPORT models

▶ F SPORT models

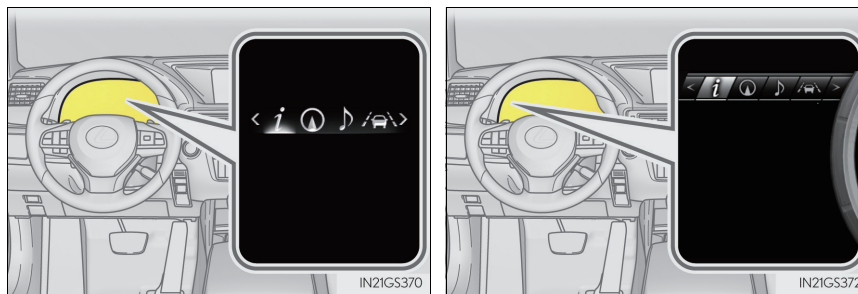

Displays the following information when an icon is selected. (→P. 113)

Some of the information may be displayed automatically depending on the situation.



Drive information

Select to display various drive data. (→P. 113)



Navigation system-linked display (if equipped)

Select to display the following navigation system-linked information.

- Route guidance
- Compass display (north-up display/heading-up display)



Audio system-linked display

Select to enable selection of an audio source or track on the display using the meter control switches.



Driving assist information

Select to display the cruise control or dynamic radar cruise control with full-speed range/LKA (Lane-Keeping Assist) (if equipped) information, when the system is used. (→P. 282, 296, 308)



Warning message display

Select to display warning messages and measures to be taken if a malfunction is detected. (→P. 466)







Settings display

Select to change the meter display settings. (→P. 562)

Operating the meter control switches

The multi-information display is operated using the meter control switches.

- ①   : Switch menu
  : Change displayed content, scroll up/down the screen and move the cursor up/down
- ② Press: Enter/Set
 Press and hold: Reset
- ③ Return to the previous screen
- ④ Press: Displays the screen registered to 

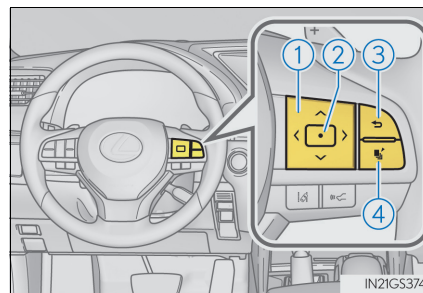





When no screen has been registered, the drive information screen will be displayed.

Press and hold: Registers the currently displayed screen to  (→P. 562)

When the confirmation screen is displayed, select yes to register the screen. If the selected screen cannot be registered, a registration failure message will be shown.

Drive information

Items displayed can be switched by pressing  or  of the meter control switches to select  and pressing  or .

■ Current fuel consumption*¹

Displays the current rate of fuel consumption

■ Average fuel economy (after reset*²/after start/after refuel)*¹

Displays the average fuel consumption since the function was reset, the hybrid system was started, and the vehicle was refueled, respectively

Use the displayed average fuel consumption as a reference.

■ Average speed (after reset*²/after start)*¹

Displays the average vehicle speed since the function was reset and the hybrid system was started, respectively

■ Elapsed time (after reset*²/after start)*¹

Displays the elapsed time since the function was reset and the hybrid system was started, respectively

■ Distance (range/after start)*¹

Displays the estimated maximum distance that can be driven with the quantity of fuel remaining and the distance driven after the hybrid system was started respectively.

- This distance is computed based on your average fuel consumption. As a result, the actual distance that can be driven may differ from that displayed.
- When only a small amount of fuel is added to the tank, the display may not be updated.

When refueling, turn the power switch off. If the vehicle is refueled without turning the power switch off, the display may not be updated.

■ Energy monitor

→P. 126

■ G-forces

Displays lateral G-forces on the vehicle

Also displays, around the periphery of the G-force display, the left and right steering amount, accelerator pedal input, and brake fluid pressure

- ① Acceleration G-force on the vehicle
- ② Current G-force value (analyzed value of front/rear and left/right G-forces)
- ③ Accelerator pedal input
- ④ Brake fluid pressure
- ⑤ Record of the maximum G-forces
- ⑥ Steering amount

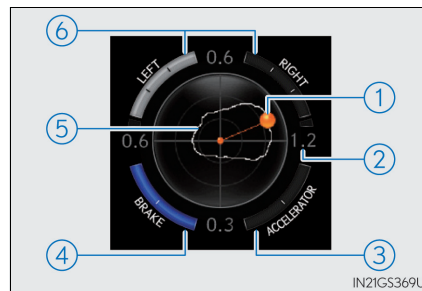

Actual vehicle conditions may differ from the displayed information depending on road conditions, temperature, vehicle speed and other factors.
Use this information as reference.

● Resetting the record of maximum G-forces

Press and hold  to reset the record.

● Peak hold function (F SPORT models)

If lateral G-forces of 0.5 G or greater are generated, the G-force value display will turn amber and be held for 2 seconds.

■ Tire inflation pressure (vehicles with the tire pressure warning system)

Displays inflation pressure of each tire.

The inflation pressure of the compact spare tire will not be displayed.

■ LKA (Lane-Keeping Assist) vehicle sway warning (if equipped)

→P. 282

■ Display off

A blank screen is displayed

*1: Displayed when the item is set in "Drive Info 1", "Drive Info 2" or "Drive Info 3".
(→P. 562)

*2: The function can be reset by pressing the  of the meter control switches for longer than 1 second when the item to reset is displayed.

If there is more than one item that can be reset, the item selection screen will appear.

Settings display

The settings of the following items can be changed, refer to P. 561

For functions that can be enabled or disabled, the function switches between on and off each time  is pressed.

■  **LKA** (Lane-Keeping Assist) (if equipped) (→P. 282)

■  **PCS** (Pre-Crash Safety system) (if equipped) (→P. 270)

■  **AFS** (Adaptive Front-lighting System) (if equipped) (→P. 239)

■  **BSM** (Blind Spot Monitor) (if equipped) (→P. 314)

■ Speed Warning

Select to turn the speed warning on and off, or to change the speed at which the speed warning is displayed.

■  **RSA** (Road Sign Assist) (if equipped) (→P. 291)

■ Clock



Select to set the display mode of the clock.

■ Vehicle Settings

● Oil Maintenance (→P. 408)

● TPMS (Tire pressure warning system) (if equipped) (→P. 418)

■ Meter Settings

- Language
 - Select to change the language on the display.
- Units
 - Select to change the unit of measure.
- EV indicator
 - Select to activate/deactivate the EV indicator.
-  switch
 - Displays a procedure to register a desired screen to . You can register 1 screen as a shortcut, which can be displayed by pressing .
- Drive information 1/2/3
 - Select to select up to 2 items that will be displayed on a Drive information screen, up to 3 Drive information screens can be set.
- Pop-up display
 - Select to set the following pop-up displays, which may appear in some situations, on/off.
 - Route guidance of the navigation system-linked display (if equipped)
 - Incoming call display of the hands-free phone system
 - Instrument panel brightness adjustment display
- Accent color (except F SPORT models)
 - Select to change the accent colors on the screen, such as the cursor color.
- Needle (F SPORT models)
 - Select to change the needle color for the tachometer.
- Rev indicator (F SPORT models)
 - Select to set the rev indicator on/off. When set to on, proceed to set the engine speed at which the rev indicator will be displayed.
 - Selectable engine speed range:
2000 r/min to 6000 r/min
- Rev peak (F SPORT models)
 - Select to set the rev peak on/off.
- Tachometer
 - Select to set the tachometer or Hybrid System Indicator to always be displayed or be changed to automatically according to the driving mode.
- Default settings
 - Registered or changed meter settings will be deleted or returned to their default setting.

■ G-force display

- The G-force values may not be zero even when the vehicle is parked, such as when it is parked on an incline.
- Depending on the vehicle usage conditions, the brake fluid pressure display may not reach its maximum reading even though the brake pedal is fully depressed.
- If a 12-volt battery terminal is disconnected and reconnected, the steering amount display may be disabled temporarily. After driving the vehicle for a while, the display will be enabled.
- Depending on the condition of the vehicle, the brake fluid pressure display may change even when the brake pedal is not depressed.

■ System check display

After turning the power switch to ON mode, opening image is displayed while system operation is checked. When the system check is complete, the normal screen will return.

■ Suspension of the settings display

In the following situations, the settings display using the meter control switches will be suspended.

- When a warning message appears on the multi-information display
- When the vehicle begins to move

■ Tire inflation pressure (if equipped)

- It may take a few minutes to display the tire inflation pressure after the power switch is turned to ON mode. It may also take a few minutes to display the tire inflation pressure after inflation pressure has been adjusted.
- “---” may be displayed if the tire information cannot be determined due to unfavorable radio wave conditions.
- Tire inflation pressure changes with temperature. The displayed values may also be different from the values measured using a tire pressure gauge.

■ When disconnecting and reconnecting 12-volt battery terminals

The drive information will be reset.

■ Liquid crystal display

→P. 109

 **WARNING****■ Caution for use while driving**

- When operating the multi-information display while driving, pay extra attention to the safety of the area around the vehicle.
- Do not look continuously at the multi-information display while driving as you may fail to see pedestrians, objects on the road, etc. ahead of the vehicle.

■ Cautions during setting up the display

As the hybrid system needs to be operating during setting up the display, ensure that the vehicle is parked in a place with adequate ventilation. In a closed area such as a garage, exhaust gases including harmful carbon monoxide (CO) may collect and enter the vehicle. This may lead to death or a serious health hazard.

 **NOTICE****■ During setting up the display**

To prevent 12-volt battery discharge, ensure that the hybrid system is operating while setting up the display features.

Head-up display*

Summary of functions

The head-up display can be used to project vehicle speed and other information onto the windshield.

- ① Head-up display
Display brightness will change automatically according to the brightness of the surrounding area.
- ② "HUD" button
- ③ Display brightness adjustment switch
Display brightness can be adjusted to the desired level.
- ④ Display position adjustment switch
- ⑤ "DISP" button

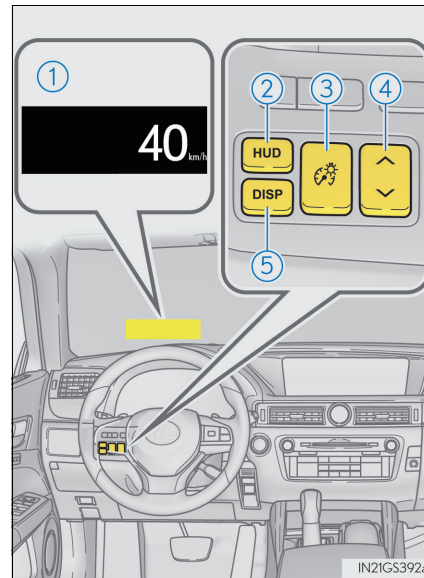

2

Instrument cluster

*: If equipped

Head-up display contents

- Vehicle speed
- Hybrid System Indicator (→P. 123)
- Tachometer
- Shift position and shift range
 - Displays the selected shift position or selected shift range (→P. 224)
- Road signs recognized by the RSA (Road Sign Assist) (if equipped) (→P. 291)
- Audio display*
 - Displays audio information for approximately 3 seconds when the audio system is operated
- Route guidance display (vehicles with navigation system) (→P. 123)
 - When approaching an intersection while the navigation system is giving route guidance, an arrow will automatically be displayed to indicate the direction of travel.
- Lane departure warning display (LKA [Lane-Keeping Assist]) (if equipped) (→P. 467)
- Approach warning display (dynamic radar cruise control with full-speed range) (if equipped) (→P. 467)
- Pre-crash warning message (PCS [Pre-Crash Safety system]) (if equipped) (→P. 466)

*: The default setting is off

Switching the head-up display

■ “HUD” button

Pressing the switch turns the head-up display on/off and changes the vehicle speed display units as follows:

▶ Type A

OFF → ON (km/h) → OFF

▶ Type B

OFF → ON (mph) →

ON (km/h) → OFF

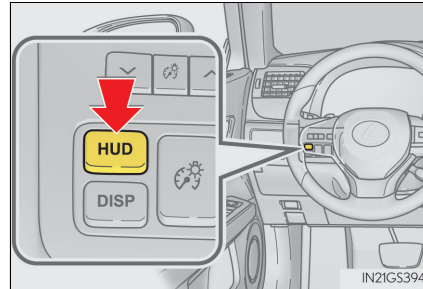

■ “DISP” button

Pressing the button changes the display items (except vehicle speed).

- ① Off
- ② Hybrid System Indicator
- ③ Tachometer

When any of the following displays are operating, the display items do not change (except vehicle speed): RSA (Road Sign Assist) (if equipped)/Audio display/Route guidance display (vehicles with navigation system)/Lane departure warning display (if equipped)/Approach warning display (if equipped)/Pre-crash warning message (if equipped).

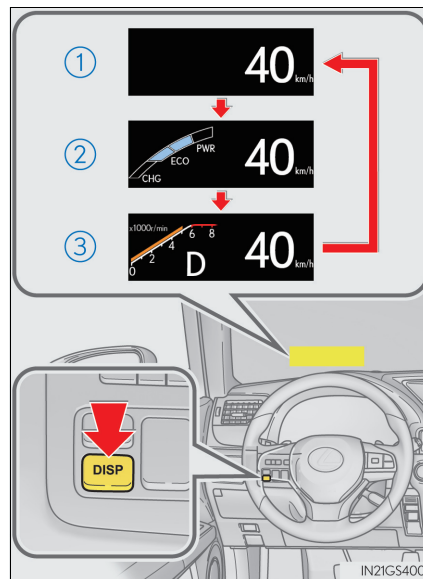

Making the display easier to see

■ Adjusting the display position

- ① Higher
- ② Lower

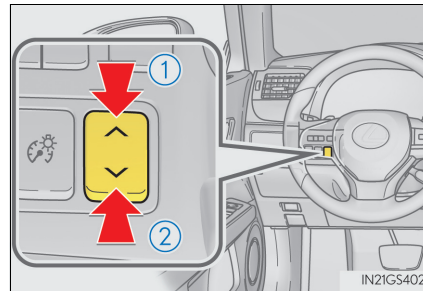

■ Setting the brightness

The brightness of the display is automatically adjusted in accordance with the brightness of the surrounding environment. However, the brightness can also be manually adjusted in 9 stages.

- ① Brighter
- ② Darker

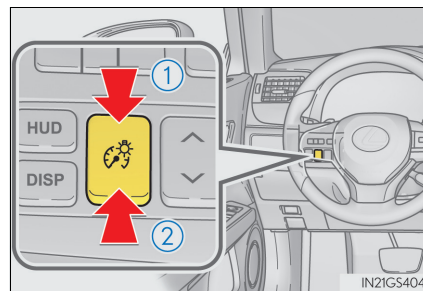

Hybrid System Indicator

- ① Charge area
Shows regenerative charging.
- ② Hybrid Eco area
Shows that gasoline engine power is not being used very often.
The gasoline engine will automatically stop and restart under various conditions.
- ③ Eco area
Shows that the vehicle is being driven in an Eco-friendly manner.
- ④ Power area
Shows that an Eco-friendly driving range is being exceeded (during full power driving etc.)

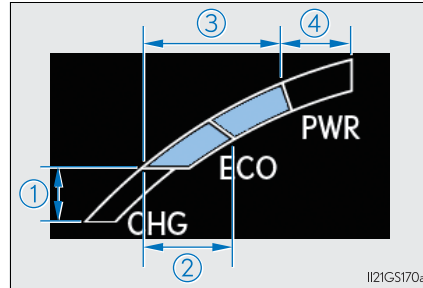

2

Instrument cluster

Route guidance display (vehicles with navigation system)

When the vehicle approaches an intersection, the direction the vehicle should go is guided by the arrow.

When the vehicle approaches an intersection, the route guidance will start and the distance* to the intersection will also be displayed.

*: The distance decreases in increments of 50 m (164 ft.) and the distance indication will disappear when the vehicle passes through the intersection.

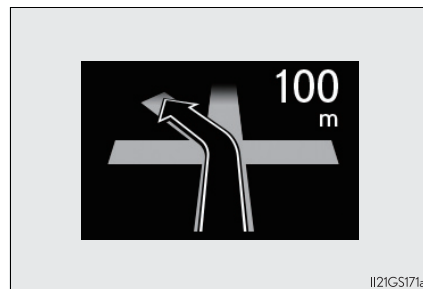

Display customization

Display of the following screens can be switched on or off.

- Audio display
- Route guidance display (vehicles with navigation system)

■ Changing the settings

- 1 Continue holding the “DISP” button until the screen changes, and repeat the process until the setting you want to change is displayed.

Customization can be performed when the head-up display is on and the vehicle is traveling at less than 8 km/h (5 mph).

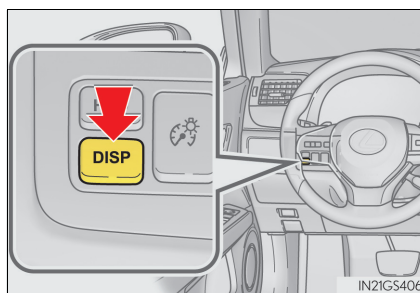

- 2 Press the “DISP” button to switch between on and off.

On and off will be switched between each time the button is pressed.

If the button is left alone without being operated for a short time, setting will be finished automatically.

■ Head-up display

- The head-up display may seem dark and hard to see when viewed through sunglasses, especially polarized sunglasses.
Adjust the brightness of the head-up display or remove your sunglasses.
- When the head-up display is turned off, it will remain off even if the power switch is turned to ON mode after the power switch has been turned off.
- The startup image will be displayed on the head-up display after the power switch has been turned to ON mode while the head-up display switch is set to on.

■ When the 12-volt battery is disconnected

The customize settings of the head-up display will be reset.

■ Head-up display automatic position adjustment

If the display position is recorded into memory, the head-up display will be automatically adjusted to the desired position. (→P. 178)

⚠ WARNING**■ Before using the head-up display**

Check that the position and brightness of the head-up display image does not interfere with safe driving. Incorrect adjustment of the image's position or brightness may obstruct the driver's view and lead to an accident, resulting in death or serious injury.

⚠ NOTICE**■ To prevent damage to components**

- Do not place any drinks near the head-up display projector. If the projector gets wet, electrical malfunctions may result.
- Do not place anything on or put stickers onto the head-up display projector. Doing so could interrupt head-up display indications.

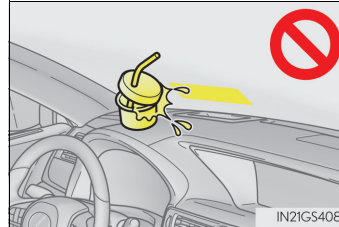

- Do not touch the inside of the head-up display projector or thrust sharp edges or the like into the projector. Doing so could cause mechanical malfunctions.

Energy monitor/consumption screen

You can view the status of your hybrid system on the multi-information display and the Remote Touch screen.

Vehicles with 12.3-inch display: The energy monitor or consumption screen can be displayed on the side display.

- ① Multi-information display
- ② Remote Touch screen
- ③ Meter control switches
- ④ "MENU" button
- ⑤ Remote Touch knob
- ⑥ "ENTER" buttons

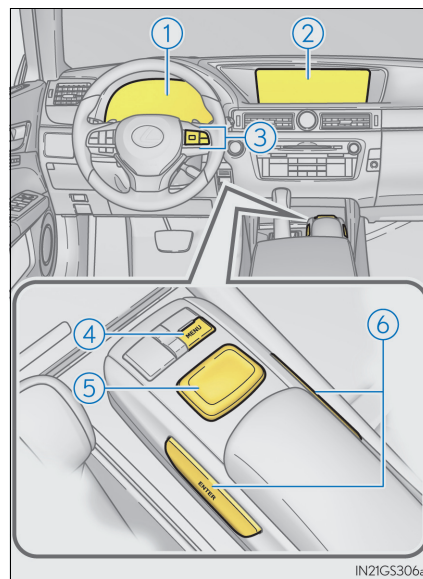

Energy monitor





■ Remote Touch screen



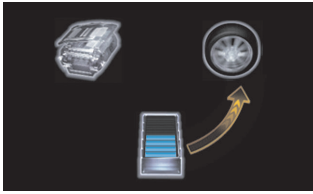

Press the "MENU" button on the Remote Touch, and then select  on the "Menu" screen.

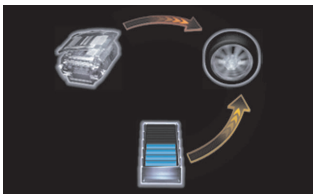
If the "Trip information" or "Past record" screen is displayed, select "Energy".

■ Multi-information display

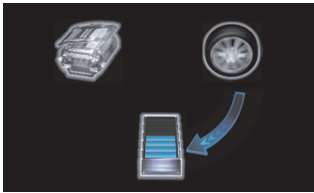
Press **<** or **>** of the meter control switches and select **i**, and then press **▲** or **▼** to select the energy monitor display.

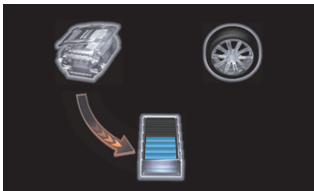
Remote Touch screen	Multi-information display
When the vehicle is powered by the electric motor (traction motor)	
 <p>The Remote Touch screen shows a top-down view of the vehicle with labels for 'Engine', 'Electric motor', and 'Battery'. Yellow arrows indicate energy flow from the battery to the electric motor. At the bottom, there are buttons for 'Trip information' and 'Past record'.</p>	 <p>The Multi-information display shows a simplified top-down view of the vehicle, a battery icon, and a wheel icon. A yellow arrow points from the battery icon to the wheel icon.</p>
When the vehicle is powered by both the gasoline engine and the electric motor (traction motor)	
 <p>The Remote Touch screen shows a top-down view of the vehicle with labels for 'Engine', 'Electric motor', and 'Battery'. Yellow arrows indicate energy flow from both the engine and the battery to the electric motor. At the bottom, there are buttons for 'Trip information' and 'Past record'.</p>	 <p>The Multi-information display shows a simplified top-down view of the vehicle, a battery icon, and a wheel icon. Yellow arrows point from both the vehicle's engine area and the battery icon to the wheel icon.</p>
When the vehicle is powered by the gasoline engine	
 <p>The Remote Touch screen shows a top-down view of the vehicle with labels for 'Engine', 'Electric motor', and 'Battery'. A yellow arrow indicates energy flow from the engine to the electric motor. At the bottom, there are buttons for 'Trip information' and 'Past record'.</p>	 <p>The Multi-information display shows a simplified top-down view of the vehicle and a wheel icon. A yellow arrow points from the vehicle's engine area to the wheel icon.</p>

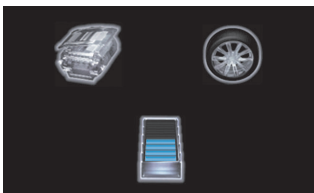
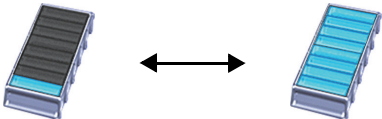
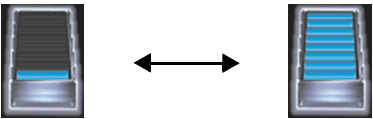
Remote Touch screen	Multi-information display
When the vehicle is charging the hybrid battery (traction battery)	
	
	
When there is no energy flow	
	
Hybrid battery (traction battery) status	
<p style="text-align: center;">Low Full</p> 	<p style="text-align: center;">Low Full</p> 

These images are examples only, and may vary slightly from actual conditions.

Consumption

Press the "MENU" button on the Remote Touch, then select  on the "Menu" screen.

■ Trip information

If the "Energy monitor" or "Past record" screen is displayed, select "Trip information".

- ① Resetting the consumption data
- ② Fuel consumption in the past 15 minutes
- ③ Current fuel consumption
- ④ Regenerated energy in the past 15 minutes

One symbol indicates 50 Wh. Up to 5 symbols are shown.

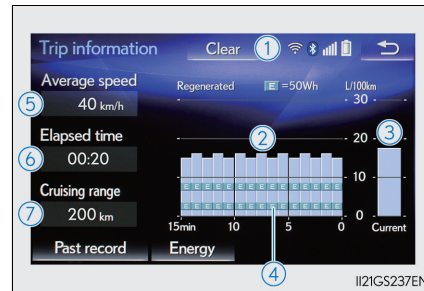

- ⑤ Average vehicle speed since the hybrid system was started.
- ⑥ Elapsed time since the hybrid system was started.
- ⑦ Cruising range (→P. 130)

Average fuel consumption for the past 15 minutes is divided by color into past averages and averages attained since the power switch was last turned to ON mode. Use the displayed average fuel consumption as a reference.

The image is an example only, and may vary slightly from actual conditions.

■ Past record

If the “Energy monitor” or “Trip information” screen is displayed, select “Past record”.

- ① Resetting the past record data
- ② Best recorded fuel consumption
- ③ Average fuel consumption
- ④ Previous fuel consumption record
- ⑤ Updating the average fuel consumption data

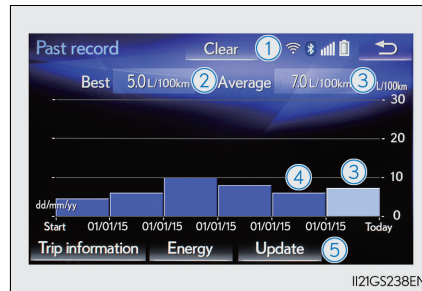

The average fuel consumption history is divided by color into past averages and the average fuel consumption since the last updated. Use the displayed average fuel consumption as a reference.

The image is an example only, and may vary slightly from actual conditions.

■ Updating the past record data

Update the average fuel consumption by selecting “Update” to measure the current fuel consumption again.

■ Resetting the data

The fuel consumption data can be deleted by selecting “Clear”.

■ Cruising range

Displays the estimated maximum distance that can be driven with the quantity of fuel remaining.

This distance is computed based on your average fuel consumption.

As a result, the actual distance that can be driven may differ from that displayed.

Using the side display (vehicles with 12.3-inch display)

Vehicle information can be displayed on the side display (→P. 345), then select **<** or **>** to select the desired screen.

► Fuel consumption

Displays the average fuel consumption and regenerated energy for the past 10 minutes in 1 minute intervals, as well as the cruising range.

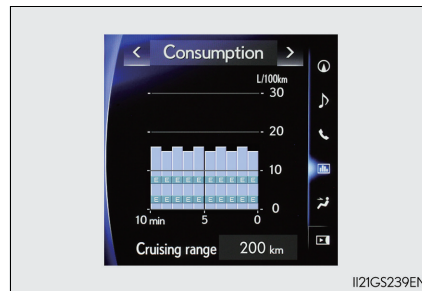

► Past record

Displays the average fuel consumption and highest fuel consumption.



► Trip information

Displays the cruising range, average fuel consumption and the amount of time elapsed since the hybrid system was started.

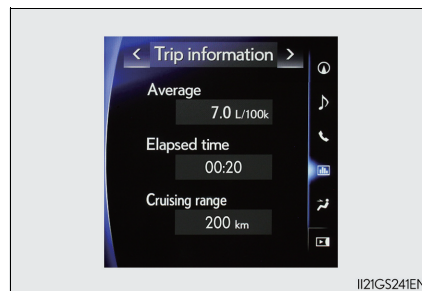

► Energy monitor

Displays the hybrid system operation and energy recovery states.

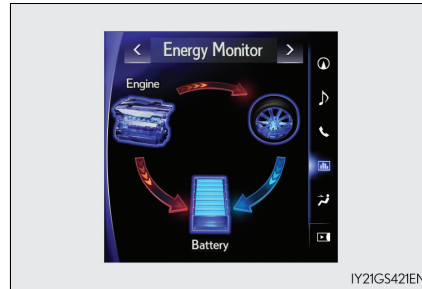

The image is an example only, and may vary slightly from actual conditions.

**Operation of
each component****3**

- 3-1. Key information**
 - Keys 134
- 3-2. Opening, closing and locking the doors and trunk**
 - Doors 139
 - Trunk 146
 - Smart entry & start system 153
- 3-3. Adjusting the seats**
 - Front seats 175
 - Driving position memory 178
 - Head restraints 183
- 3-4. Adjusting the steering wheel and mirrors**
 - Steering wheel 186
 - Inside rear view mirror 188
 - Outside rear view mirrors 190
- 3-5. Opening, closing the windows and moon roof**
 - Power windows 193
 - Moon roof 196

Keys

The keys

The following keys are provided with the vehicle.

- ① Electronic keys
 - Operating the smart entry & start system (→P. 153)
 - Operating the wireless remote control function
- ② Mechanical keys
- ③ Key number plate
- ④ Card key (electronic key) (if equipped)

Operating the smart entry & start system (→P. 153)

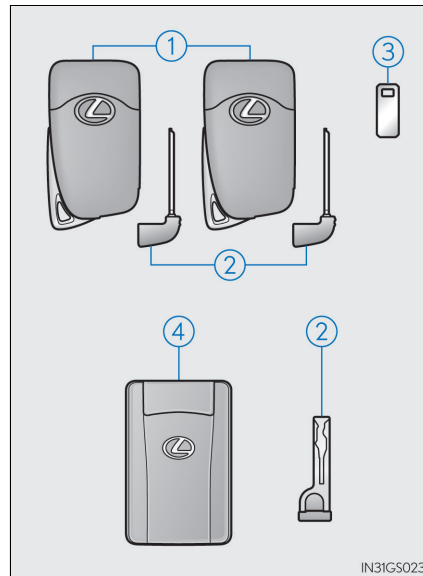

IN31GS023

Wireless remote control

- ① Locks all the doors (→P. 139)
- ② Closes the windows and moon roof (if equipped)* (→P. 139)
- ③ Unlocks all the doors (→P. 139)
- ④ Opens the windows and moon roof (if equipped)* (→P. 139)
- ⑤ Opens the trunk (→P. 147)

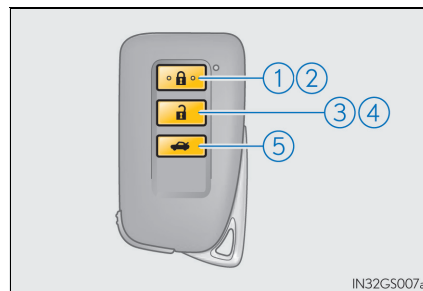

IN32GS007a

*: These settings must be customized at any authorized Lexus retailer or Lexus authorized repairer, or any reliable repairer.

Using the mechanical key

To take out the mechanical key, push the release button and take the key out.

The mechanical key can only be inserted in one direction, as the key only has grooves on one side. If the key cannot be inserted in a lock cylinder, turn it over and re-attempt to insert it.

After using the mechanical key, store it in the electronic key. Carry the mechanical key together with the electronic key. If the electronic key battery is depleted or the entry function does not operate properly, you will need the mechanical key. (→P. 527)

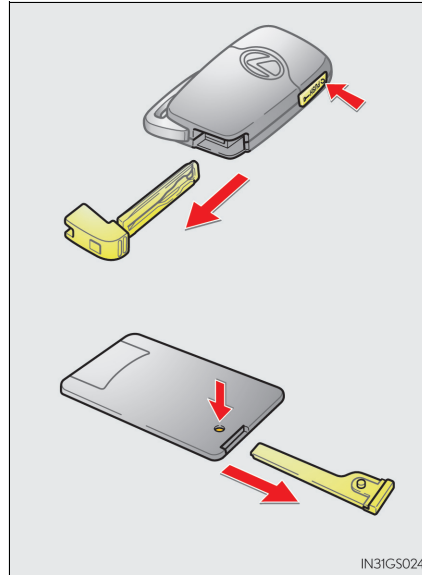

■ Card key (if equipped)

- The card key is not waterproof.
- The mechanical key that is stored inside the card key should be used only if a problem arises, such as when the card key does not operate properly.
- If it is difficult to take out the mechanical key, push down the lock release button using a pen tip etc. If it is still difficult to pull it out, use a coin etc.
- To store the mechanical key in the card key, insert it while pressing the lock release button.

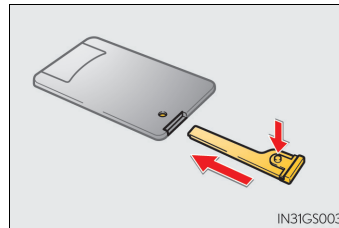

- If the battery cover is not installed and the battery falls out or if the battery was removed because the key got wet, reinstall the battery with the positive terminal facing the Lexus emblem.

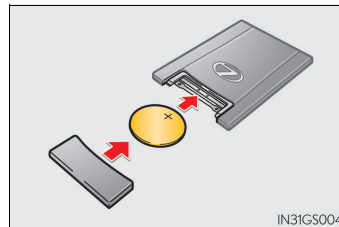

■ When required to leave the vehicle's key with a parking attendant

Turn the trunk opener main switch off and lock the glove box as circumstances demand. (→P. 148, 370)
Remove the mechanical key for your own use and provide the attendant with the electronic key only.

■ If you lose your mechanical keys

New genuine mechanical keys can be made by any authorized Lexus retailer or Lexus authorized repairer, or any reliable repairer using the other mechanical key and the key number stamped on your key number plate. Keep the plate in a safe place such as your wallet, not in the vehicle.

■ When riding in an aircraft

When bringing an electronic key onto an aircraft, make sure you do not press any buttons on the electronic key while inside the aircraft cabin. If you are carrying an electronic key in your bag etc., ensure that the buttons are not likely to be pressed accidentally. Pressing a button may cause the electronic key to emit radio waves that could interfere with the operation of the aircraft.

■ Electronic key battery depletion

- The standard battery life is 1 to 2 years. (The card key battery life is about a year and a half.)
- If the battery becomes low, an alarm will sound in the cabin when the hybrid system stops. (→P. 496)
- As the electronic key always receives radio waves, the battery will become depleted even if the electronic key is not used. The following symptoms indicate that the electronic key battery may be depleted. Replace the battery when necessary. (→P. 435)
 - The smart entry & start system or the wireless remote control does not operate.
 - The detection area becomes smaller.
 - The LED indicator on the key surface does not turn on.
- To avoid serious deterioration, do not leave the electronic key within 1 m (3 ft.) of the following electrical appliances that produce a magnetic field:
 - TVs
 - Personal computers
 - Cellular phones, cordless phones and battery chargers
 - Recharging cellular phones or cordless phones
 - Table lamps
 - Induction cookers

■ Replacing the battery

→P. 435

■ Confirmation of the registered key number

The number of keys already registered to the vehicle can be confirmed. Ask any authorized Lexus retailer or Lexus authorized repairer, or any reliable repairer for details.

■ If a wrong key is used

The key cylinder rotates freely to isolate inside mechanism.

 NOTICE**■ To prevent key damage**

- Do not drop the keys, subject them to strong shocks or bend them.
- Do not expose the keys to high temperatures for long periods of time.
- Do not get the keys wet or wash them in an ultrasonic washer etc.
- Do not attach metallic or magnetic materials to the keys or place the keys close to such materials.
- Do not disassemble the keys.
- Do not attach a sticker or anything else to the surface of the electronic key.
- Do not place the keys near objects that produce magnetic fields, such as TVs, audio systems and induction cookers.
- Do not place the keys near medical electrical equipment such as low-frequency therapy equipment or microwave therapy equipment, and do not receive medical attention with the keys on your person.

■ Carrying the electronic key on your person

Carry the electronic key 10 cm (3.9 in.) or more away from electric appliances that are turned on. Radio waves emitted from electric appliances within 10 cm (3.9 in.) of the electronic key may interfere with the key, causing the key to not function properly.

■ In case of a smart entry & start system malfunction or other key-related problems

Take your vehicle with all the electronic keys provided with your vehicle, including the card key, to any authorized Lexus retailer or Lexus authorized repairer, or any reliable repairer.

■ When an electronic key is lost

If the electronic key remains lost, the risk of vehicle theft increases significantly. Visit any authorized Lexus retailer or Lexus authorized repairer, or any reliable repairer immediately with all remaining electronic keys and the card key that was provided with your vehicle.



NOTICE

■ Handling the card key (if equipped)

- Do not apply excess force when inserting the mechanical key into the card key. Doing so may damage the card key.
- If the battery or card key terminals get wet, the battery may corrode.
If the key is dropped into water, or if drinking water etc. is spilled on the key, immediately remove the battery cover and wipe the battery and terminals. (To remove the battery cover, lightly grasp and pull it.) If the battery is corroded, have any authorized Lexus retailer or Lexus authorized repairer, or any reliable repairer replace the battery.
- Do not crush the battery cover or use a screwdriver to remove the battery cover. Forcibly removing the battery cover may bend or damage the key.
- If the battery cover is frequently removed, the battery cover may become loose.
- When installing the battery, make sure to check the direction of the battery.
Installing the battery in the wrong direction may cause the battery to deplete rapidly.
- The surface of the card key may be damaged, or its coating may peel off in the following situations:
 - The card key is carried together with hard objects, such as coins and keys.
 - The card key is scraped with a sharp object, such as the tip of a mechanical pencil.
 - The surface of the card key is wiped with thinner or benzene.

Doors

Unlocking and locking the doors from the outside

◆ Smart entry & start system (vehicles with entry function)

Carry the electronic key to enable this function.

- ① Grip the handle to unlock the doors.

Make sure to touch the sensor on the back of the handle.

The doors cannot be unlocked for 3 seconds after the doors are locked.

- ② Touch the lock sensor (the indentation on the upper part of the door handle) to lock the doors.

Check that the door is securely locked.

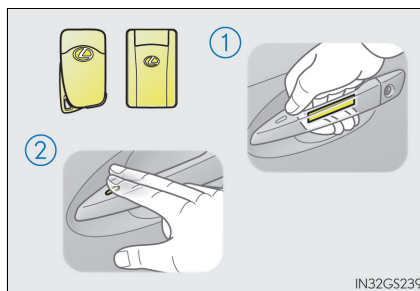

◆ Wireless remote control

- ① Locks all the doors

Check that the door is securely locked.

Press and hold to close the windows and moon roof. (if equipped)*

- ② Unlocks all the doors

Press and hold to open the windows and moon roof. (if equipped)*

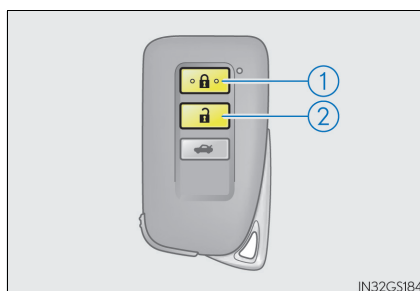

*: These settings must be customized at any authorized Lexus retailer or Lexus authorized repairer, or any reliable repairer.

■ Operation signals

The emergency flashers flash to indicate that the doors have been locked/unlocked. (Locked: once; Unlocked: twice)

■ Security feature

If a door is not opened within approximately 30 seconds after the vehicle is unlocked, the security feature automatically locks the vehicle again.

■ Welcome light illumination control

The front position, tail and license plate lights automatically turn on at night when the doors are unlocked using the entry function or wireless remote control if the light switch is in the "AUTO" position.

■ When the door cannot be locked by the lock sensor on the upper part of the door handle (vehicles with entry function)

If the door will not lock even when the topside sensor area is touched, try touching both the topside and underside sensor areas at the same time.

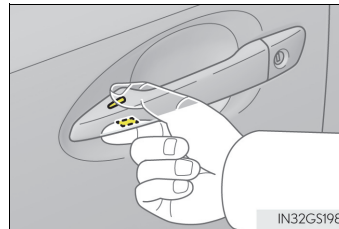
**■ Door lock buzzer**

If an attempt to lock the doors is made when a door is not fully closed, a buzzer sounds continuously for 5 seconds. Fully close the door to stop the buzzer, and lock the vehicle once more.

■ Setting the alarm

Locking the doors will set the alarm system. (→P. 91)

■ If the smart entry & start system or wireless remote control does not operate properly

- Use the mechanical key to lock and unlock the doors. (→P. 527)
- Replace the key battery with a new one if it is depleted. (→P. 435)

 **WARNING**

Observe the following precautions.
Failing to do so may result in death or serious injury.

■ **When using the wireless remote control and operating the power windows or moon roof (if equipped)**

Operate the power window or moon roof after checking to make sure that there is no possibility of any passenger having any of their body parts caught in the window or moon roof. Also, do not allow children to operate the wireless remote control. It is possible for children and other passengers to get caught in the power window or moon roof.

■ **Jam protection function**

- Never try jamming any part of your body to activate the jam protection function intentionally.
- The jam protection function may not work if something gets caught just before the window or moon roof fully closes.

Unlocking and locking the doors from the inside

◆ Door lock switches

- ① Locks all the doors
- ② Unlocks all the doors

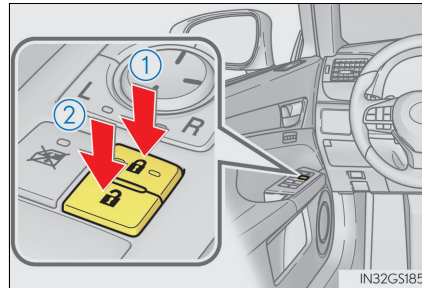

◆ Inside lock buttons

- ① Locks the door
- ② Unlocks the door

The front doors can be opened by pulling the inside handle even if the lock buttons are in the lock position.

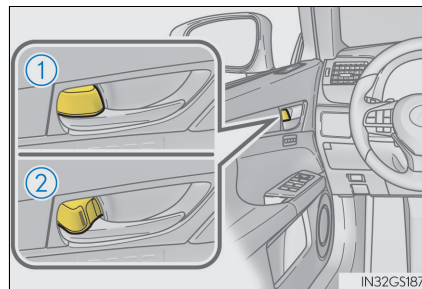

Locking the front doors from the outside without a key

- 1 Move the inside lock button to the lock position.
- 2 Close the door while pulling the door handle.

The door cannot be locked if the power switch is in ACCESSORY or ON mode, or the electronic key is left inside the vehicle. However, the key may not be detected correctly and the door may be locked.

Rear door child-protector lock

The door cannot be opened from inside the vehicle when the lock is set.

- ① Unlock
- ② Lock

These locks can be set to prevent children from opening the rear doors. Push down on each rear door switch to lock both rear doors.

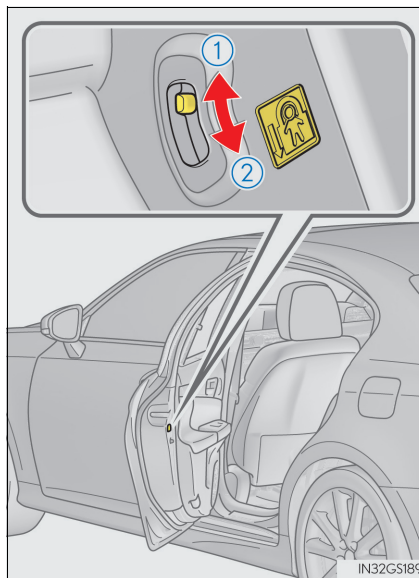

Automatic door locking and unlocking systems



The following functions can be set or canceled:

For instructions on customizing, refer to P. 561.



Function	Operation
Speed linked door locking function	All doors are automatically locked when vehicle speed is approximately 20 km/h (12 mph) or higher.
Shift position linked door locking function	All doors are automatically locked when shifting the shift lever to position other than P.
Shift position linked door unlocking function	All doors are automatically unlocked when shifting the shift lever to P.
Driver's door linked door unlocking function	All the doors are unlocked when the driver's door is opened within approximately 45 seconds after turning the power switch off.

■ Switching the door unlock function (vehicles with entry function)

It is possible to set which doors the entry function unlocks using the wireless remote control.

- 1 Turn the power switch off.
- 2 Cancel the intrusion sensor and tilt sensor of the alarm system to prevent unintended triggering of the alarm during the setting change. (if equipped) (→P. 94)
- 3 When the indicator light on the key surface is not on, press and hold  or  for approximately 5 seconds while pressing and holding .

The setting changes each time an operation is performed, as shown below. (When changing the setting continuously, release the buttons, wait for at least 5 seconds, and repeat step 3.)

Multi-information display	Unlocking function	Beep
 (Left-hand drive vehicles)	Holding the driver's door handle unlocks only the driver's door.	Exterior: Beeps 3 times Interior: Pings once
 (Right-hand drive vehicles)	Holding a passenger's door handle unlocks all the doors.	
	Holding a door handle unlocks all the doors.	Exterior: Beeps twice Interior: Pings once

For vehicles with alarm: To prevent unintended triggering of the alarm, unlock the doors using the wireless remote control and open and close a door once after the settings have been changed. (If a door is not opened within 30 seconds after  is pressed, the doors will be locked again and the alarm will automatically be set.)

In case that the alarm is triggered, immediately stop the alarm. (→P. 92)

■ Impact detection door lock release system

In the event that the vehicle is subject to a strong impact, all the doors are unlocked. Depending on the force of the impact or the type of accident, however, the system may not operate.

■ Using the mechanical key

The doors can also be locked and unlocked with the mechanical key. (→P. 527)

■ Conditions affecting the operation of the smart entry & start system or wireless remote control

→P. 155

■ Customization

Settings (e.g. unlocking function using a key) can be changed.
(Customizable features: →P. 561)

⚠ WARNING**■ To prevent an accident**

Observe the following precautions while driving the vehicle. Failure to do so may result in a door opening and an occupant throwing out of the vehicle, resulting in death or serious injury.

- Ensure that all doors are properly closed.
- Do not pull the inside handle of the doors while driving.
Be especially careful for the front doors, as the doors may be opened even if the inside lock buttons are in locked position.
- Set the rear door child-protector locks when children are seated in the rear seats.

Trunk

The trunk can be opened using the trunk opener, entry function or wireless remote control.

If the vehicle is equipped with a power trunk lid, the trunk can be closed using the trunk closer.

Opening the trunk from inside the vehicle

Press the opener switch.

If the vehicle is equipped with a power trunk lid, the trunk lid automatically opens fully.

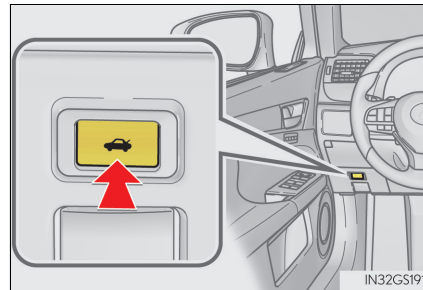

Opening the trunk from outside the vehicle

◆ Smart entry & start system (vehicles with entry function)

While carrying the electronic key, press the button.

When all the doors are unlocked with the power door lock system, the trunk can be opened without carrying the electronic key.

If the vehicle is equipped with a power trunk lid, the trunk lid automatically opens fully.

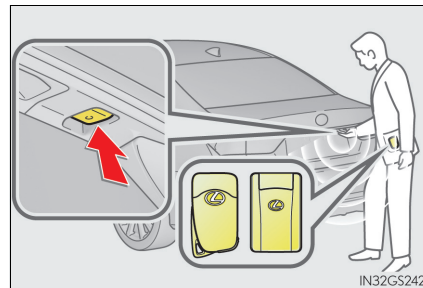

◆ Wireless remote control

Press and hold the switch.

If the vehicle is equipped with a power trunk lid, the trunk lid automatically opens fully.

**Trunk closer switch (vehicles with power trunk lid)**

Pressing the switch closes the trunk lid automatically. (A buzzer sounds.)

Pressing the switch while the trunk lid is closing opens the trunk lid again.

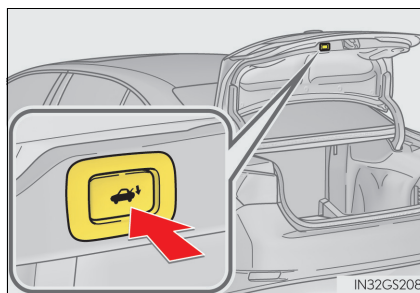
**When closing the trunk**

Using the trunk grip, lower the trunk without applying force to the side and push the trunk down from the outside to close it.

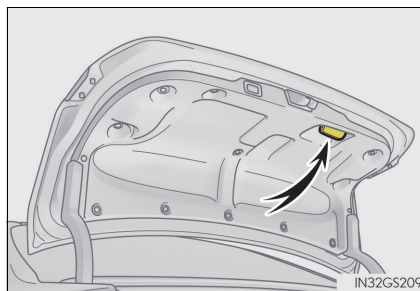

Luggage security system

The trunk opener switch can be temporarily disabled to protect luggage stored in the trunk against theft.

Turn the main switch in the glove box off to disable the trunk opener.

- ① On
- ② Off

The trunk lid cannot be opened even with the wireless remote control or the trunk release button.

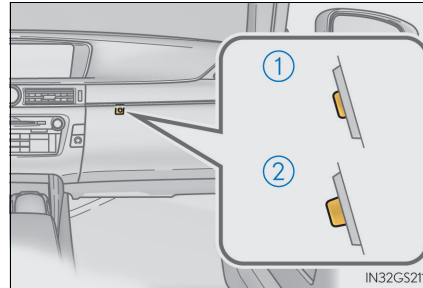

■ Operation signals

Wireless remote control: A buzzer sounds to indicate that the trunk has been unlocked.

■ Trunk light

The trunk light turns on when the trunk is opened.

■ Trunk easy closer

In the event that the trunk lid is left slightly open, the trunk easy closer will automatically close it to the fully closed position.

■ Function to prevent the trunk being locked with the electronic key inside

- When all doors are being locked, closing the trunk lid with the electronic key left inside the trunk will sound an alarm.
In this case, the trunk lid can be opened pressing the trunk release button on the trunk lid.
- Even when the spare electronic key is put in the trunk with all the doors locked, the key confinement prevention function can be activated so the trunk can be opened. In order to prevent theft, take all electronic keys with you when leaving the vehicle.
- Even when the electronic key is put in the trunk with all the doors are locked, the key may not be detected depending on the places and the surrounding radio wave conditions. In this case, the key confinement prevention function cannot be activated, causing the doors to lock when the trunk is closed. Make sure to check where the key is before closing the trunk.
- The key confinement prevention function cannot be activated if any one of the doors is unlocked. In this case, open the trunk using the trunk opener.

■ Overload protection function (vehicles with power trunk lid)

The trunk lid will not operate when excessive load is present on the top of the trunk lid.

■ Fall-down protection function (vehicles with power trunk lid)

While the trunk lid is opening automatically, applying excessive force to it will stop the opening operation to prevent the trunk lid from rapidly falling down.

■ **Jam protection function (vehicles with power trunk lid)**

While the trunk lid is closing automatically, the trunk lid will stop closing and open if something gets caught.

■ **If the smart entry & start system or wireless remote control does not operate properly**

- Use the mechanical key to open the trunk. (→P. 527)
- Replace the key battery with a new one if it is depleted. (→P. 435)

■ **When leaving a key to the vehicle with a parking attendant**

→P. 136

■ **Customization**

The trunk unlocking operation can be changed.
(Customizable features: →P. 566)

 **WARNING**

Observe the following precautions.
Failure to do so may result in death or serious injury.

■ **Before driving**

- Make sure that the trunk lid is fully closed. If the trunk lid is not fully closed, it may open unexpectedly while driving and hit near-by objects or luggage in the trunk may be thrown out, causing an accident.
- Do not allow children to play in the trunk.
If a child is accidentally locked in the trunk, they could suffer from heat exhaustion, suffocation or other injuries.
- Do not allow a child to open or close the trunk lid.
Doing so may cause the trunk lid to open unexpectedly, or cause the child's hands, head, or neck to be caught by the closing trunk lid.

■ **Important points while driving**

Never let anyone sit in the trunk. In the event of sudden braking or a collision, they are susceptible to death or serious injury.

⚠ WARNING**■ Using the trunk**

Observe the following precautions.

Failure to do so may cause parts of the body to be caught, resulting in serious injury.

- Remove any heavy loads, such as snow and ice, from the trunk lid before opening it. Failure to do so may cause the trunk lid to suddenly shut again after it is opened.
- When opening or closing the trunk lid, thoroughly check to make sure the surrounding area is safe.
- If anyone is in the vicinity, make sure they are safe and let them know that the trunk is about to open or close.
- Use caution when opening or closing the trunk lid in windy weather as it may move abruptly in strong wind.
- The trunk lid may suddenly shut if it is not opened fully. It is more difficult to open or close the trunk lid on an incline than on a level surface, so beware of the trunk lid unexpectedly opening or closing by itself. Make sure that the trunk lid is fully open and secure before using the trunk.

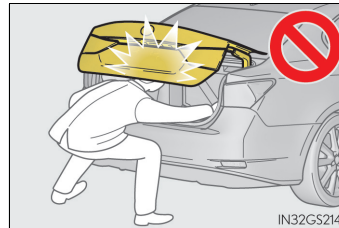

- When closing the trunk lid, take extra care to prevent your fingers etc. from being caught.
- When closing the trunk lid, make sure to press it lightly on its outer surface. If the trunk grip is used to fully close the trunk lid, it may result in hands or arms being caught.

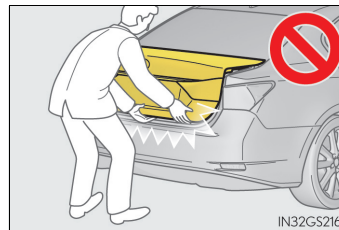

- Do not attach any accessories other than genuine Lexus parts to the trunk lid. Such additional weight on the trunk lid may cause the lid to suddenly shut again after it is opened.

⚠ WARNING

■ **Trunk easy closer**

In the event that the trunk lid is left slightly open, the trunk easy closer will automatically close it to the fully closed position. It takes several seconds before the trunk easy closer begins to operate. Be careful not to catch fingers or anything else in the trunk lid, as this may cause bone fractures or other serious injuries.

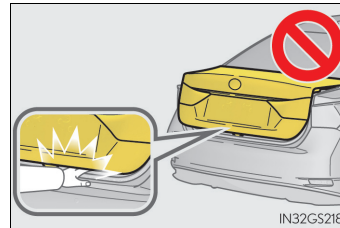

■ **Power trunk lid (if equipped)**

Observe the following precautions when operating the power trunk lid. Failure to do so may cause serious injury.

- Check the safety of the surrounding area to make sure there are no obstacles or anything that could cause any of your belongings to get caught.
- If anyone is in the vicinity, make sure they are safe and let them know that the trunk is about to open or close.
- If the trunk closer switch is pressed while the trunk lid is opening during automatic operation, the trunk lid stops opening. Take extra care when on an incline, as the trunk lid may open or close suddenly.
- On an incline, the trunk lid may suddenly shut after it opens automatically. Make sure the trunk lid is fully open and secure before using the trunk.
- In the following situations, the power trunk lid may detect an abnormality and automatic operation may be stopped. In this case, the trunk lid has to be operated manually. Take extra care in this situation, as the stopped trunk lid may suddenly shut, causing an accident.
 - When the trunk lid contacts an obstacle
 - When the 12-volt battery voltage suddenly drops, such as when the power switch is turned to ON mode or the hybrid system is started during automatic operation
- Do not attach any accessories other than genuine Lexus parts to the trunk lid. The power trunk lid may not operate, causing itself to malfunction, or the trunk lid may suddenly shut again after it is opened.

■ **Jam protection function (vehicles with power trunk lid)**

Observe the following precautions. Failure to do so may cause serious injury.

- Never use any part of your body to intentionally activate the jam protection function.
- The jam protection function may not work if something gets caught just before the trunk lid fully closes. Be careful not to catch fingers or anything else in the trunk lid.
- The jam protection function may not work depending on the shape of the object that is caught. Be careful not to catch fingers or anything else.

 NOTICE**■ To prevent trunk easy closer malfunctions**

Do not apply force to the trunk lid while the trunk easy closer is operating.

■ To prevent damage to the power trunk lid (vehicles with power trunk lid)

- Make sure that there is no luggage or snow on the trunk lid before operating the power trunk lid. In addition, make sure that there is no ice between the trunk lid and frame that prevents movement of the trunk lid. Operating the power trunk lid when excessive load is present on the trunk lid may cause a malfunction.
- Do not apply excessive force to the trunk lid while the power trunk lid is operating.

Smart entry & start system

The following operations can be performed simply by carrying the electronic key (including the card key) on your person, for example in your pocket. The driver should always carry the electronic key.

- Locks and unlocks the doors (vehicles with entry function) (→P. 139)
- Opens the trunk (vehicles with entry function) (→P. 146)
- Starts the hybrid system (→P. 217)

■ Antenna location

- ① Antennas outside the cabin (vehicles with entry function)
- ② Antennas inside the cabin
- ③ Antenna outside the trunk (vehicles with entry function)
- ④ Antenna inside the trunk

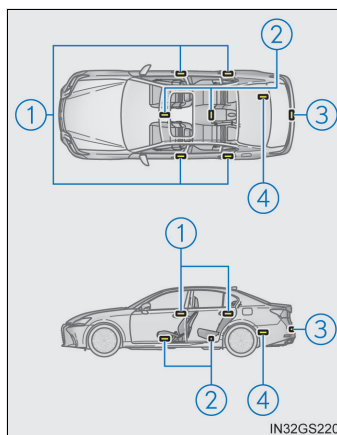

■ Effective range (areas within which the electronic key is detected)

- When locking or unlocking the doors (vehicles with entry function)
The system can be operated when the electronic key is within about 0.7 m (2.3 ft.) of an outside door handle. (Only the doors detecting the key can be operated.)

- When opening the trunk (vehicles with entry function)

The system can be operated when the electronic key is within about 0.7 m (2.3 ft.) of the trunk release button.

- When starting the hybrid system or changing power switch modes

The system can be operated when the electronic key is inside the vehicle.

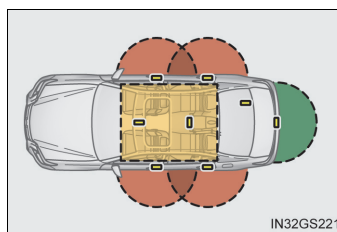

■ Alarms and warning indicators

An alarm sounds and warning message displays shown on the multi-information display are used to protect against unexpected accidents or theft of the vehicle resulting from erroneous operation. When a warning message is displayed, take appropriate measures based on the displayed message. (→P. 493)

When only an alarm sounds, circumstances and correction procedures are as follows.

Alarm	Situation	Correction procedure
Exterior alarm sounds once for 5 seconds	The trunk was closed while the electronic key was still inside the trunk and all the doors were locked.	Retrieve the electronic key from the trunk and close the trunk lid.
	An attempt was made to lock the vehicle while a door was open.	Close all of the doors and lock the doors again.
Interior alarm sounds continuously	The power switch was turned to ACCESSORY mode while the driver's door was open (or the driver's door was opened while the power switch was in ACCESSORY mode).	Turn the power switch off and close the driver's door.



■ Battery-saving function (vehicles with entry function)

The battery-saving function will be activated in order to prevent the electronic key battery and the 12-volt battery from being discharged while the vehicle is not in operation for a long time.

- In the following situations, the smart entry & start system may take some time to unlock the doors.
 - The electronic key has been left in an area of approximately 2 m (6 ft.) of the outside of the vehicle for 10 minutes or longer.
 - The smart entry & start system has not been used for 5 days or longer.
- If the smart entry & start system has not been used for 14 days or longer, the doors cannot be unlocked at any doors except the driver's door. In this case, take hold of the driver's door handle, or use the wireless remote control or the mechanical key, to unlock the doors.

■ Electronic Key Battery-Saving Function

When battery-saving mode is set, battery depletion is minimized by stopping the electronic key from receiving radio waves.

Press  twice while pressing and holding . Confirm that the electronic key indicator flashes 4 times.

While the battery-saving mode is set, the smart entry & start system cannot be used. To cancel the function, press any of the electronic key buttons.

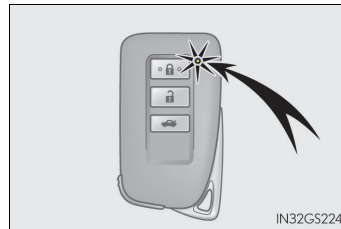

■ Conditions affecting operation

The smart entry & start system uses weak radio waves. In the following situations, the communication between the electronic key and the vehicle may be affected, preventing the smart entry & start system, wireless remote control and immobilizer system from operating properly. (Ways of coping: →P. 527)

- When the electronic key battery is depleted
- Near a TV tower, electric power plant, gas station, radio station, large display, airport or other facility that generates strong radio waves or electrical noise
- When the electronic key is in contact with, or is covered by the following metallic objects
 - Cards to which aluminum foil is attached
 - Cigarette boxes that have aluminum foil inside
 - Metallic wallets or bags
 - Coins
 - Hand warmers made of metal
 - Media such as CDs and DVDs
- When other wireless keys (that emit radio waves) are being used nearby
- When carrying the electronic key together with the following devices that emit radio waves
 - When carrying a portable radio, cellular phone, cordless phone or other wireless communication device
 - Another vehicle's electronic key or a wireless key that emits radio waves
 - Personal computers or personal digital assistants (PDAs)
 - Digital audio players
 - Portable game systems
- If window tint with a metallic content or metallic objects are attached to the rear window
- When the electronic key is placed near a battery charger or electronic devices

■ Note for the entry function (if equipped)

- Even when the electronic key is within the effective range (detection areas), the system may not operate properly in the following cases:
 - The electronic key is too close to the window or outside door handle, near the ground, or in a high place when the doors are locked or unlocked.
 - The electronic key is near the ground or in a high place, or too close to the rear bumper center when the trunk is opened.
 - The electronic key is on the instrument panel, rear package tray or floor, or in the door pockets or glove box when the hybrid system is started or power switch modes are changed.
- Do not leave the electronic key on top of the instrument panel or near the door pockets when exiting the vehicle. Depending on the radio wave reception conditions, it may be detected by the antenna outside the cabin and the door will become lockable from the outside, possibly trapping the electronic key inside the vehicle.
- As long as the electronic key is within the effective range, the doors may be locked or unlocked by anyone. However, only the doors detecting the electronic key can be used to unlock the vehicle.
- The doors may unlock or lock if a large amount of water splashes on the door handle, such as in the rain or in a car wash when the electronic key is within the effective range. (The doors will automatically be locked after approximately 30 seconds if the doors are not opened and closed.)
- If the wireless remote control is used to lock the doors when the electronic key is near the vehicle, there is a possibility that the door may not be unlocked by the entry function. (Use the wireless remote control to unlock the doors.)
- Touching the door lock sensor while wearing gloves may delay or prevent lock operation.
- If the door handle becomes wet while the electronic key is within the effective range, the door may lock and unlock repeatedly. In that case, follow the following correction procedures to wash the vehicle:
 - Place the electronic key in a location 2 m (6 ft.) or more away from the vehicle. (Take care to ensure that the key is not stolen.)
 - Set the electronic key to battery-saving mode to disable the smart entry & start system. (→P. 155)
- If the electronic key is inside the vehicle and a door handle becomes wet during a car wash, a message may be shown on the multi-information display and a buzzer will sound outside the vehicle. To turn off the alarm, lock all the doors.
- The lock sensor may not work properly if it comes into contact with ice, snow, mud, etc. Clean the lock sensor and attempt to operate it again, or use the lock sensor on the lower part of the door handle.
- A sudden approach to the effective range or door handle may prevent the doors from being unlocked. In this case, return the door handle to the original position and check that the doors unlock before pulling the door handle again.
- Gripping the door handle when wearing a glove may not unlock the door.
- If there is another electronic key in the detection area, it may take slightly longer to unlock the doors after the door handle is gripped.
- Fingernails may scrape against the door during operation of the door handle. Be careful not to injure fingernails or damage the surface of the door.

■ Note for the push-start function

- Even when the electronic key is within the effective range (detection areas), the system may not operate properly when the electronic key is on the instrument panel, rear package tray or floor, or in the door pockets or glove box when the hybrid system is started or power switch modes are changed.
- Even if the electronic key is not inside the vehicle, it may be possible to start the hybrid system if the electronic key is near the window.

■ When the vehicle is not driven for extended periods

- Vehicles with entry function: To prevent theft of the vehicle, do not leave the electronic key within 2 m (6 ft.) of the vehicle.
- The smart entry & start system can be deactivated in advance. (→P. 561)

■ To operate the system properly

- Make sure to carry the electronic key when operating the system. Do not get the electronic key too close to the vehicle when operating the system from the outside of the vehicle.

Depending on the position and holding condition of the electronic key, the key may not be detected correctly and the system may not operate properly. (The alarm may go off accidentally, or the door lock prevention function may not operate.)

- Do not leave the electronic key inside the trunk.
The key confinement prevention function may not operate, depending on the location of the key (close to a spare tire [if equipped], the inside edge of the trunk), conditions (inside a metal bag, close to metallic objects) and the radio waves in the surrounding area. (→P. 148)

■ If the smart entry & start system does not operate properly

- Locking and unlocking the doors and opening the trunk: Use the mechanical key. (→P. 527)
- Starting the hybrid system: →P. 528

■ Customization

Settings (e. g. smart entry & start system) can be changed.
(Customizable features: →P. 561)

■ If the smart entry & start system has been deactivated in a customized setting

- Locking and unlocking the doors and opening the trunk:
Use the wireless remote control or mechanical key. (→P. 139, 147, 527)
- Starting the hybrid system and changing power switch modes: →P. 528
- Stopping the hybrid system: →P. 218

■ Certification for the smart entry & start system

<p>Hereby, Tokai Rika Co., Ltd., declares that this BC2EQ is in compliance with the essential requirements and other relevant provisions of Directive 1999/5/EC.</p>
<p>Tokai Rika Co., Ltd. vakuuttaa täten että BC2EQ tyyppinen laite on direktiivin 1999/5/EY oleellisten vaatimusten ja sitä koskevien direktiivin muiden ehtojen mukainen.</p>
<p>Hierbij verklaart Tokai Rika Co., Ltd. dat het toestel BC2EQ in overeenstemming is met de essentiële eisen en de andere relevante bepalingen van richtlijn 1999/5/EG.</p>
<p>Par la présente Tokai Rika Co., Ltd. déclare que l'appareil BC2EQ est conforme aux exigences essentielles et aux autres dispositions pertinentes de la directive 1999/5/CE.</p>
<p>Härmed intygar Tokai Rika Co., Ltd. att denna BC2EQ står i överensstämmelse med de väsentliga egenskapskrav och övriga relevanta bestämmelser som framgår av direktiv 1999/5/EG.</p>
<p>Undertegnede Tokai Rika Co., Ltd. erklærer herved, at følgende udstyr BC2EQ overholder de væsentlige krav og øvrige relevante krav i direktiv 1999/5/EF.</p>
<p>Hiermit erklärt Tokai Rika Co., Ltd., dass sich das Gerät BC2EQ in Übereinstimmung mit den grundlegenden Anforderungen und den übrigen einschlägigen Bestimmungen der Richtlinie 1999/5/EG befindet.</p>
<p>ΜΕ ΤΗΝ ΠΑΡΟΥΣΑ Tokai Rika Co., Ltd. ΔΗΛΩΝΕΙ ΟΤΙ BC2EQ ΣΥΜΜΟΡΦΩΝΕΤΑΙ ΠΡΟΣ ΤΙΣ ΟΥΣΙΩΔΕΙΣ ΑΠΑΙΤΗΣΕΙΣ ΚΑΙ ΤΙΣ ΛΟΙΠΕΣ ΣΧΕΤΙΚΕΣ ΔΙΑΤΑΞΕΙΣ ΤΗΣ ΟΔΗΓΙΑΣ 1999/5/ΕΚ.</p>
<p>Con la presente Tokai Rika Co., Ltd. dichiara che questo BC2EQ è conforme ai requisiti essenziali ed alle altre disposizioni pertinenti stabilite dalla direttiva 1999/5/CE.</p>
<p>Por medio de la presente Tokai Rika Co., Ltd. declara que el BC2EQ cumple con los requisitos esenciales y cualesquiera otras disposiciones aplicables o exigibles de la Directiva 1999/5/CE.</p>
<p>Tokai Rika Co., Ltd. declara que este BC2EQ está conforme com os requisitos essenciais e outras disposições da Directiva 1999/5/CE.</p>
<p>Hawnhekk, Tokai Rika Co., Ltd., jiddikjara li dan BC2EQ jikkonforma mal-ftigijiet essenzjali u ma provvedimenti oħrajn relevanti li hemm fid-Dirrettiva 1999/5/EC.</p>
<p>Käesolevaga kinnitab Tokai Rika Co., Ltd. seadme BC2EQ vastavust direktiivi 1999/5/EÜ põhinõuetele ja nimetatud direktiivist tulenevatele teistele asjakohastele sätetele.</p>

Alulírott, Tokai Rika Co., Ltd. nyilatkozom, hogy a BC2EQ megfelel a vonatkozó alapvető követelményeknek és az 1999/5/EC irányelv egyéb előírásainak.
Tokai Rika Co., Ltd. tímto vyhlasuje, že BC2EQ spĺňa základné požiadavky a všetky príslušné ustanovenia Smernice 1999/5/ES.
Tokai Rika Co., Ltd. tímto prohlašuje, že tento BC2EQ je ve shodě se základními požadavky a dalšími příslušnými ustanoveními směrnice 1999/5/ES.
Tokai Rika Co., Ltd. izjavlja, da je ta BC2EQ v skladu z bistvenimi zahtevami in ostalimi relevantnimi določili direktive 1999/5/ES.
Šiuo Tokai Rika Co., Ltd. deklaruoja, kad šis BC2EQ atitinka esminius reikalavimus ir kitas 1999/5/EB Direktyvos nuostatas.
Ar šo Tokai Rika Co., Ltd. deklarē, ka BC2EQ atbilst Direktīvas 1999/5/EK būtiskajām prasībām un citiem ar to saistītajiem noteikumiem.
Niniejszym Tokai Rika Co., Ltd. oświadcza, że BC2EQ jest zgodny z zasadniczymi wymogami oraz pozostałymi stosownymi postanowieniami Dyrektywy 1999/5/EC.
Hér með lýsir Tokai Rika Co., Ltd. yfir því að BC2EQ er í samræmi við grunnkröfur og aðrar kröfur, sem gerðar eru í tilskipun 1999/5/EC.
Tokai Rika Co., Ltd. erklærer herved at utstyret BC2EQ er i samsvar med de grunnleggende krav og øvrige relevante krav i direktiv 1999/5/EF.
С настоящето, Tokai Rika Co., Ltd., декларира, че BC2EQ е в съответствие със съществените изисквания и другите приложими разпоредби на Директива 1999/5/EC.
Prin prezenta, Tokai Rika Co., Ltd., declară că aparatul BC2EQ este în conformitate cu cerințele esențiale și cu alte prevederi pertinente ale Directivei 1999/5/CE.
Ovim, Tokai Rika Co., Ltd., izjavljuje da ovaj BC2EQ je usklađen sa bitnim zahtjevima i drugim relevantnim odredbama Direktive 1999/5/EC.
Nepermjet kesaj, Tokai Rika Co., Ltd., deklaroi qe ky BC2EQ eshte ne pajtim me kerkesat thelbesore dhe dispozitat e tjera perkatese te Direktives 1999/5/EC.
Ovim Tokai Rika Co., Ltd., izjavljuje da je BC2EQ u skladu s bitnim zahtjevima i drugim relevantnim odredbama Direktive 1999/5/EC i Pravilnika o RiTT opremi (NN 25/2012).
Ovim, Tokai Rika Co., Ltd., deklarirše da je BC2EQ u skladu sa osnovnim zahtevima i ostalim relevantnim odredbama Direktive 1999/5/EC.
İşbu belge ile Tokai Rika Co., Ltd., bu BC2EQ ürününün 1999/5/EC Yönetmeliği'nin temel gerekliliklerine ve diğer ilgili hükümlerine uygun olduğunu beyan eder.

The DECLARATION of CONFORMITY (DoC) is available at the following address:
<http://www.tokai-rika.co.jp/pc>



TOKAI RIKA

R&TTE Declaration of Conformity

We,

Manufacturer's Name: Tokai Rika Co., Ltd.

Manufacturer's Address: 260, Toyota 3-chome, Oguchi-cho, Niwa-gun, Aichi-ken,
480-0195, Japan

hereby declare under our sole responsibility that the product:

Product Name: Electronic Key

Product Model: BC2EQ

to which this declaration relates is in conformity with the essential requirements and other relevant requirements of the R&TTE Directive (1999/5/EC). The product is compliant with the following standards and/or other normative documents:

Safety: EN60950-1

EMC: EN301 489-1 & -3

Spectrum: EN300 220-2, EN300 330-2

Supplementary information:

* CE mark	
* Member states intended for use	EU and EFTA
* Member states with restrictive use	None

Date:

June 1, 2012

Signature:

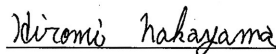

Position of the signatory:

Hiromi Nakayama
General Manager,
Electronics Quality Control Div.

3

Operation of each component

Hereby, Tokai Rika Co., Ltd., declares that this BA2KP is in compliance with the essential requirements and other relevant provisions of Directive 1999/5/EC.
Tokai Rika Co., Ltd. vakuuttaa täten että BA2KP tyyppinen laite on direktiivin 1999/5/EY oleellisten vaatimusten ja sitä koskevien direktiivin muiden ehtojen mukainen.
Hierbij verklaart Tokai Rika Co., Ltd. dat het toestel BA2KP in overeenstemming is met de essentiële eisen en de andere relevante bepalingen van richtlijn 1999/5/EG.
Par la présente Tokai Rika Co., Ltd. déclare que l'appareil BA2KP est conforme aux exigences essentielles et aux autres dispositions pertinentes de la directive 1999/5/CE.
Härmed intygar Tokai Rika Co., Ltd. att denna BA2KP står i överensstämmelse med de väsentliga egenskapskrav och övriga relevanta bestämmelser som framgår av direktiv 1999/5/EG.
Undertegnede Tokai Rika Co., Ltd. erklærer herved, at følgende udstyr BA2KP overholder de væsentlige krav og øvrige relevante krav i direktiv 1999/5/EF.
Hiermit erklärt Tokai Rika Co., Ltd., dass sich das Gerät BA2KP in Übereinstimmung mit den grundlegenden Anforderungen und den übrigen einschlägigen Bestimmungen der Richtlinie 1999/5/EG befindet.
ΜΕ ΤΗΝ ΠΑΡΟΥΣΑ Tokai Rika Co., Ltd. ΔΗΛΩΝΕΙ ΟΤΙ ΒΑ2ΚΡ ΣΥΜΜΟΡΦΩΝΕΤΑΙ ΠΡΟΣ ΤΙΣ ΟΥΣΙΩΔΕΙΣ ΑΠΑΙΤΗΣΕΙΣ ΚΑΙ ΤΙΣ ΛΟΙΠΕΣ ΣΧΕΤΙΚΕΣ ΔΙΑΤΑΞΕΙΣ ΤΗΣ ΟΔΗΓΙΑΣ 1999/5/ΕΚ.
Con la presente Tokai Rika Co., Ltd. dichiara che questo BA2KP è conforme ai requisiti essenziali ed alle altre disposizioni pertinenti stabilite dalla direttiva 1999/5/CE.
Por medio de la presente Tokai Rika Co., Ltd. declara que el BA2KP cumple con los requisitos esenciales y cualesquiera otras disposiciones aplicables o exigibles de la Directiva 1999/5/CE.
Tokai Rika Co., Ltd. declara que este BA2KP está conforme com os requisitos essenciais e outras disposições da Directiva 1999/5/CE.
Hawnhekk, Tokai Rika Co., Ltd., jiddikjara li dan BA2KP jikkonforma mal-htigijiet essenzjali u ma provvedimenti oħrajn rilevanti li hemm fid-Dirrettiva 1999/5/EC.
Käesolevaga kinnitab Tokai Rika Co., Ltd. seadme BA2KP vastavust direktiivi 1999/5/EÜ põhinõuetele ja nimetatud direktiivist tulenevatele teistele asjakohastele sätetele.
Alulírott, Tokai Rika Co., Ltd. nyilatkozom, hogy a BA2KP megfelel a vonatkozó alapvető követelményeknek és az 1999/5/EC irányelv egyéb előírásainak.

Tokai Rika Co., Ltd. tímto vyhlasuje, že BA2KP spĺňa základné požiadavky a všetky príslušné ustanovenia Smernice 1999/5/ES.
Tokai Rika Co., Ltd. tímto prohlašuje, že tento BA2KP je ve shodě se základními požadavky a dalšími příslušnými ustanoveními směrnice 1999/5/ES.
Tokai Rika Co., Ltd. izjavlja, da je ta BA2KP v skladu z bistvenimi zahtevami in ostalimi relevantnimi določili direktive 1999/5/ES.
Šiuo Tokai Rika Co., Ltd. deklaruoja, kad šis BA2KP atitinka esminius reikalavimus ir kitas 1999/5/EB Direktyvos nuostatas.
Ar šo Tokai Rika Co., Ltd. deklarē, ka BA2KP atbilst Direktīvas 1999/5/EK būtiskajām prasībām un citiem ar to saistītajiem noteikumiem.
Niniejszym Tokai Rika Co., Ltd. oświadcza, że BA2KP jest zgodny z zasadniczymi wymogami oraz pozostałymi stosownymi postanowieniami Dyrektywy 1999/5/EC.
Hér með lýsir Tokai Rika Co., Ltd. yfir því að BA2KP er í samræmi við grunnkröfur og aðrar kröfur, sem gerðar eru í tilskipun 1999/5/EC.
Tokai Rika Co., Ltd. erklærer herved at utstyret BA2KP er i samsvar med de grunnleggende krav og øvrige relevante krav i direktiv 1999/5/EF.
С настоящето, Tokai Rika Co., Ltd., декларира, че BA2KP е в съответствие със съществените изисквания и другите приложими разпоредби на Директива 1999/5/EC.
Prin prezenta, Tokai Rika Co., Ltd., declară că aparatul BA2KP este în conformitate cu cerințele esențiale și cu alte prevederi pertinente ale Directivei 1999/5/CE.
Ovim, Tokai Rika Co., Ltd., izjavljuje da ovaj BA2KP je usklađen sa bitnim zahtjevima i drugim relevantnim odredbama Direktive 1999/5/EC.
Nepermjet kesaj, Tokai Rika Co., Ltd., deklaroj qe ky BA2KP eshte ne pajtim me kerkesat thelbesore dhe dispozitat e tjera perkatese te Direktives 1999/5/EC.
Ovim Tokai Rika Co., Ltd., izjavljuje da je BA2KP u skladu s bitnim zahtjevima i drugim relevantnim odredbama Direktive 1999/5/EC i Pravilnika o RiTT opremi (NN 25/2012).
Ovim, Tokai Rika Co., Ltd., deklarirše da je BA2KP u skladu sa osnovnim zahtevima i ostalim relevantnim odredbama Direktive 1999/5/EC.
İşbu belge ile Tokai Rika Co., Ltd., bu BA2KP ürününün 1999/5/EC Yönetmeliği'nin temel gerekliliklerine ve diğer ilgili hükümlerine uygun olduğunu beyan eder.

The DECLARATION of CONFORMITY (DoC) is available at the following address:
<http://www.tokai-rika.co.jp/pc>



TOKAI RIKAOGUCHI-CHO, NIWA-GUN
AICHI-KEN, 480-0195 JAPAN
TEL: +81-587-95-0093
FAX: +81-587-95-5471**R&TTE Declaration of Conformity**

We,

Manufacturer's Name: Tokai Rika Co., Ltd.

Manufacturer's Address: 260, Toyota 3-chome, Oguchi-cho, Niwa-gun, Aichi-ken,
480-0195, Japan

hereby declare under our sole responsibility that the product:

Product Name: Receiver

Product Model: BA2KP

to which this declaration relates is in conformity with the essential requirements and other relevant requirements of the R&TTE Directive (1999/5/EC). The product is compliant with the following standards and/or other normative documents:

Safety: EN60950-1:2006

EMC: EN301 489-1 V1.9.2 & EN301 489-3 V1.4.1

Spectrum: EN300 220-2 V2.4.1

Supplementary information:

* CE mark	
* Member states intended for use	EU and EFTA
* Member states with restrictive use	None

Date: January 24, 2013Signature: Makoto OkadaPosition of the signatory: Makoto Okada
Project General Manager,
Electronics Quality Control Div.

3

Operation of each component

Hereby, TOYOTA MOTOR CORPORATION, declares that this TMLF10-3 is in compliance with the essential requirements and other relevant provisions of Directive 1999/5/EC.
TOYOTA MOTOR CORPORATION vakuuttaa täten että TMLF10-3 tyyppinen laite on direktiivin 1999/5/EY oleellisten vaatimusten ja sitä koskevien direktiivin muiden ehtojen mukainen.
Hierbij verklaart TOYOTA MOTOR CORPORATION dat het toestel TMLF10-3 in overeenstemming is met de essentiële eisen en de andere relevante bepalingen van richtlijn 1999/5/EG.
Par la présente TOYOTA MOTOR CORPORATION déclare que l'appareil TMLF10-3 est conforme aux exigences essentielles et aux autres dispositions pertinentes de la directive 1999/5/CE.
Härmed intygar TOYOTA MOTOR CORPORATION att denna TMLF10-3 står i överensstämmelse med de väsentliga egenskapskrav och övriga relevanta bestämmelser som framgår av direktiv 1999/5/EG.
Undertegnede TOYOTA MOTOR CORPORATION erklærer herved, at følgende udstyr TMLF10-3 overholder de væsentlige krav og øvrige relevante krav i direktiv 1999/5/EF.
Hiermit erklärt TOYOTA MOTOR CORPORATION, dass sich das Gerät TMLF10-3 in Übereinstimmung mit den grundlegenden Anforderungen und den übrigen einschlägigen Bestimmungen der Richtlinie 1999/5/EG befindet.
ΜΕ ΤΗΝ ΠΑΡΟΥΣΑ ΤΟΥΟΤΑ ΜΟΤΟΡ ΚΟΡΠΟΡΑΤΙΟΝ ΔΗΛΩΝΕΙ ΟΤΙ ΤΜΛΦ10-3 ΣΥΜΜΟΡΦΩΝΕΤΑΙ ΠΡΟΣ ΤΙΣ ΟΥΣΙΩΔΕΙΣ ΑΠΑΙΤΗΣΕΙΣ ΚΑΙ ΤΙΣ ΛΟΙΠΕΣ ΣΧΕΤΙΚΕΣ ΔΙΑΤΑΞΕΙΣ ΤΗΣ ΟΔΗΓΙΑΣ 1999/5/ΕΚ.
Con la presente TOYOTA MOTOR CORPORATION dichiara che questo TMLF10-3 è conforme ai requisiti essenziali ed alle altre disposizioni pertinenti stabilite dalla direttiva 1999/5/CE.
Por medio de la presente TOYOTA MOTOR CORPORATION declara que el TMLF10-3 cumple con los requisitos esenciales y cualesquiera otras disposiciones aplicables o exigibles de la Directiva 1999/5/CE.
TOYOTA MOTOR CORPORATION declara que este TMLF10-3 está conforme com os requisitos essenciais e outras disposições da Directiva 1999/5/CE.
Hawnhekk, TOYOTA MOTOR CORPORATION, jiddikjara li dan TMLF10-3 jikkonforma mal-ħtiġijiet essenzjali u ma provvedimenti oħrajn relevanti li hemm fid-Dirrettiva 1999/5/EC.
Käesolevaga kinnitab TOYOTA MOTOR CORPORATION seadme TMLF10-3 vastavust direktiivi 1999/5/EÜ põhinõuetele ja nimetatud direktiivist tulenevatele teistele asjakohastele sätetele.
Alulírott, TOYOTA MOTOR CORPORATION nyilatkozom, hogy a TMLF10-3 megfelel a vonatkozó alapvető követelményeknek és az 1999/5/EC irányelv egyéb előírásainak.
TOYOTA MOTOR CORPORATION týmto vyhlasuje, že TMLF10-3 spĺňa základné požiadavky a všetky príslušné ustanovenia Smernice 1999/5/ES.

TOYOTA MOTOR CORPORATION tímto prohlašuje, že tento TMLF10-3 je ve shodě se základními požadavky a dalšími příslušnými ustanoveními směrnice 1999/5/ES.
TOYOTA MOTOR CORPORATION izjavlja, da je ta TMLF10-3 v skladu z bistvenimi zahtevami in ostalimi relevantnimi določili direktive 1999/5/ES.
Šiuo TOYOTA MOTOR CORPORATION deklaruoja, kad šis TMLF10-3 atitinka esminius reikalavimus ir kitas 1999/5/EB Direktyvos nuostatas.
Ar šo TOYOTA MOTOR CORPORATION deklarē, ka TMLF10-3 atbilst Direktīvas 1999/5/EK būtiskajām prasībām un citiem ar to saistītajiem noteikumiem.
Niniejszym TOYOTA MOTOR CORPORATION oświadcza, że TMLF10-3 jest zgodny z zasadniczymi wymogami oraz pozostałymi stosownymi postanowieniami Dyrektywy 1999/5/EC.
Hér með lýsir TOYOTA MOTOR CORPORATION yfir því að TMLF10-3 er í samræmi við grunnkröfur og aðrar kröfur, sem gerðar eru í tilskipun 1999/5/EC.
TOYOTA MOTOR CORPORATION erklærer herved at utstyret TMLF10-3 er i samsvar med de grunnleggende krav og øvrige relevante krav i direktiv 1999/5/EF.
С настоящето, TOYOTA MOTOR CORPORATION, декларира, че TMLF10-3 е в съответствие със съществените изисквания и другите приложими разпоредби на Директива 1999/5/EC.
Prin prezenta, TOYOTA MOTOR CORPORATION, declară că aparatul TMLF10-3 este în conformitate cu cerințele esențiale și cu alte prevederi pertinente ale Directivei 1999/5/CE.
Ovim, TOYOTA MOTOR CORPORATION, izjavljuje da ovaj TMLF10-3 je usklađen sa bitnim zahtjevima i drugim relevantnim odredbama Direktive 1999/5/EC.
Nepermjet kesaj, TOYOTA MOTOR CORPORATION, deklaroi qe ky TMLF10-3 eshte ne pajtim me kerkesat thelbesore dhe dispozitat e tjera perkatese te Direktives 1999/5/EC.
Ovim TOYOTA MOTOR CORPORATION, izjavljuje da je TMLF10-3 u skladu s bitnim zahtjevima i drugim relevantnim odredbama Direktive 1999/5/EC i Pravilnika o RiTT opremi (NN 25/2012).
Ovim, TOYOTA MOTOR CORPORATION, deklarirše da je TMLF10-3 u skladu sa osnovnim zahtevima i ostalim relevantnim odredbama Direktive 1999/5/EC.
İşbu belge ile TOYOTA MOTOR CORPORATION, bu TMLF10-3 ürününün 1999/5/EC Yönetmeliği'nin temel gerekliliklerine ve diğer ilgili hükümlerine uygun olduğunu beyan eder.

TOYOTA

TOYOTA MOTOR CORPORATION

1, TOYOTA-CHO, TOYOTA, AICHI, 471-8571, JAPAN TEL: +81-565-28-2121

R&TTE Declaration of Conformity

We,

Manufacturer's Name: TOYOTA MOTOR CORPORATION
 Manufacturer's Address: 1, Toyota -cho, Toyota, Aichi, 471-8572, Japan

hereby declare under our sole responsibility that the product:

Product Name: LF Oscillator
 Product Model: TMLF10-3 ✓

to which this declaration relates is in conformity with the essential requirements and other relevant requirements of the R&TTE Directive (1999/5/EC). The product is compliant with the following standards and/or other normative documents:

-Health & safety requirements: EN 60950-1
 -EMC requirements: EN 301 489-01 & EN 301 489-03
 -Effective uses of radio spectrum: EN 300 330-2

Supplementary information:

* CE mark	
* Member states intended for use	EU and EFTA

Date: February 25, 2013

Signature: 
 Tetsuya Matsuo

<p>Hereby, TOYOTA MOTOR CORPORATION, declares that this TMLF10-51 is in compliance with the essential requirements and other relevant provisions of Directive 1999/5/EC.</p>
<p>TOYOTA MOTOR CORPORATION vakuuttaa täten että TMLF10-51 tyyppinen laite on direktiivin 1999/5/EY oleellisten vaatimusten ja sitä koskevien direktiivin muiden ehtojen mukainen.</p>
<p>Hierbij verklaart TOYOTA MOTOR CORPORATION dat het toestel TMLF10-51 in overeenstemming is met de essentiële eisen en de andere relevante bepalingen van richtlijn 1999/5/EG.</p>
<p>Par la présente TOYOTA MOTOR CORPORATION déclare que l'appareil TMLF10-51 est conforme aux exigences essentielles et aux autres dispositions pertinentes de la directive 1999/5/CE.</p>
<p>Härmed intygar TOYOTA MOTOR CORPORATION att denna TMLF10-51 står i överensstämmelse med de väsentliga egenskapskrav och övriga relevanta bestämmelser som framgår av direktiv 1999/5/EG.</p>
<p>Undertegnede TOYOTA MOTOR CORPORATION erklærer herved, at følgende udstyr TMLF10-51 overholder de væsentlige krav og øvrige relevante krav i direktiv 1999/5/EF.</p>
<p>Hiermit erkläre TOYOTA MOTOR CORPORATION, dass sich das Gerät TMLF10-51 in Übereinstimmung mit den grundlegenden Anforderungen und den übrigen einschlägigen Bestimmungen der Richtlinie 1999/5/EG befindet.</p>
<p>ΜΕ ΤΗΝ ΠΑΡΟΥΣΑ ΤΟΥΤΑ ΜΟΤΟΡ ΚΟΡΠΟΡΑΤΙΟΝ ΔΗΛΩΝΕΙ ΟΤΙ ΤΜΛΦ10-51 ΣΥΜΜΟΡΦΩΝΕΤΑΙ ΠΡΟΣ ΤΙΣ ΟΥΣΙΩΔΕΙΣ ΑΠΑΙΤΗΣΕΙΣ ΚΑΙ ΤΙΣ ΛΟΙΠΕΣ ΣΧΕΤΙΚΕΣ ΔΙΑΤΑΞΕΙΣ ΤΗΣ ΟΔΗΓΙΑΣ 1999/5/ΕΚ.</p>
<p>Con la presente TOYOTA MOTOR CORPORATION dichiara che questo TMLF10-51 è conforme ai requisiti essenziali ed alle altre disposizioni pertinenti stabilite dalla direttiva 1999/5/CE.</p>
<p>Por medio de la presente TOYOTA MOTOR CORPORATION declara que el TMLF10-51 cumple con los requisitos esenciales y cualesquiera otras disposiciones aplicables o exigibles de la Directiva 1999/5/CE.</p>
<p>TOYOTA MOTOR CORPORATION declara que este TMLF10-51 está conforme com os requisitos essenciais e outras disposições da Directiva 1999/5/CE.</p>
<p>Hawnhekk, TOYOTA MOTOR CORPORATION, jiddikjara li dan TMLF10-51 jikkonforma mal-htigijiet essenzjali u ma provvedimenti oħrajn rilevanti li hemm fid-Dirrettiva 1999/5/EC.</p>
<p>Käesolevaga kinnitab TOYOTA MOTOR CORPORATION seadme TMLF10-51 vastavust direktiivi 1999/5/EÜ põhinõuetele ja nimetatud direktiivist tulenevatele teistele asjakohastele sätetele.</p>
<p>Alulírott, TOYOTA MOTOR CORPORATION nyilatkozom, hogy a TMLF10-51 megfelel a vonatkozó alapvető követelményeknek és az 1999/5/EC irányelv egyéb előírásainak.</p>

TOYOTA MOTOR CORPORATION tímto vyhlasuje, že TMLF10-51 splňa základné požiadavky a všetky príslušné ustanovenia Smernice 1999/5/ES.
TOYOTA MOTOR CORPORATION tímto prohlašuje, že tento TMLF10-51 je ve shodě se základními požadavky a dalšími příslušnými ustanoveními směrnice 1999/5/ES.
TOYOTA MOTOR CORPORATION izjavlja, da je ta TMLF10-51 v skladu z bistvenimi zahtevami in ostalimi relevantnimi določili direktive 1999/5/ES.
Šiuo TOYOTA MOTOR CORPORATION deklaruoja, kad šis TMLF10-51 atitinka esminius reikalavimus ir kitas 1999/5/EB Direktyvos nuostatas.
Ar šo TOYOTA MOTOR CORPORATION deklarē, ka TMLF10-51 atbilst Direktīvas 1999/5/EK būtiskajām prasībām un citiem ar to saistītajiem noteikumiem.
Niniejszym TOYOTA MOTOR CORPORATION oświadcza, że TMLF10-51 jest zgodny z zasadniczymi wymogami oraz pozostałymi stosownymi postanowieniami Dyrektywy 1999/5/EC.
Hér með lýsir TOYOTA MOTOR CORPORATION yfir því að TMLF10-51 er í samræmi við grunnkröfur og aðrar kröfur, sem gerðar eru í tilskipun 1999/5/EC.
TOYOTA MOTOR CORPORATION erklærer herved at utstyret TMLF10-51 er i samsvar med de grunnleggende krav og øvrige relevante krav i direktiv 1999/5/EF.
С настоящето, TOYOTA MOTOR CORPORATION, декларира, че TMLF10-51 е в съответствие със съществените изисквания и другите приложими разпоредби на Директива 1999/5/EC.
Prin prezenta, TOYOTA MOTOR CORPORATION, declară că aparatul TMLF10-51 este în conformitate cu cerințele esențiale și cu alte prevederi pertinente ale Directivei 1999/5/CE.
Ovim, TOYOTA MOTOR CORPORATION, izjavljuje da ovaj TMLF10-51 je usklađen sa bitnim zahtjevima i drugim relevantnim odredbama Direktive 1999/5/EC.
Nepermjet kesaj, TOYOTA MOTOR CORPORATION, deklaruj qe ky TMLF10-51 eshte ne pajtim me kerkesat thelbesore dhe dispozitat e tjera perkatese te Direktives 1999/5/EC.
Ovim TOYOTA MOTOR CORPORATION, izjavljuje da je TMLF10-51 u skladu s bitnim zahtjevima i drugim relevantnim odredbama Direktive 1999/5/EC i Pravilnika o RiTT opremi (NN 25/2012).
Ovim, TOYOTA MOTOR CORPORATION, deklarise da je TMLF10-51 u skladu sa osnovnim zahtevima i ostalim relevantnim odredbama Direktive 1999/5/EC.
İşbu belge ile TOYOTA MOTOR CORPORATION, bu TMLF10-51 ürününün 1999/5/EC Yönetmeliği'nin temel gerekliliklerine ve diğer ilgili hükümlerine uygun olduğunu beyan eder.

TOYOTA

TOYOTA MOTOR CORPORATION

1, TOYOTA-CHO, TOYOTA, AICHI, 471-8571, JAPAN TEL: +81-565-28-2121

R&TTE Declaration of Conformity

We,

Manufacturer's Name: TOYOTA MOTOR CORPORATION

Manufacturer's Address: 1, Toyota -cho, Toyota, Aichi, 471-8572, Japan

hereby declare under our sole responsibility that the product:

Product Name: LF Oscillator

Product Model: TMLF10-51 ✓

to which this declaration relates is in conformity with the essential requirements and other relevant requirements of the R&TTE Directive (1999/5/EC). The product is compliant with the following standards and/or other normative documents:

-Health & safety requirements:	EN 60950-1
-EMC requirements	EN 301 489-01 & EN 301 489-03
-Effective uses of radio spectrum:	EN 300 330-2

Supplementary information:

* CE mark	
* Member states intended for use	EU and EFTA

Date: January 9, 2013

Signature:

Tetsuya Matsuo

3

Operation of each component

Hereby, DENSO CORPORATION declares that this 14CCA is in compliance with the essential requirements and other relevant provisions of Directive 1999/5/EC.
DENSO CORPORATION vakuuttaa täten että 14CCA tyyppinen laite on direktiivin 1999/5/EY oleellisten vaatimusten ja sitä koskevien direktiivin muiden ehtojen mukainen.
Hierbij verklaart DENSO CORPORATION dat het toestel 14CCA in overeenstemming is met de essentiële eisen en de andere relevante bepalingen van richtlijn 1999/5/EG.
Par la présente DENSO CORPORATION déclare que l'appareil 14CCA est conforme aux exigences essentielles et aux autres dispositions pertinentes de la directive 1999/5/CE.
Härmed intygar DENSO CORPORATION att denna 14CCA står i överensstämmelse med de väsentliga egenskapskrav och övriga relevanta bestämmelser som framgår av direktiv 1999/5/EG.
Undertegnede DENSO CORPORATION erklærer herved, at følgende udstyr 14CCA overholder de væsentlige krav og øvrige relevante krav i direktiv 1999/5/EF.
Hiermit erklärt DENSO CORPORATION, dass sich das Gerät 14CCA in Übereinstimmung mit den grundlegenden Anforderungen und den übrigen einschlägigen Bestimmungen der Richtlinie 1999/5/EG befindet.
ΜΕ ΤΗΝ ΠΑΡΟΥΣΑ DENSO CORPORATION ΔΗΛΩΝΕΙ ΟΤΙ 14CCA ΣΥΜΜΟΡΦΩΝΕΤΑΙ ΠΡΟΣ ΤΙΣ ΟΥΣΙΩΔΕΙΣ ΑΠΑΙΤΗΣΕΙΣ ΚΑΙ ΤΙΣ ΛΟΙΠΕΣ ΣΧΕΤΙΚΕΣ ΔΙΑΤΑΞΕΙΣ ΤΗΣ ΟΔΗΓΙΑΣ 1999/5/EK.
Con la presente DENSO CORPORATION dichiara che questo 14CCA è conforme ai requisiti essenziali ed alle altre disposizioni pertinenti stabilite dalla direttiva 1999/5/CE.
Por medio de la presente DENSO CORPORATION declara que el 14CCA cumple con los requisitos esenciales y cualesquiera otras disposiciones aplicables o exigibles de la Directiva 1999/5/CE.
DENSO CORPORATION declara que este 14CCA está conforme com os requisitos essenciais e outras disposições da Directiva 1999/5/CE.
Hawnhekk, DENSO CORPORATION, jiddikjara li dan 14CCA jikkonforma mal-ħtiġijiet essenzjali u ma provvedimenti oħrajn relevanti li hemm fid-Dirrettiva 1999/5/EC.
Käesolevaga kinnitab DENSO CORPORATION seadme 14CCA vastavust direktiivi 1999/5/EÜ põhinõuetele ja nimetatud direktiivist tulenevatele teistele asjakohastele sätetele.
Alulírott, DENSO CORPORATION nyilatkozom, hogy a 14CCA megfelel a vonatkozó alapvető követelményeknek és az 1999/5/EC irányelv egyéb előírásainak.

DENSO CORPORATION tímto vyhlasuje, že 14CCA spĺňa základné požiadavky a všetky príslušné ustanovenia Smernice 1999/5/ES.
DENSO CORPORATION tímto prohlašuje, že tento 14CCA je ve shodě se základními požadavky a dalšími příslušnými ustanoveními směrnice 1999/5/ES.
DENSO CORPORATION izjavlja, da je ta 14CCA v skladu z bistvenimi zahtevami in ostalimi relevantnimi določili direktive 1999/5/ES.
Šiuo DENSO CORPORATION deklaruoja, kad šis 14CCA atitinka esminius reikalavimus ir kitas 1999/5/EB Direktyvos nuostatas.
Ar šo DENSO CORPORATION deklarē, ka 14CCA atbilst Direktīvas 1999/5/EK būtiskajām prasībām un citiem ar to saistītajiem noteikumiem.
Niniejszym DENSO CORPORATION oświadcza, że 14CCA jest zgodny z zasadniczymi wymogami oraz pozostałymi stosownymi postanowieniami Dyrektywy 1999/5/EC.
Hér með lýsir DENSO CORPORATION yfir því að 14CCA er í samræmi við grunnkröfur og aðrar kröfur, sem gerðar eru í tilskipun 1999/5/EC.
DENSO CORPORATION erklærer herved at utstyret 14CCA er i samsvar med de grunnleggende krav og øvrige relevante krav i direktiv 1999/5/EF.
С настоящето, DENSO CORPORATION, декларира, че 14CCA е в съответствие със съществениите изисквания и другите приложими разпоредби на Директива 1999/5/EC.
Prin prezenta, DENSO CORPORATION, declară că aparatul 14CCA este în conformitate cu cerințele esențiale și cu alte prevederi pertinente ale Directivei 1999/5/CE.
Ovim, DENSO CORPORATION, izjavljuje da ovaj 14CCA je usklađen sa bitnim zahtjevima i drugim relevantnim odredbama Direktive 1999/5/EC.
Ovim, DENSO CORPORATION, deklarirše da je 14CCA u skladu sa osnovnim zahtjevima i ostalim relevantnim odredbama Direktive 1999/5/EC.
Ovim DENSO CORPORATION, izjavljuje da je 14CCA u skladu s bitnim zahtjevima i drugim relevantnim odredbama Direktive 1999/5/EC i Pravilnika o RiTT opremi (NN 25/2012).
Nepermjet kesaj, DENSO CORPORATION, deklaror qe ky 14CCA eshte ne pajtim me kerkesat thelbesore dhe dispozitat e tjera perkatese te Direktives 1999/5/EC.



The latest "DECLARATION of CONFORMITY" (DoC) is available at the following address:
<http://www.globaldenso.com/en/products/oem/index.html>

 **WARNING**

■ **Caution regarding interference with electronic devices**

- People with implantable cardiac pacemakers, cardiac resynchronization therapy-pacemakers or implantable cardioverter defibrillators should maintain a reasonable distance between themselves and the smart entry & start system antennas. (→P. 153)
The radio waves may affect the operation of such devices. If necessary, the entry function can be disabled. Ask any authorized Lexus retailer or Lexus authorized repairer, or any reliable repairer for details, such as the frequency of radio waves and timing of the emitted radio waves. Then, consult your doctor to see if you should disable the entry function.
- Users of any electrical medical device other than implantable cardiac pacemakers, cardiac resynchronization therapy-pacemakers or implantable cardioverter defibrillators should consult the manufacturer of the device for information about its operation under the influence of radio waves.
Radio waves could have unexpected effects on the operation of such medical devices.

Ask any authorized Lexus retailer or Lexus authorized repairer, or any reliable repairer for details on disabling the entry function.

Front seats

Adjustment procedure

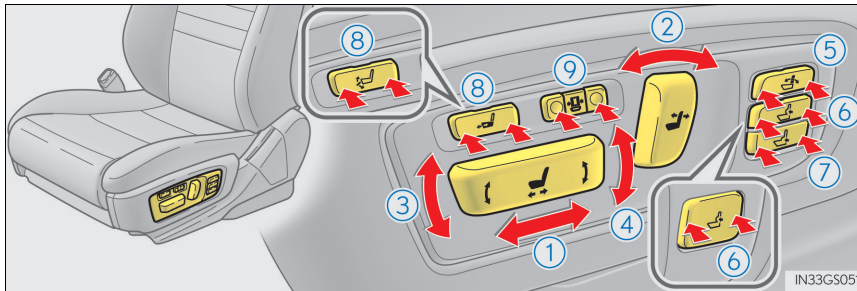

- | | |
|--|--|
| ① Seat position adjustment switch | ⑦ Pelvic support adjustment switch (if equipped) |
| ② Seatback angle adjustment switch | ⑧ Seat cushion length adjustment switch (if equipped) / ottoman angle adjustment switch (if equipped for front passenger's side) |
| ③ Seat cushion (front) angle adjustment switch | ⑨ Seatback side support adjustment switch (if equipped) |
| ④ Vertical height adjustment switch | |
| ⑤ Seatback upper angle adjustment switch (if equipped) | |
| ⑥ Lumbar support adjustment switch | |

3

Operation of each component

Seat operation switches on the side of the front passenger's seat (if equipped)

- ① Tilts the seatback forward
- ② Tilts the seatback backward
- ③ Moves the seat forward
- ④ Moves the seat backward

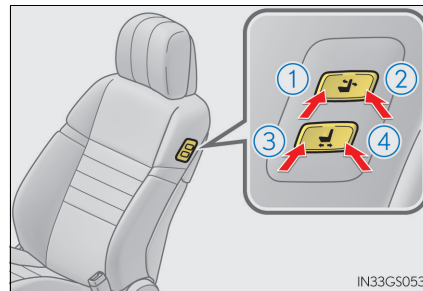

■ When adjusting the seat

Take care when adjusting the seat so that the head restraint does not touch the ceiling.

■ Power easy access system

The driver's seat and steering wheel move in accordance with power switch mode and the driver's seat belt condition. The passenger's seat moves when the passenger's door is opened. (→P. 178)

⚠ WARNING

■ When adjusting the seat position

- Take care when adjusting the seat position to ensure that other passengers are not injured by the moving seat.
- Do not put your hands under the seat or near the moving parts to avoid injury. Fingers or hands may become jammed in the seat mechanism.

■ Seat adjustment

To reduce the risk of sliding under the lap belt during a collision, do not recline the seat more than necessary.

If the seat is too reclined, the lap belt may slide past the hips and apply restraint forces directly to the abdomen, or your neck may contact the shoulder belt, increasing the risk of death or serious injury in the event of an accident.

Adjustments should not be made while driving as the seat may unexpectedly move and cause the driver to lose control of the vehicle.

 **WARNING****■ Operating the front passenger's seat from the driver's seat (if equipped)**

Do not operate the front passenger's seat when a passenger is seated in it. In addition, do not let anyone sit down in the front passenger's seat while the seat is being operated. The front passenger may catch their legs between the instrument panel and seat, resulting in injury.

■ When adjusting the seat positions or the ottoman (if equipped)

Make sure to leave enough space around the feet so they do not get stuck.

■ When using the ottoman (if equipped)

- Do not operate the ottoman when the vehicle is moving.
Failure to do so may cause death or serious injury in the event of sudden braking or a collision.
- Do not sit on the ottoman of the passenger seat.
Doing so may cause seat belts to be worn improperly, which may lead to serious injury or death in the event of sudden braking or a collision.
- Do not step on the ottoman.
Doing so could damage the ottoman, or could cause you to seriously injure yourself by falling over.
- Stow the ottoman when you get in or out of the vehicle or when the ottoman is not in use to avoid stumbling over it.
- Do not allow anyone to put their hands or feet under the passenger seat when stowing the ottoman.

 **NOTICE****■ Operating the front passenger's seat from the driver's seat (if equipped)**

Before operating the front passenger's seat, make sure that there is no luggage or any other objects on the seat or in the footwell that could prevent its operation. Such items may result in excess force being applied, causing damage to the seat and/or the luggage.

■ To prevent an ottoman malfunction (if equipped)

- Do not place any objects in the front passenger footwell that could prevent the operation of the ottoman.
- Do not place heavy luggage on the ottoman.
- Do not place anything under the ottoman when in use.
There is a possibility that something may get caught and cause damages when stowing the ottoman.

Driving position memory

This feature automatically adjusts the front seats, steering wheel and outside rear view mirrors to make entering and exiting the vehicle easier or to suit your preferences.

Power easy access system

The seat and steering wheel are automatically adjusted to allow the driver or front passenger to enter and exit the vehicle easily.

■ Driver's seat

When all of the following have been performed, the driver's seat and steering wheel are automatically adjusted to a position that allows driver to enter and exit the vehicle easily.

- The shift lever has been shifted to P.
- The power switch has been turned off.
- The driver's seat belt has been unfastened.

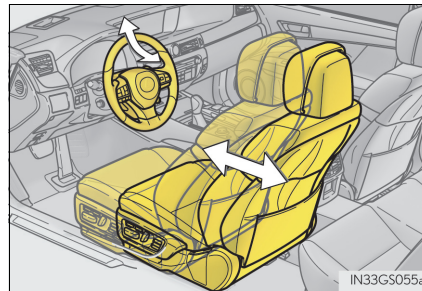

When any of the following has been performed, the driver's seat and steering wheel automatically return to their original positions.

- The power switch has been turned to ACCESSORY mode or ON mode.
- The driver's seat belt has been fastened.

■ Front passenger's seat (if equipped)

If the front passenger's door is opened while the vehicle is stopped, the adjusted lumbar support, ottoman (if equipped), etc. will return to its original position.

■ Operation of the power easy access system

When exiting the vehicle, the power easy access system may not operate if the seat is already close to the rearmost position, etc.

■ Customization

The seat movement amount settings of the power easy access system can be customized. (Customizable features: →P. 561)

Driving position memory

Your preferred driving position (the position of the driver's seat, steering wheel, outside rear view mirrors and HUD [head-up display] [if equipped]) can be recorded and recalled by pressing a button.

Three different driving positions can be recorded into memory.

■ Recording procedure

- 1 Check that the shift lever is in P.
- 2 Turn the power switch to ON mode.
- 3 Adjust the driver's seat, steering wheel, outside rear view mirrors and HUD (head-up display) (if equipped) to the desired positions.
- 4 While pressing the "SET" button, or within 3 seconds after the "SET" button is pressed, press button "1", "2" or "3" until the buzzer sounds.

If the selected button has already been preset, the previously recorded position will be overwritten.

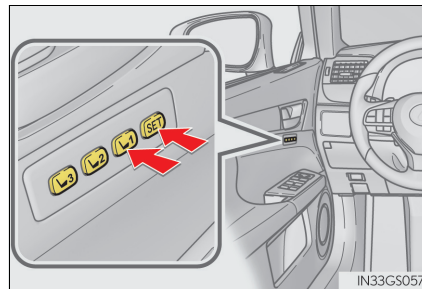

Vehicles with the driving position memory for the front passenger's seat: To record the position of the front passenger's seat, adjust the front passenger's seat to the desired position and perform step 4 using the buttons on the front passenger's side.

■ Recall procedure

- 1 Check that the shift lever is in P.
- 2 Turn the power switch to ON mode.
- 3 Press one of the buttons for the driving position you want to recall until the buzzer sounds.

Vehicles with front passenger's seat ottoman:
The recorded position will only be recalled if the ottoman is in a position higher than the recorded position. It will not move in an upward direction.

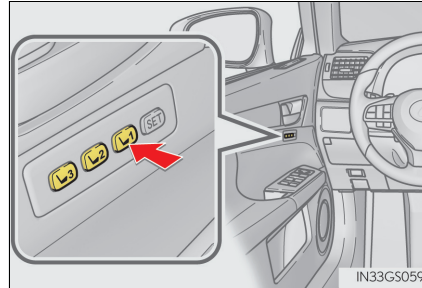

■ To stop the position recall operation part-way through

Perform any of the following:

- Press the "SET" button.
- Press button "1", "2" or "3".
- Operate any of the seat adjustment switches (only cancels seat position recall).
- Operate the tilt and telescopic steering control switch (only cancels steering wheel position recall).
- Operate the head-up display position adjustment switch (if equipped) (only cancels head-up display position recall).

■ Seat positions that can be memorized (→P. 175)

- ▶ Vehicles without seatback side support adjustment switch

The adjusted positions other than the position adjusted by lumbar support switch can be recorded.

- ▶ Vehicles with seatback side support adjustment switch

All adjusted positions can be recorded.

■ Automatic ottoman adjustment (if equipped)

While the recorded position is being recalled, if it appears that the front edge of the cushion will touch the area surrounding the instrument panel, the ottoman will be automatically stowed.

■ **Operating the driving position memory after turning the power switch off**

Driver's seat:

Recorded seat positions can be activated up to 180 seconds after the driver's door is opened and another 60 seconds after it is closed again.

Front passenger's seat:

Recorded seat positions can be activated up to 180 seconds after the front passenger's door is opened.

■ **In order to correctly use the driving position memory function**

If a seat position is already in the furthest possible position and the seat is operated in the same direction, the recorded position may be slightly different when it is recalled.

Memory recall function (driver's side only)

Each electronic key (including a card key) can be registered to recall your preferred driving position.

■ **Registering procedure**

Record your driving position to button "1", "2" or "3" before performing the following:

Carry only the key you want to register, and then close the driver's door.

If 2 or more keys are in the vehicle, the driving position cannot be recorded properly.

- 1 Check that the shift lever is in P.
- 2 Turn the power switch to ON mode.
- 3 Recall the driving position that you want to record.
- 4 While pressing the recalled button, press and hold the door lock switch (either lock or unlock) until the buzzer sounds.

If the button could not be registered, the buzzer sounds continuously for approximately 3 seconds.

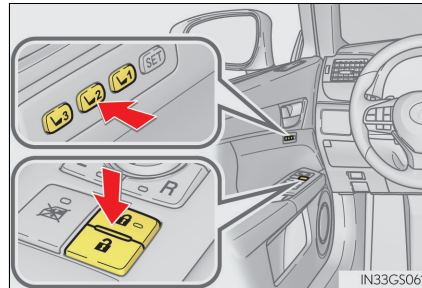

■ Recall procedure

- 1 Carry the electronic key that has been registered to the driving position, and then unlock and open the driver's door using the smart entry & start system or wireless remote control.

The driving position will move to the recorded position (not including the steering wheel and HUD [head-up display] [if equipped]). However, the seat will move to a position slightly behind the recorded position in order to make entering the vehicle easier.

If the driving position is in a position that has already been recorded, the seat and outside rear view mirrors will not move.

- 2 Turn the power switch to ACCESSORY mode or ON mode, or fasten a seat belt.

The seat, steering wheel and HUD (head-up display) (if equipped) will move to the recorded position.

■ Cancellation procedure

Carry only the key you want to cancel and then close the driver's door.

If 2 or more keys are in the vehicle, the driving position cannot be canceled properly.

- 1 Turn the power switch to ON mode.
- 2 While pressing the "SET" button, press and hold the door lock switch (either lock or unlock) until the buzzer sounds twice.

If the button could not be canceled, the buzzer sounds continuously for approximately 3 seconds.

■ Recalling the driving position using the memory recall function

- Different driving positions can be registered for each electronic key. Therefore, the driving position that is recalled may be different depending on the key being carried.
- If a door other than the driver's door is unlocked with the smart entry & start system, the driving position cannot be recalled. In this case, press the driving position button which has been set.

■ Customization

The unlock door settings of the memory recall function can be customized.
(Customizable features: →P. 561)

WARNING

■ Seat adjustment caution

Take care during seat adjustment so that the seat does not strike the rear passenger or squeeze your body against the steering wheel.

Head restraints

Head restraints are provided for all seats.

Front seats

▶ Vertical adjustment

① Up

Pull the head restraints up.

② Down

Push the head restraint down while pressing the lock release button.

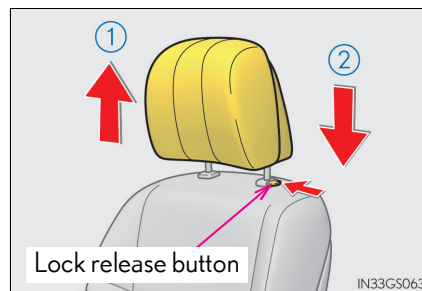

▶ Horizontal adjustment (if equipped)

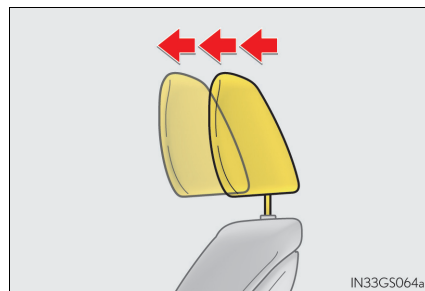

▶ Side support adjustment (if equipped)

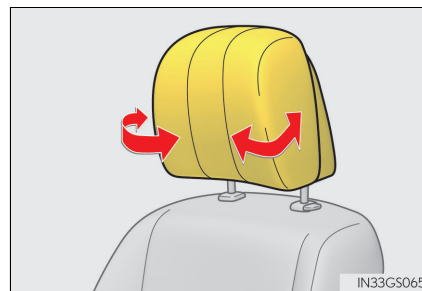

The position of the head restraint can be adjusted forward in 4 stages.

If the head restraint is pulled forward from the foremost position, it will return to the rearmost position.

3

Operation of each component

Rear seats

- ① Up
Pull the head restraints up.
- ② Down
Push the head restraint down while pressing the lock release button.

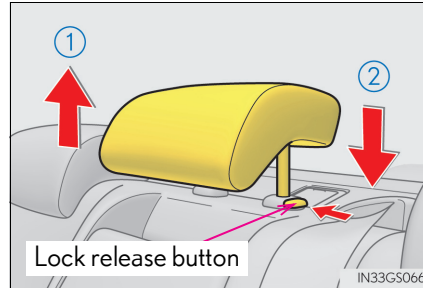

■ **Removing the head restraints**

Pull the head restraint up while pressing the lock release button.

Front seats: If the head restraint touches the ceiling, making the removal difficult, change the seat height or angle. (→P. 175)

Outboard rear seats (vehicles with rear sunshade): If the rear sunshade is raised, lower it before removing the head restraint. (→P. 380)

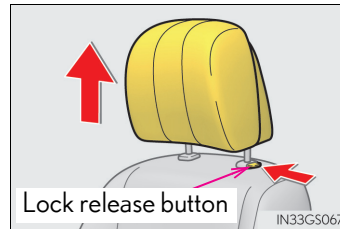

■ **Installing the head restraints**

▶ Front seats

Align the head restraint with the installation holes and push it down to the lock position. Press and hold the lock release button when lowering the head restraint.

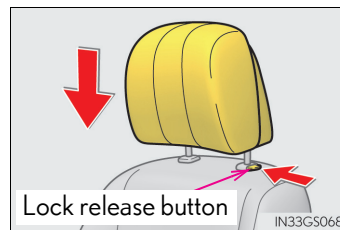

▶ Rear seats

Align the head restraint with the installation holes and push it down to the lowest lock position while pressing the lock release button.

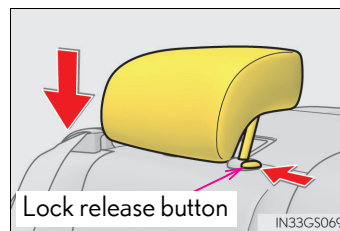

■ Adjusting the height of the head restraints

Make sure that the head restraints are adjusted so that the center of the head restraint is closest to the top of your ears.

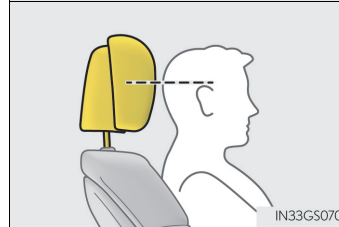
**■ Adjusting the rear seat head restraints**

Always raise the head restraint one level from the stowed position when using.

⚠ WARNING**■ Head restraint precautions**

Observe the following precautions regarding the head restraints. Failure to do so may result in death or serious injury.

- Use the head restraints designed for each respective seat.
- Adjust the head restraints to the correct position at all times.
- After adjusting the head restraints, push down on them and make sure they are locked in position.
- Do not drive with the head restraints removed.

Steering wheel

Adjustment procedure

Operating the switch moves the steering wheel in the following directions:

- ① Up
- ② Down
- ③ Toward the driver
- ④ Away from the driver

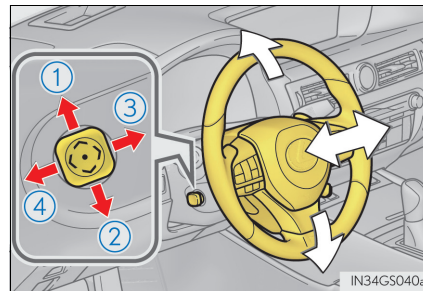

Horn

To sound the horn, press on or close to the  mark.

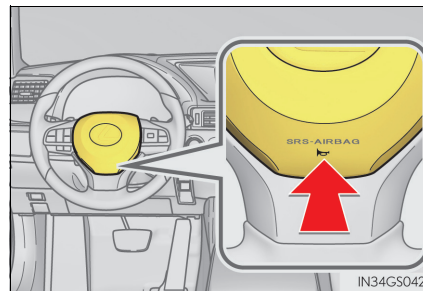

■ The steering wheel can be adjusted when

The power switch is in ACCESSORY or ON mode*.

*: If the driver's seat belt is fastened, the steering wheel can be adjusted regardless of power switch mode.

■ Automatic adjustment of the steering position

A desired steering position can be entered to memory and recalled automatically by the driving position memory system. (→P. 178)

■ Power easy access system

The steering wheel and driver's seat move in accordance with power switch mode and the driver's seat belt condition. (→P. 178)

⚠ WARNING

Do not adjust the steering wheel while driving.
Doing so may cause the driver to mishandle the vehicle and cause an accident, resulting in death or serious injury.

Inside rear view mirror

The rear view mirror's position can be adjusted to enable sufficient confirmation of the rear view.

Adjusting the height of rear view mirror

The height of the rear view mirror can be adjusted to suit your driving posture.

Adjust the height of the rear view mirror by moving it up and down.

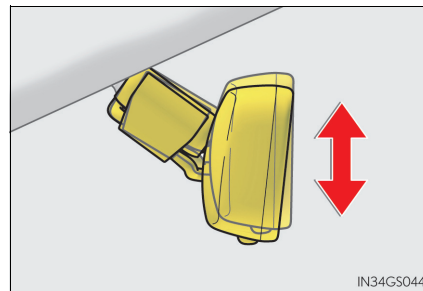

Anti-glare function

Responding to the level of brightness of the headlights of vehicles behind, the reflected light is automatically reduced.

Changing automatic anti-glare function mode

ON/OFF

When the automatic anti-glare function is in ON mode, the indicator illuminates. The function will set to ON mode each time the power switch is turned to ON mode.

Pressing the button turns the function to OFF mode. (The indicator also turns off.)

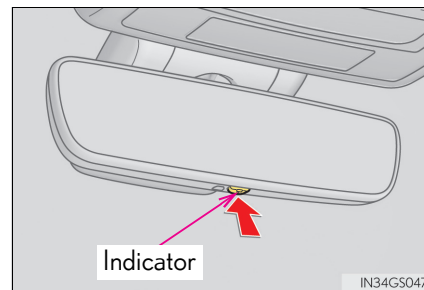

■ To prevent sensor error

To ensure that the sensors operate properly, do not touch or cover them.

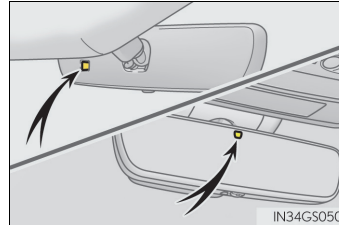
**⚠ WARNING**

Do not adjust the position of the mirror while driving.
Doing so may lead to mishandling of the vehicle and cause an accident, resulting in death or serious injury.

Outside rear view mirrors

Adjustment procedure

- 1** To select a mirror to adjust, press the switch.

- ① Left
- ② Right

Pressing the same switch again will put the switch in neutral.

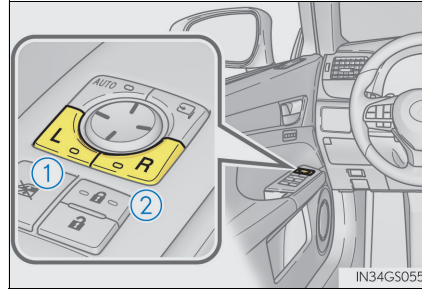

- 2** To adjust the mirror, press the switch.

- ① Up
- ② Right
- ③ Down
- ④ Left

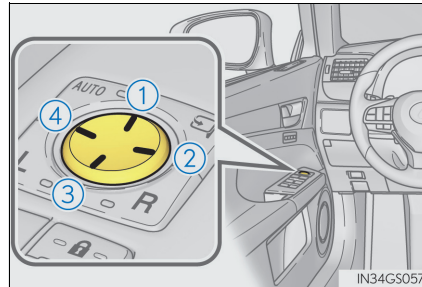

Folding and extending the mirrors

■ Using the switch

Press the switch to fold the mirrors.

Press it again to extend them to the original position.

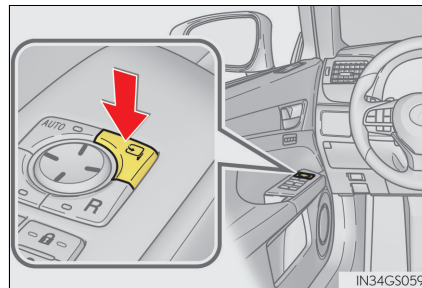

■ Setting automatic mode

Automatic mode allows the folding or extending of the mirrors to be linked to locking/unlocking of the doors.

Press the "AUTO" switch to set automatic mode.

The indicator will come on.

Pressing the switch once more will return to manual mode.

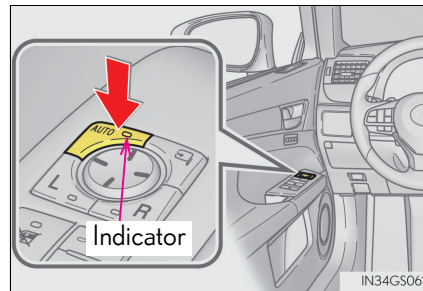

Linked mirror function when reversing

When either "L" or "R" of the mirror select switch is selected, the outside rear view mirrors will automatically angle downwards when the vehicle is reversing in order to give a better view of the ground. To disable this function, select neither "L" nor "R".

■ Adjusting the mirror angle when the vehicle is reversing

With the shift lever in R, adjust the mirror angle at a desired position.

The adjusted angle will be memorized and the mirror will automatically tilt to the memorized angle whenever the shift lever is shifted to R from next time.

The memorized downward tilt position of the mirror is linked to the normal position (angle adjusted with the shift lever in other than R). Therefore, if the normal position is changed after adjustment, the tilt position will also change.

When the normal position is changed, readjust the angle in reversing.

■ Mirror angle can be adjusted when

The power switch is in ACCESSORY or ON mode.

■ When the mirrors are fogged up

The outside rear view mirrors can be cleared using the mirror defoggers. Turn on the rear window defogger to turn on the outside rear view mirror defoggers. (→P. 352)

■ Automatic adjustment of the mirror angle

A desired mirror face angle can be entered to memory and recalled automatically by the driving position memory. (→P. 178)

■ Auto anti-glare function

When the anti-glare inside rear view mirror is set to automatic mode, the outside rear view mirrors will activate in conjunction with the anti-glare inside rear view mirror to reduce reflected light. (→P. 188)

■ Using automatic mode in cold weather

When automatic mode is used in cold weather, the door mirror could freeze up and automatic stowing and return may not be possible. In this event, remove any ice and snow from the door mirror, then either operate the mirror using manual mode or move the mirror by hand.

⚠ WARNING**■ Important points while driving**

Observe the following precautions while driving.

Failure to do so may result in loss of control of the vehicle and cause an accident, resulting in death or serious injury.

- Do not adjust the mirrors while driving.
- Do not drive with the mirrors folded.
- Both the driver and passenger side mirrors must be extended and properly adjusted before driving.

■ When a mirror is moving

To avoid personal injury and mirror malfunction, be careful not to get your hand caught by the moving mirror.

■ When the mirror defoggers are operating

Do not touch the rear view mirror surfaces, as they can become very hot and burn you.

Power windows

Opening and closing procedures

The power windows can be opened and closed using the switches.

Operating the switch moves the windows as follows:

- ① Closing
- ② One-touch closing*
- ③ Opening
- ④ One-touch opening*

*: To stop the window partway, operate the switch in the opposite direction.

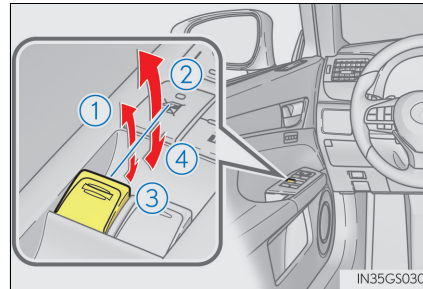

Window lock switch

Press the switch to lock the passenger window switches.

The indicator will come on.

Use this switch to prevent children from accidentally opening or closing a passenger window.

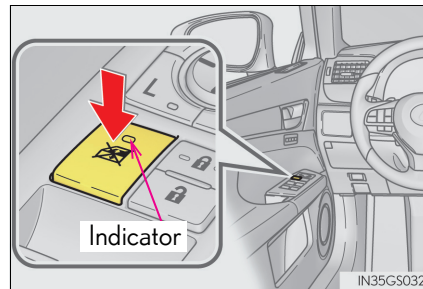

■ The power windows can be operated when

The power switch is in ON mode.

■ Operating the power windows after turning the hybrid system off

The power windows can be operated for approximately 45 seconds even after the power switch is turned to ACCESSORY mode or turned off. They cannot, however, be operated once either front door is opened.

■ Jam protection function

If an object becomes jammed between the window and the window frame while the window is closing, window movement is stopped and the window is opened slightly.

■ Catch protection function

If an object becomes caught between the door and window while the window is opening, window movement is stopped.

■ When the window cannot be opened or closed

When the jam protection function or catch protection function operates unusually and the door window cannot be opened or closed, perform the following operations with the power window switch of that door.

- Stop the vehicle. With the power switch in ON mode, within 4 seconds of the jam protection function or catch protection function activating, continuously operate the power window switch in the one-touch closing direction or one-touch opening direction so that the door window can be opened and closed.
- If the door window cannot be opened and closed even when performing the above operations, perform the following procedure for function initialization.
 - 1 Turn the power switch to ON mode.
 - 2 Pull and hold the power window switch in the one-touch closing direction and completely close the door window.
 - 3 Release the power window switch for a moment, resume pulling the switch in the one-touch closing direction, and hold it there for approximately 6 seconds or more.
 - 4 Press and hold the power window switch in the one-touch opening direction. After the door window is completely opened, continue holding the switch for an additional 1 second or more.
 - 5 Release the power window switch for a moment, resume pushing the switch in the one-touch opening direction, and hold it there for approximately 4 seconds or more.
 - 6 Pull and hold the power window switch in the one-touch closing direction again. After the door window is completely closed, continue holding the switch for a further 1 second or more.

If you release the switch while the window is moving, start again from the beginning.

If the window reverses and cannot be fully closed or opened, have the vehicle inspected by any authorized Lexus retailer or Lexus authorized repairer, or any reliable repairer.

■ Door lock linked window operation

- The power windows can be opened and closed using the mechanical key.* (→P. 527)
- The power windows can be opened and closed using the wireless remote control.* (→P. 139)

*: These settings must be customized at any authorized Lexus retailer or Lexus authorized repairer, or any reliable repairer.

■ When the 12-volt battery is disconnected

The window lock switch is disabled. If necessary, press the window lock switch after reconnecting the 12-volt battery.

■ Power windows open warning buzzer

The buzzer sounds and a message is shown on the multi-information display in the instrument cluster when the power switch is turned off and the driver's door is opened with the power windows open.

■ Customization

Settings (e.g. linked door lock operation) can be changed.
(Customizable features: →P. 561)

 **WARNING**

Observe the following precautions.
Failure to do so may result in death or serious injury.

■ Closing the windows

- The driver is responsible for all the power window operations, including the operation for the passengers. In order to prevent accidental operation, especially by a child, do not let a child operate the power windows. It is possible for children and other passengers to have body parts caught in the power window. Also, when riding with a child, it is recommended to use the window lock switch. (→P. 193)
- Check to make sure that all passengers do not have any part of their body in a position where it could be caught when a window is being operated.
- When using the wireless remote control or mechanical key and operating the power windows, operate the power window after checking to make sure that there is no possibility of any passenger having any of their body parts caught in the window. Also do not let a child operate window by the wireless remote control or mechanical key. It is possible for children and other passengers to get caught in the power window.
- When exiting the vehicle, turn the power switch off, carry the key and exit the vehicle along with the child. There may be accidental operation, due to mischief, etc., that may possibly lead to an accident.

■ Jam protection function

- Never use any part of your body to intentionally activate the jam protection function.
- The jam protection function may not work if something gets jammed just before the window is fully closed. Be careful not to get any part of your body jammed in the window.

■ Catch protection function

- Never use any part of your body or clothing to intentionally activate the catch protection function.
- The catch protection function may not work if something gets caught just before the window is fully opened. Be careful not to get any part of your body or clothing caught in the window.

Moon roof*

Use the overhead switches to open and close the moon roof and tilt it up and down.

Opening and closing

- ① Opens the moon roof*
The moon roof stops slightly before the fully open position to reduce wind noise. Press the switch again to fully open the moon roof.
 - ② Closes the moon roof*
- *: Lightly press either way of the moon roof switch to stop the moon roof part-way.

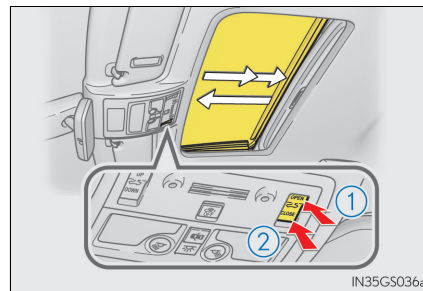

Tilting up and down

- ① Tilts the moon roof up*
 - ② Tilts the moon roof down*
- *: Lightly press either way of the moon roof switch to stop the moon roof part-way.

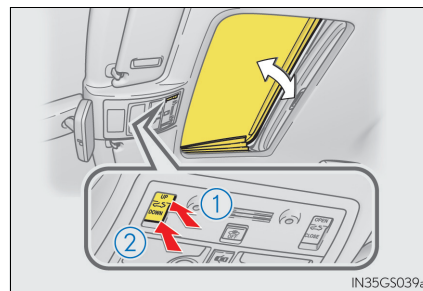

■ The moon roof can be operated when

The power switch is in ON mode.

■ Operating the moon roof after turning the hybrid system off

The moon roof can be operated for approximately 45 seconds after the power switch is turned to ACCESSORY mode or turned off. It cannot, however, be operated once either front door is opened.

*: If equipped

■ Jam protection function

If an object is detected between the moon roof and the frame while the moon roof is closing or tilting down, travel is stopped and the moon roof opens slightly.

■ Sunshade

The sunshade can be opened and closed manually. However, the sunshade will open automatically when the moon roof is opened.

■ Door lock linked moon roof operation

- The moon roof can be opened and closed using the mechanical key. * (→P. 527)
- The moon roof can be opened and closed using the wireless remote control. * (→P. 139)

*: These settings must be customized at any authorized Lexus retailer or Lexus authorized repairer, or any reliable repairer.

■ When the moon roof does not close normally

Perform the following procedure:

- If the moon roof closes but then re-opens slightly

- 1 Stop the vehicle.
- 2 Press and hold the "CLOSE" switch. *1
The moon roof will close, reopen and pause for approximately 10 seconds. *2 Then it will close again, tilt up and pause for approximately 1 second. Finally, it will tilt down, open and close.
- 3 Check to make sure that the moon roof is completely closed and then release the switch.

- If the moon roof tilts down but then tilts back up

- 1 Stop the vehicle.
- 2 Press and hold the "UP" switch *1 until the moon roof moves into the tilt up position and stops.
- 3 Release the "UP" switch once and then press and hold the "UP" switch again. *1
The moon roof will pause for approximately 10 seconds in the tilt up position. *2 Then it will adjust slightly and pause for approximately 1 second. Finally, it will tilt down, open and close.
- 4 Check to make sure that the moon roof is completely closed and then release the switch.

*1: If the switch is released at the incorrect time, the procedure will have to be performed again from the beginning.

*2: If the switch is released after the above mentioned 10 second pause, automatic operation will be disabled. In that case, press and hold the "CLOSE" or "UP" switch, and the moon roof will tilt up and pause for approximately 1 second. Then it will tilt down, open and close. Check to make sure that the moon roof is completely closed and then release the switch.

If the moon roof does not fully close even after performing the above procedure correctly, have the vehicle inspected by any authorized Lexus retailer or Lexus authorized repairer, or any reliable repairer.

■ Moon roof open warning buzzer

The buzzer sounds and a message is shown on the multi-information display in the instrument cluster when the power switch is turned off and the driver's door is opened with the moon roof open.

■ Customization

Settings (e.g. linked door lock operation) can be changed.
(Customizable features: →P. 561)

**WARNING**

Observe the following precautions.
Failure to do so may cause death or serious injury.

■ Opening the moon roof

- Do not allow any passengers to put their hands or heads outside the vehicle while it is moving.
- Do not sit on top of the moon roof.

■ Closing the moon roof

- The driver is responsible for moon roof opening and closing operations.
In order to prevent accidental operation, especially by a child, do not let a child operate the moon roof. It is possible for children and other passengers to have body parts caught in the moon roof.
- Check to make sure that all passengers do not have any part of their body in a position where it could be caught when the moon roof is being operated.
- When using the wireless remote control or mechanical key and operating the moon roof, operate the moon roof after checking to make sure that there is no possibility of any passenger having any of their body parts caught in the moon roof. Also, do not let a child operate moon roof by the wireless remote control or mechanical key. It is possible for children and other passengers to get caught in the moon roof.
- When exiting the vehicle, turn the power switch off, carry the key and exit the vehicle along with the child. There may be accidental operation, due to mischief, etc., that may possibly lead to an accident.

■ Jam protection function

- Never use any part of your body to intentionally activate the jam protection function.
- The jam protection function may not work if something gets caught just before the moon roof fully closes.

Driving

4

- | | |
|---|---|
| <p>4-1. Before driving</p> <p>Driving the vehicle..... 200</p> <p>Cargo and luggage.....208</p> <p>Trailer towing (vehicles without towing package)209</p> <p>Trailer towing (vehicles with towing package)..... 210</p> <p>4-2. Driving procedures</p> <p>Power (ignition) switch.....217</p> <p>EV drive mode 222</p> <p>Hybrid transmission 224</p> <p>Turn signal lever 231</p> <p>Parking brake232</p> <p>Brake Hold.....235</p> <p>4-3. Operating the lights and wipers</p> <p>Headlight switch.....237</p> <p>AHS (Adaptive High-beam System)..... 241</p> <p>Automatic High Beam246</p> <p>Fog light switch 250</p> <p>Windshield wipers and washer..... 251</p> | <p>4-4. Refueling</p> <p>Opening the fuel tank cap 257</p> <p>4-5. Using the driving support systems</p> <p>Lexus Safety System+261</p> <p>PCS (Pre-Crash Safety system) 270</p> <p>LKA (Lane-Keeping Assist)282</p> <p>RSA (Road Sign Assist)291</p> <p>Dynamic radar cruise control with full-speed range 296</p> <p>Cruise control 308</p> <p>Driving mode select switch 311</p> <p>BSM (Blind Spot Monitor)..... 314</p> <ul style="list-style-type: none"> • The Blind Spot Monitor function 319 • The Rear Crossing Traffic Alert function.....321 <p>Driving assist systems 324</p> <p>4-6. Driving tips</p> <p>Hybrid vehicle driving tips 331</p> <p>Winter driving tips334</p> |
|---|---|

Driving the vehicle

The following procedures should be observed to ensure safe driving:

Starting the hybrid system

→P. 217

Driving

- 1 With the brake pedal depressed, shift the shift lever to D. (→P. 224)
- 2 If the parking brake is in manual mode, release the parking brake. (→P. 232)
- 3 Gradually release the brake pedal and gently depress the accelerator pedal to accelerate the vehicle.

Stopping

- 1 With the shift lever in D, depress the brake pedal.
- 2 If necessary, set the parking brake.
If the vehicle is to be stopped for an extended period of time, shift the shift lever to P. (→P. 224)

Parking the vehicle

- 1 With the shift lever in D, depress the brake pedal.
- 2 Set the parking brake (→P. 232), and shift the shift lever to P. (→P. 224)
- 3 Press the power switch to stop the hybrid system.
- 4 Lock the door, making sure that you have the electronic key on your person.
If parking on a hill, block the wheels as needed.

Starting off on a steep uphill

- 1 Make sure that the parking brake is set and shift the shift lever to D.
- 2 Gently depress the accelerator pedal.
- 3 Release the parking brake.

■ When starting off on an uphill

The hill-start assist control is available. (→P. 325)

■ For fuel-efficient driving

Keep in mind that hybrid vehicles are similar to conventional vehicles, and it is necessary to refrain from activities such as sudden acceleration, etc. Refer to "Hybrid vehicle driving tips". (→P. 331)

■ Driving in the rain

- Drive carefully when it is raining, because visibility will be reduced, the windows may become fogged-up, and the road will be slippery.
- Drive carefully when it starts to rain, because the road surface will be especially slippery.
- Refrain from high speeds when driving on an expressway in the rain, because there may be a layer of water between the tires and the road surface, preventing the steering and brakes from operating properly.

■ Restraining hybrid system output (Brake Override System)

- When the accelerator and brake pedals are depressed at the same time, the hybrid system output may be restrained.
- A warning message is displayed on the multi-information display while the system is operating. (→P. 485)

■ Restraining sudden start (Drive-Start Control)

- When the following unusual operation is performed, the hybrid system output may be restrained.
 - When the shift lever is shifted from R to D, D to R, N to R, P to D, or P to R (D includes S) with the accelerator pedal depressed, a warning message appears on the multi-information display. (→P. 473)
 - When the accelerator pedal is depressed too much while the vehicle is in reverse.
- While Drive-Start Control is being activated, your vehicle may have trouble escaping from the mud or fresh snow. In such case, deactivate TRC (→P. 326) to cancel Drive-Start Control so that the vehicle may become able to escape from the mud or fresh snow.

■ Breaking in your new Lexus

To extend the life of the vehicle, observing the following precautions is recommended:

- For the first 300 km (186 miles):
Avoid sudden stops.
- For the first 800 km (500 miles):
Do not tow a trailer.
- For the first 1000 km (621 miles):
 - Do not drive at extremely high speeds.
 - Avoid sudden acceleration.
 - Do not drive continuously in low gears.
 - Do not drive at a constant speed for extended periods.

■ Drum-in-disc type parking brake system

Your vehicle has a drum-in-disc type parking brake system. This type of brake system needs bedding-down of the brake shoes periodically or whenever the parking brake shoes and/or drum are replaced. Have any authorized Lexus retailer or Lexus authorized repairer, or any reliable repairer perform the bedding down operation.

■ Operating your vehicle in a foreign country

Comply with the relevant vehicle registration laws and confirm the availability of the correct fuel. (→P. 549)

⚠ WARNING

Observe the following precautions.
Failure to do so may result in death or serious injury.

■ When starting the vehicle

Always keep your foot on the brake pedal while stopped with the "READY" indicator is illuminated. This prevents the vehicle from creeping.

■ When driving the vehicle

- Do not drive if you are unfamiliar with the location of the brake and accelerator pedals to avoid depressing the wrong pedal.
 - Accidentally depressing the accelerator pedal instead of the brake pedal will result in sudden acceleration that may lead to an accident.
 - When backing up, you may twist your body around, leading to a difficulty in operating the pedals. Make sure to operate the pedals properly.
 - Make sure to keep a correct driving posture even when moving the vehicle only slightly. This allows you to depress the brake and accelerator pedals properly.
 - Depress the brake pedal using your right foot. Depressing the brake pedal using your left foot may delay response in an emergency, resulting in an accident.
- The driver should pay extra attention to pedestrians when the vehicle is powered only by the electric motor (traction motor). As there is no engine noise, the pedestrians may misjudge the vehicle's movement.
- Do not drive the vehicle over or stop the vehicle near flammable materials. The exhaust system and exhaust gases can be extremely hot. These hot parts may cause a fire if there is any flammable material nearby.
- During normal driving, do not turn off the hybrid system. Turning the hybrid system off while driving will not cause loss of steering or braking control, however, power assist to the steering will be lost. This will make it more difficult to steer smoothly, so you should pull over and stop the vehicle as soon as it is safe to do so.
In the event of an emergency, such as if it becomes impossible to stop the vehicle in the normal way: →P. 453
- Use engine braking (downshift) to maintain a safe speed when driving down a steep hill.
Using the brakes continuously may cause the brakes to overheat and lose effectiveness. (→P. 224)
- Do not adjust the positions of the steering wheel, the seat, or the inside or outside rear view mirrors while driving.
Doing so may result in a loss of vehicle control.
- Always check that all passengers' arms, heads or other parts of their body are not outside the vehicle.

⚠ WARNING

Observe the following precautions.
Failure to do so may result in death or serious injury.

■ **When driving on slippery road surfaces**

- Sudden braking, acceleration and steering may cause tire slippage and reduce your ability to control the vehicle.
- Sudden acceleration, engine braking due to shifting, or changes in engine speed could cause the vehicle to skid, resulting in an accident.
- After driving through a puddle, lightly depress the brake pedal to make sure that the brakes are functioning properly. Wet brake pads may prevent the brakes from functioning properly. If the brakes on only one side are wet and not functioning properly, steering control may be affected.

■ **When shifting the shift lever**

- Do not let the vehicle roll backward while the shift lever is in a driving position, or roll forward while the shift lever is in R.
Doing so may result in an accident or damage to the vehicle.
- Do not shift the shift lever to P while the vehicle is moving.
Doing so can damage the transmission and may result in a loss of vehicle control.
- Do not shift the shift lever to R while the vehicle is moving forward.
Doing so can damage the transmission and may result in a loss of vehicle control.
- Do not shift the shift lever to a driving position while the vehicle is moving backward.
Doing so can damage the transmission and may result in a loss of vehicle control.
- Shifting the shift lever to N while the vehicle is moving will disengage the hybrid system. Engine braking is not available with the hybrid system disengaged.
- Be careful not to shift the shift lever with the accelerator pedal depressed. Shifting the shift lever to any position other than P or N may lead to unexpected rapid acceleration of the vehicle that may cause an accident and result in death or serious injury.

■ **If you hear a squealing or scraping noise (brake pad wear indicators)**

Have the brake pads checked and replaced by any authorized Lexus retailer or Lexus authorized repairer, or any reliable repairer as soon as possible.
Rotor damage may result if the pads are not replaced when needed.

Front and rear* brakes: Moderate levels of brake pad and disc wear allow enhanced braking power. As a result, the discs may wear more quickly than conventional brake discs. Therefore, when replacing the brake pads, Lexus recommends that you also have the thickness of the discs measured.

It is dangerous to drive the vehicle when the wear limits of the brake pads and/or those of the brake discs are exceeded.

*: Except for Reunion, Canary Islands, Russia, Ukraine, Israel, Turkey, Kazakhstan, Georgia

⚠ WARNING

Observe the following precautions.
Failure to do so may result in death or serious injury.

■ When the vehicle is stopped

- Do not depress the accelerator pedal unnecessarily.
If the shift lever is any position other than P or N, the vehicle may accelerate suddenly and unexpectedly, causing an accident.
- In order to prevent accidents due to the vehicle rolling away, always keep depressing the brake pedal while stopped with the "READY" indicator is illuminated, and apply the parking brake as necessary.
- If the vehicle is stopped on an incline, in order to prevent accidents caused by the vehicle rolling forward or backward, always depress the brake pedal and securely apply the parking brake as needed.
- Avoid revving or racing the engine.
Running the engine at high speed while the vehicle is stopped may cause the exhaust system to overheat, which could result in a fire if combustible material is nearby.

■ When the vehicle is parked

- Do not leave glasses, cigarette lighters, spray cans, or soft drink cans in the vehicle when it is in the sun.
Doing so may result in the following:
 - Gas may leak from a cigarette lighter or spray can, and may lead to a fire.
 - The temperature inside the vehicle may cause the plastic lenses and plastic material of glasses to deform or crack.
 - Soft drink cans may fracture, causing the contents to spray over the interior of the vehicle, and may also cause a short circuit in the vehicle's electrical components.
- Do not leave cigarette lighters in the vehicle. If a cigarette lighter is in a place such as the glove box or on the floor, it may be lit accidentally when luggage is loaded or the seat is adjusted, causing a fire.
- Do not attach adhesive discs to the windshield or windows. Do not place containers such as air fresheners on the instrument panel or dashboard. Adhesive discs or containers may act as lenses, causing a fire in the vehicle.
- Do not leave a door or window open if the curved glass is coated with a metallized film such as a silver-colored one. Reflected sunlight may cause the glass to act as a lens, causing a fire.
- Always apply the parking brake, shift the shift lever to P, stop the hybrid system and lock the vehicle.
Do not leave the vehicle unattended while the "READY" indicator is illuminated.
If the vehicle is parked with the shift lever in P but the parking brake is not set, the vehicle may start to move, possibly leading to an accident.
- Do not touch the exhaust pipes while the "READY" indicator is illuminated or immediately after turning the hybrid system off.
Doing so may cause burns.

 **WARNING**

Observe the following precautions.
Failure to do so may result in death or serious injury.

■ When taking a nap in the vehicle

Always turn the hybrid system off. Otherwise, if you accidentally move the shift lever or depress the accelerator pedal, this could cause an accident or fire due to hybrid system overheating. Additionally, if the vehicle is parked in a poorly ventilated area, exhaust gases may collect and enter the vehicle, leading to death or a serious health hazard.

■ When braking

- When the brakes are wet, drive more cautiously.
Braking distance increases when the brakes are wet, and this may cause one side of the vehicle to brake differently than the other side. Also, the parking brake may not securely hold the vehicle.
- If the electronically controlled brake system does not operate, do not follow other vehicles closely and avoid hills or sharp turns that require braking.
In this case, braking is still possible, but the brake pedal should be depressed more firmly than usual. Also, the braking distance will increase. Have your brakes fixed immediately.
- The brake system consists of 2 or more individual hydraulic systems; if one of the systems fails, the other(s) will still operate. In this case, the brake pedal should be depressed more firmly than usual and the braking distance will increase. Have your brakes fixed immediately.

■ If the vehicle becomes stuck

Do not spin the wheels excessively when any of the tires is up in the air, or the vehicle is stuck in sand, mud, etc. This may damage the driveline components or propel the vehicle forward or backward, causing an accident.

 NOTICE

■ When driving the vehicle

- Do not depress the accelerator and brake pedals at the same time during driving, as this may restrain the hybrid system output.
- Do not use the accelerator pedal or depress the accelerator and brake pedals at the same time to hold the vehicle on a hill.

■ When parking the vehicle

Always set the parking brake, and shift the shift lever to P. Failure to do so may cause the vehicle to move or the vehicle may accelerate suddenly if the accelerator pedal is accidentally depressed.

■ Avoiding damage to vehicle parts

- Do not turn the steering wheel fully in either direction and hold it there for an extended period of time.
Doing so may damage the power steering motor.
- When driving over bumps in the road, drive as slowly as possible to avoid damaging the wheels, underside of the vehicle, etc.

■ If you get a flat tire while driving

A flat or damaged tire may cause the following situations. Hold the steering wheel firmly and gradually depress the brake pedal to slow down the vehicle.

- It may be difficult to control your vehicle.
- The vehicle will make abnormal sounds or vibrations.
- The vehicle will lean abnormally.

Information on what to do in case of a flat tire (→P. 498, 509)

■ When encountering flooded roads

Do not drive on a road that has flooded after heavy rain etc. Doing so may cause the following serious damage to the vehicle:

- Engine stalling
- Short in electrical components
- Engine damage caused by water immersion

In the event that you drive on a flooded road and the vehicle is flooded, be sure to have any authorized Lexus retailer or Lexus authorized repairer, or any reliable repairer check the following:

- Brake function
- Changes in quantity and quality of oil and fluid used for the engine, hybrid transmission, differential, etc.
- Lubricant condition for the propeller shaft, bearings and suspension joints (where possible), and the function of all joints, bearings, etc.

Cargo and luggage

Take notice of the following information about storage precautions, cargo capacity and load:

WARNING

■ Things that must not be carried in the trunk

The following things may cause a fire if loaded in the trunk:

- Receptacles containing gasoline
- Aerosol cans

■ Storage precautions

Observe the following precautions.

Failure to do so may prevent the pedals from being depressed properly, may block the driver's vision, or may result in items hitting the driver or passengers, possibly causing an accident.

- Stow cargo and luggage in the trunk whenever possible.
- Do not place cargo or luggage in or on the following locations.
 - At the feet of the driver
 - On the front passenger or rear seats (when stacking items)
 - On the package tray
 - On the instrument panel
 - On the dashboard
 - In front of the Remote Touch screen
- Secure all items in the occupant compartment.

■ Load and distribution

- Do not overload your vehicle.
- Do not apply loads unevenly.
Improper loading may cause deterioration of steering or braking control which may cause death or serious injury.

Trailer towing (vehicles without towing package)

Lexus does not recommend towing a trailer with your vehicle. Lexus also does not recommend the installation of a tow hitch or the use of a tow hitch carrier for a wheelchair, scooter, bicycle, etc. Your vehicle is not designed for trailer towing or for the use of tow hitch mounted carriers.

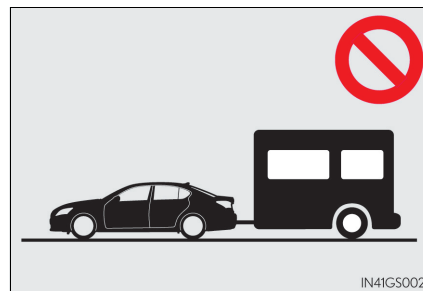

Trailer towing (vehicles with towing package)

Your vehicle is designed primarily as a passenger carrying vehicle. Towing a trailer will have an adverse effect on handling, performance, braking, durability, and fuel consumption. Your safety and satisfaction depend on the proper use of correct equipment and cautious driving habits. For your safety and the safety of others, do not overload the vehicle or trailer.

To tow a trailer safely, use extreme care and drive the vehicle in accordance with the trailer's characteristics and operating conditions.

Lexus warranties do not apply to damage or malfunction caused by towing a trailer for commercial purposes.

Ask your local authorized Lexus retailer or Lexus authorized repairer, or any reliable repairer for further details before towing, as there are additional legal requirements in some countries.

◆ Weight limits

Check the allowable towing capacity, GVM (Gross Vehicle Mass), MPAC (Maximum Permissible Axle Capacity), and permissible drawbar load before towing. (→P. 546)

◆ Towing hitch/bracket

Lexus recommends the use of the Lexus hitch/bracket for your vehicle. Other products of a suitable nature and comparable quality may also be used.

Important points regarding trailer loads

■ **Total trailer weight and permissible drawbar load**

① Total trailer weight

Weight of the trailer itself plus the trailer load should be within the maximum towing capacity. Exceeding this weight is dangerous. (→P. 546)
When towing a trailer, use a friction coupler or friction stabilizer (sway control device).

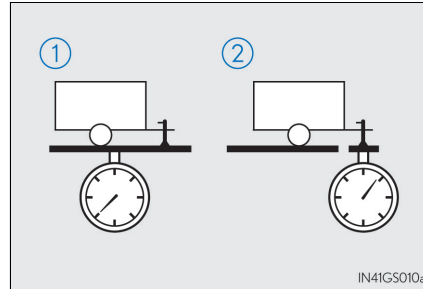

② Permissible drawbar load

Allocate the trailer load so that the drawbar load is greater than 25 kg (55.1 lb.) or 4% of the towing capacity. Do not let the drawbar load exceed the indicated weight. (→P. 546)

■ **Information tag (manufacturer's label)**

① Gross vehicle mass

The combined weight of the driver, passengers, towing hitch, luggage, total curb mass and drawbar load should not exceed the gross vehicle mass by more than 100 kg (220.5 lb.). Exceeding this weight is dangerous.

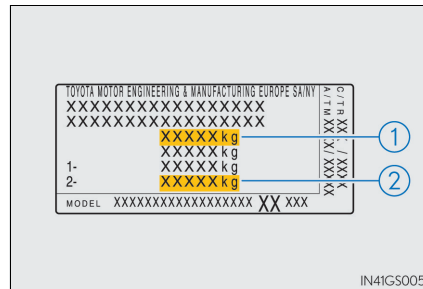

② Maximum permissible rear axle capacity

The weight borne by the rear axle should not exceed the maximum permissible axle capacity by 15% or more. Exceeding this weight is dangerous.

The values for towing capacity were derived from testing conducted at sea level. Take note that engine output and towing capacity will be reduced at high altitudes.

⚠ WARNING

■ **When the gross vehicle mass limit or maximum permissible axle capacity is exceeded**
Do not exceed the established speed limit for towing a trailer in built-up areas or 100 km/h (62 mph), whichever is lower.
Failing to observe this precaution may lead to an accident causing death or serious injury.

Installation positions for the towing hitch/bracket and hitch ball

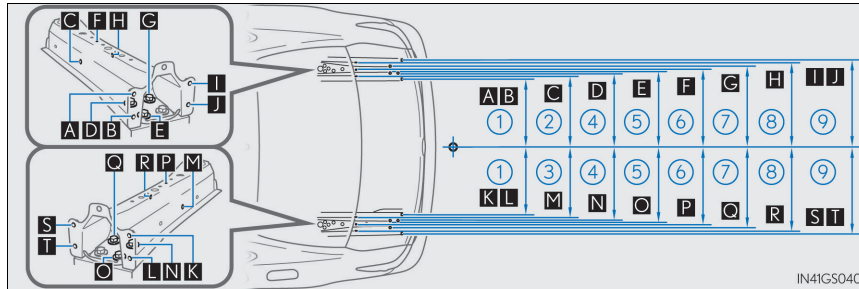

- ① 436 mm (17.2 in.)
- ② 455 mm (17.9 in.)
- ③ 454 mm (17.9 in.)
- ④ 475 mm (18.7 in.)
- ⑤ 476 mm (18.7 in.)
- ⑥ 500 mm (19.7 in.)
- ⑦ 520 mm (20.5 in.)
- ⑧ 543 mm (21.4 in.)
- ⑨ 560 mm (22.0 in.)

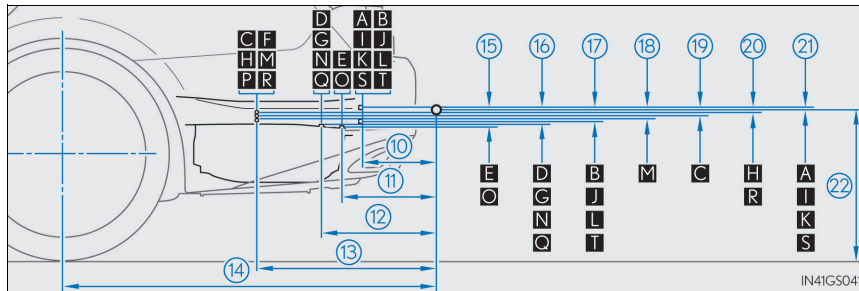

- ⑩ 289 mm (11.4 in.)
 - ⑪ 322 mm (12.7 in.)
 - ⑫ 374 mm (14.7 in.)
 - ⑬ 592 mm (23.3 in.)
 - ⑭ 1201 mm (47.3 in.)
 - ⑮ 61 mm (2.4 in.)
 - ⑯ 56 mm (2.2 in.)
 - ⑰ 37 mm (1.5 in.)
 - ⑱ 27 mm (1.1 in.)
 - ⑲ 18 mm (0.7 in.)
 - ⑳ 12 mm (0.5 in.)
 - ㉑ 8 mm (0.3 in.)
 - ㉒ 401 mm (15.8 in.)*¹
 - 408 mm (16.1 in.)*²
 - 410 mm (16.1 in.)*³
- *¹: 225/50R17 tires
 *²: 235/45R18 tires
 *³: 235/40R19 tires or 265/35R19 tires

■ Tire information

- Increase the tire inflation pressure to 20.0 kPa (0.2 kgf/cm² or bar, 3 psi) greater than the recommended value when towing. (→P. 555)
- Increase the air pressure of the trailer tires in accordance with the total trailer weight and according to the values recommended by the manufacturer of your trailer.

■ Trailer lights

- Please consult any authorized Lexus retailer or Lexus authorized repairer, or any reliable repairer when installing trailer lights, as incorrect installation may cause damage to the vehicle's lights. Please take care to comply with your state's laws when installing trailer lights.
- Check that the turn signal lights and stoplights are operating correctly every time you hitch up the trailer. Directly wiring up to your vehicle may damage the electrical system and stop the lights from functioning correctly.

■ Break-in schedule

Lexus recommends that vehicles fitted with new power train components should not be used for towing trailers for the first 800 km (500 miles).

■ Safety checks before towing

- Check that the maximum load limit for the towing hitch/bracket and hitch ball is not exceeded. Bear in mind that the coupling weight of the trailer will add to the load exerted on the vehicle. Also make sure that the total load exerted on the vehicle is within the range of the weight limits. (→P. 211)
- Ensure that the trailer load is secure.
- Supplementary outside rear view mirrors should be added to the vehicle if the traffic behind cannot be clearly seen with standard mirrors. Adjust the extending arms of these mirrors on both sides of the vehicle so that they always provide maximum visibility of the road behind.

■ Maintenance

- Maintenance must be performed more frequently when using the vehicle for towing due to the greater weight burden placed on the vehicle compared to normal driving.
- Retighten all bolts securing the hitching ball and bracket after towing for approximately 1000 km (600 miles).

NOTICE

■ When the rear bumper strengthening material is aluminum

Ensure the steel bracket part does not come directly in contact with that area. When steel and aluminum come into contact, there is a reaction similar to corrosion, which will weaken the section concerned and may result in damage. Apply a rust inhibitor to parts that will come in contact when attaching a steel bracket.

Guidance

Your vehicle will handle differently when towing a trailer. In order to avoid accident, death or serious injury, keep the following in mind when towing:

■ Checking connections between trailer and lights

Stop the vehicle and check the operation of the connection between the trailer and lights after driving for a brief period as well as before starting off.

■ Practicing driving with a coupled trailer

- Get the feel for turning, stopping and reversing with the trailer coupled by practicing in an area with no or light traffic.
- When reversing with a coupled trailer, hold the section of the steering wheel nearest to you and rotate clockwise to turn the trailer left or counter-clockwise to turn it right. Always rotate a little at a time to prevent steering error. Have someone guide you when reversing to lessen the risk of an accident.

■ Increasing vehicle-to-vehicle distance

At a speed of 10 km/h (6 mph), the distance to the vehicle running ahead of you should be equivalent to or greater than the combined length of your vehicle and trailer. Avoid sudden braking that may cause skidding. Otherwise, the vehicle may spin out of control. This is especially true when driving on wet or slippery road surfaces.

■ Sudden acceleration/steering input/cornering

Executing sharp turns when towing may result in the trailer colliding with your vehicle. Decelerate well in advance when approaching turns and take them slowly and carefully to avoid sudden braking.

■ Important points regarding turning

The wheels of the trailer will travel closer to the inside of the curve than the wheels of the vehicle. To make allowance for this, take the turns wider than you would normally do.

■ Important points regarding stability

Vehicle movement resulting from uneven road surfaces and strong crosswinds will affect handling. The vehicle may also be rocked by passing buses or large trucks. Frequently check behind when moving alongside such vehicles. As soon as such vehicle movement occurs, immediately start to decelerate smoothly by slowly applying the brakes. Always steer the vehicle straight ahead while braking.

■ Passing other vehicles

Consider the total combined length of your vehicle and trailer and ensure that the vehicle-to-vehicle distance is sufficient before executing lane changes.

■ Transmission information

To maintain engine braking efficiency, when using engine braking, when driving on a long steep downgrade, do not use the transmission in D. (→P. 227)

■ If the engine overheats

Towing a loaded trailer up a long, steep incline in temperatures exceeding 30°C (85°F) may result in the engine overheating. If the engine coolant temperature gauge indicates that the engine is overheating, turn the air conditioning off immediately, leave the road and stop the vehicle in a safe place. (→P. 535)

■ When parking the vehicle

Always place wheel chocks under the wheels of both the vehicle and trailer. Firmly set the parking brake and shift the shift lever to P.

WARNING

Follow all the instructions described in this section. Failure to do so could cause an accident resulting in death or serious injury.

■ Trailer towing precautions

When towing, make sure that none of the weight limits are exceeded. (→P. 211)

■ To avoid accident or injury

- Do not tow a trailer when the compact spare tire is installed on your vehicle.
- Do not tow a trailer when the tire installed is repaired with the emergency tire puncture repair kit.
- Do not use cruise control (if equipped) or dynamic radar cruise control with full-speed range (if equipped) when trailer towing.

■ Vehicle speed in towing

Observe the legal maximum speeds for trailer towing.

■ Before descending hills or long declines

Reduce speed and downshift. However, never downshift suddenly while descending steep or long downhill grades.

■ Operation of the brake pedal

Do not hold the brake pedal depressed often or for long periods of time. Doing so may result in the brake overheating or reduce braking effects.

**NOTICE****■ For vehicles with emergency tire puncture repair kit (if equipped)**

Do not tow anything if a tire that has been repaired using the emergency tire puncture repair kit is installed. The load on the tire may cause unexpected damage to the tire.

Power (ignition) switch

Performing the following operations when carrying the electronic key on your person starts the hybrid system or changes power switch modes.

Starting the hybrid system

- 1 Press the parking brake switch to check that the parking brake is set. (→P. 232)

Parking brake indicator will come on.

- 2 Check that the shift lever is in P.
- 3 Firmly depress the brake pedal.



will be displayed on the multi-information display.

If it is not displayed, the hybrid system cannot be started.

- 4 Press the power switch shortly and firmly.

When operating the power switch, one short, firm press is enough.

It is not necessary to press and hold the switch.

If the "READY" indicator turns on, the hybrid system will operate normally.

Continue depressing the brake pedal until the "READY" indicator is illuminated.

The hybrid system can be started from any power switch mode.

- 5 Check that the "READY" indicator is illuminated.

The vehicle will not move when the "READY" indicator is off.

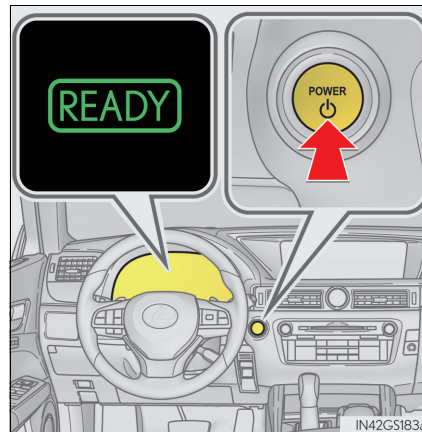

Stopping the hybrid system

- 1 Stop the vehicle completely.
- 2 Set the parking brake (→P. 232), and shift the shift lever to P.
- 3 Press the power switch.
- 4 Release the brake pedal and check that “POWER ON” on the multi-information display is off.

Changing power switch modes

Modes can be changed by pressing the power switch with brake pedal released. (The mode changes each time the switch is pressed.)

Off*

The emergency flashers can be used.
“POWER ON” will not be displayed on the multi-information display.

ACCESSORY mode

Some electrical components such as the audio system can be used.
“POWER ON” will be displayed on the multi-information display.

ON mode

All electrical components can be used.
“POWER ON” will be displayed on the multi-information display.

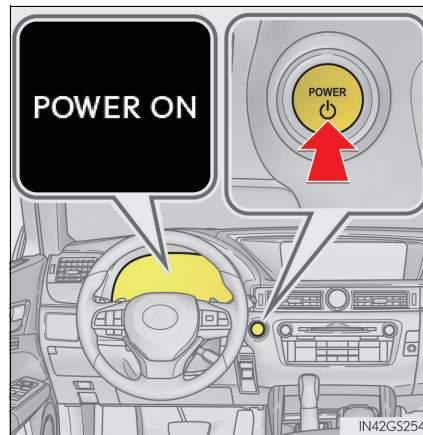

*: If the shift lever is in a position other than P when turning off the hybrid system, the power switch will be turned to ACCESSORY mode, not to off.

When stopping the hybrid system with the shift lever in a position other than P

If the hybrid system is stopped with the shift lever in a position other than P, the power switch will not be turned off but instead be turned to ACCESSORY mode. Perform the following procedure to turn the switch off:

- 1 Check that the parking brake is set.
- 2 Shift the shift lever to P.
- 3 Check that "Turn Off Vehicle" is displayed on the multi-information display and then press the power switch once.
- 4 Check that "Turn Off Vehicle" on the multi-information display is off.

■ Auto power off function

If the vehicle is left in ACCESSORY mode for more than 20 minutes or ON mode (the hybrid system is not operating) for more than an hour with the shift lever in P, the power switch will automatically turn off. However, this function cannot entirely prevent 12-volt battery discharge. Do not leave the vehicle with the power switch in ACCESSORY or ON mode for long periods of time when the hybrid system is not operating.

■ Sounds and vibrations specific to a hybrid vehicle

→P. 79

■ Electronic key battery depletion

→P. 136

■ When the ambient temperature is low, such as during winter driving conditions

When starting the hybrid system, the flashing time of the "READY" indicator may be long. Leave the vehicle as it is until the "READY" indicator is steady on, as steady means the vehicle is able to move.

■ Conditions affecting operation

→P. 155

■ Notes for the push-start function

→P. 157

■ If the hybrid system does not start

- The immobilizer system may not have been deactivated. (→P. 85)
Contact any authorized Lexus retailer or Lexus authorized repairer, or any reliable repairer.
- Check that the shift lever is securely set in P. The hybrid system may not start if the shift lever is displaced out of P. "Shift to P position to Start" will be displayed on the multi-information display.

■ Steering lock

After turning the power switch off and opening and closing the doors, the steering wheel will be locked due to the steering lock function. Operating the power switch again automatically cancels the steering lock.

■ **When the steering lock cannot be released**

“Steering Lock active” will be displayed on the multi-information display.

Check that the shift lever is set in P. Press the power switch while turning the steering wheel left and right.

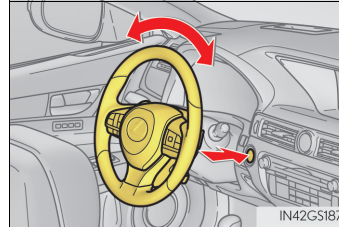

■ **Steering lock motor overheating prevention**

To prevent the steering lock motor from overheating, the motor may be suspended if the hybrid system is turned on and off repeatedly in a short period of time. In this case, refrain from operating the hybrid system. After about 10 seconds, the steering lock motor will resume functioning.

■ **When “Check Entry & Start System” will be displayed on the multi-information display**

The system may be malfunctioning. Have the vehicle inspected by any authorized Lexus retailer or Lexus authorized repairer, or any reliable repairer immediately.

■ **If the “READY” indicator does not come on**

In the event that the “READY” indicator does not come on even after performing the proper procedures for starting the vehicle, contact any authorized Lexus retailer or Lexus authorized repairer, or any reliable repairer immediately.

■ **If the hybrid system is malfunctioning**

→P. 466

■ **If the electronic key battery is depleted**

→P. 435

■ **Operation of the power switch**

- If the switch is not pressed shortly and firmly, the power switch mode may not change or the hybrid system may not start.
- If attempting to restart the hybrid system immediately after turning the power switch off, the hybrid system may not start in some cases. After turning the power switch off, please wait a few seconds before restarting the hybrid system.

■ **If the smart entry & start system has been deactivated in a customized setting**

→P. 527

 **WARNING****■ When starting the hybrid system**

Always start the hybrid system while sitting in the driver's seat. Do not depress the accelerator pedal while starting the hybrid system under any circumstances. Doing so may cause an accident resulting in death or serious injury.

■ Caution while driving

If hybrid system failure occurs while the vehicle is moving, do not lock or open the doors until the vehicle reaches a safe and complete stop. Activation of the steering lock in this circumstance may lead to an accident, resulting in death or serious injury.

■ Stopping the hybrid system in an emergency

If you want to stop the hybrid system in an emergency while driving the vehicle, press and hold the power switch for more than 2 seconds, or press it briefly 3 times or more in succession. (→P. 453)

However, do not touch the power switch while driving except in an emergency. Turning the hybrid system off while driving will not cause loss of steering or braking control, however, power assist to the steering will be lost. This will make it more difficult to steer smoothly, so you should pull over and stop the vehicle as soon as it is safe to do so.

 **NOTICE****■ To prevent 12-volt battery discharge**

- Do not leave the power switch in ACCESSORY or ON mode for long periods of time without the hybrid system on.
- If "POWER ON" is displayed on the multi-information display, the power switch is not off. Exit the vehicle after turning the power switch off.
- Do not stop the hybrid system when the shift lever is in a position other than P. If the hybrid system is stopped in another shift lever position, the power switch will not be turned off but instead be turned to ACCESSORY mode. If the vehicle is left in ACCESSORY mode, 12-volt battery discharge may occur.

■ When starting the hybrid system

If the hybrid system becomes difficult to start, have your vehicle checked by any authorized Lexus retailer or Lexus authorized repairer, or any reliable repairer immediately.

■ Symptoms indicating a malfunction with the power switch

If the power switch seems to be operating somewhat differently than usual, such as the switch sticking slightly, there may be a malfunction. Contact any authorized Lexus retailer or Lexus authorized repairer, or any reliable repairer immediately.

EV drive mode

In EV drive mode, electric power is supplied by the hybrid battery (traction battery), and only the electric motor (traction motor) is used to drive the vehicle.

This mode allows you to drive in residential areas early in the morning and late at night, or in indoor parking lots etc. without concern for noises and gas emissions.

Turns EV drive mode on/off

When EV drive mode is turned on, "EV MODE" will be displayed on the multi-information display. Pressing the switch when in EV drive mode will return the vehicle to normal driving (using the gasoline engine and electric motor [traction motor]).

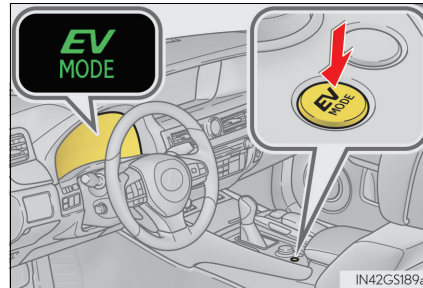

■ Situations in which EV drive mode cannot be turned on

It may not be possible to turn EV drive mode on in the following situations. If it cannot be turned on, a buzzer will sound and a message will be shown on the multi-information display.

- The temperature of the hybrid system is high.
The vehicle has been left in the sun, driven on a hill, driven at high speeds, etc.
- The temperature of the hybrid system is low.
The vehicle has been left in temperatures lower than about 0°C (32°F) for a long period of time etc.
- The gasoline engine is warming up.
- The hybrid battery (traction battery) is low.
The remaining battery level indicated in the "Energy monitor" display is low. (→P. 126)
- Vehicle speed is high.
- The accelerator pedal is depressed firmly or the vehicle is on a hill etc.
- The windshield defogger is in use.

■ Switching to EV drive mode when the gasoline engine is cold

If the hybrid system is started while the gasoline engine is cold, the gasoline engine will start automatically in order to warm up. In this case, you will become unable to switch to EV drive mode.

To prevent gasoline engine warm up in order to reduce noises, start the hybrid system without starting the gasoline engine, pressing the power switch with fully depressing the brake pedal and pressing the EV drive mode switch.

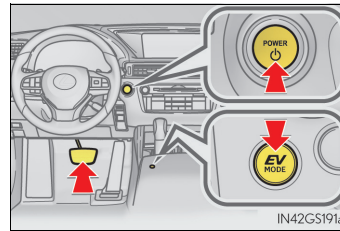

■ Automatic cancelation of EV drive mode

When driving in EV drive mode, the gasoline engine may automatically restart in the following situations. When EV drive mode is canceled, a buzzer will sound and the EV drive mode indicator will flash and go off.

- The hybrid battery (traction battery) becomes low.
The remaining battery level indicated in the "Energy monitor" display is low. (→P. 126)
- Vehicle speed is high.
- The accelerator pedal is depressed firmly or the vehicle is on a hill etc.

When it is possible to inform the driver of automatic cancelation in advance, a prior notice screen will appear on the multi-information display.

■ Possible driving distance when driving in EV drive mode

EV drive mode's possible driving distance ranges from a few hundred meters to approximately 1 km (0.6 mile). However, depending on vehicle conditions, there are situations when EV drive mode cannot be used.

(The distance that is possible depends on the hybrid battery [traction battery] level and driving conditions.)

■ Fuel economy

The hybrid system is designed to achieve the best possible fuel economy during normal driving (using the gasoline engine and electric motor [traction motor]). Driving in EV drive mode more than necessary may lower fuel economy.

⚠ WARNING

■ Caution while driving

When driving in EV drive mode, pay special attention to the area around the vehicle. Because there is no engine noise, pedestrians, people riding bicycles or other people and vehicles in the area may not be aware of the vehicle starting off or approaching them, so take extra care while driving.

Hybrid transmission

Shifting the shift lever

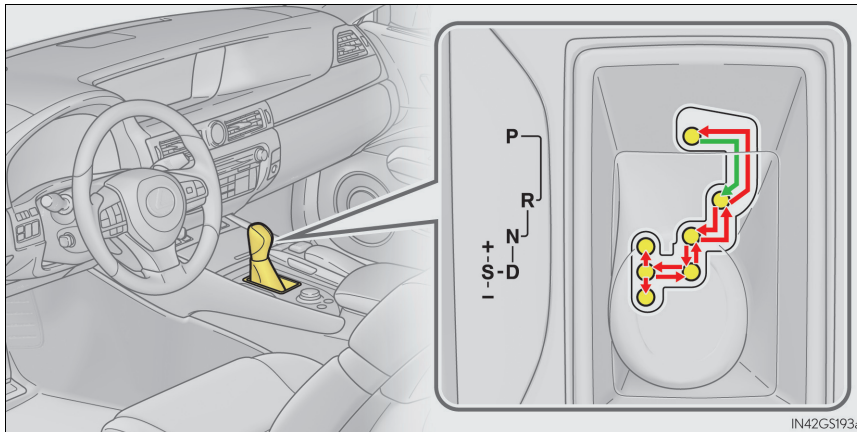

← While the power switch is in ON mode, move the shift lever with the brake pedal depressed.

When shifting the shift lever between P and D, make sure that the vehicle is completely stopped.

Shift position purpose

Shift position	Objective or function
P	Parking the vehicle/starting the hybrid system
R	Reversing
N	Neutral (Condition in which the power is not transmitted)
D	Normal driving ^{*1}
S	S mode driving ^{*2} (→P. 227)

^{*1}: To improve fuel efficiency and reduce noises, set the shift lever in D for normal driving.

^{*2}: By selecting shift ranges using S mode, you can control accelerating forces and engine braking forces.

Selecting the driving mode

■ Sport mode/Eco drive mode

→P. 311

■ Snow mode

Snow mode can be selected to suit the conditions when driving on slippery road surfaces, such as on snow.

Press the switch.

Press the switch again to return to normal mode.

*1: Except F SPORT models

*2: F SPORT models

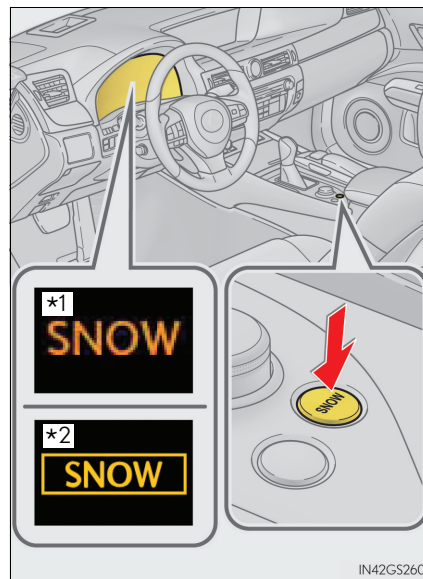

Selecting shift ranges in the D position

To drive using temporary shift range selection, operate the “-” or “+” paddle shift switch.

When the “-” paddle shift switch is operated, the shift range will be downshifted to a range that enables engine braking force that is suitable to driving conditions. When the “+” paddle shift switch is operated, the shift range will be one gear upper than the gear in use during normal D position driving.

Changing the shift range allows restriction of the highest shift range, preventing unnecessary upshifting and enabling the level of engine braking force to be selected.

- ① Upshifting
- ② Downshifting

GS450h:
The selected shift range, from D1 to D8, will be displayed in the meter.

GS300h:
The selected shift range, from D1 to D6, will be displayed in the meter.

To return to normal D position driving, the “+” paddle shift switch must be held down for a period of time.

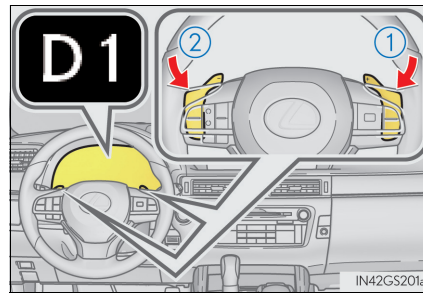

■ Shift ranges and their functions

Meter display		Function
GS450h	GS300h	
D2-D8	D2-D6	A gear in the range between D1 and the selected shift range is automatically chosen depending on vehicle speed and driving conditions
D1		Setting the shift range at D1

A lower shift range will provide greater engine braking forces than a higher shift range.

Selecting shift ranges in the S position

To enter S mode, shift the shift lever to S. Shift ranges can be selected by operating the shift lever or paddle shift switches, allowing you to drive in the shift range of your choosing.

- ① Upshifting
- ② Downshifting

GS450h:

The selected shift range, from S1 to S8, will be displayed in the meter.

The initial shift range in S mode is automatically set to between S2 and S6 according to vehicle speed.

GS300h:

The selected shift range, from S1 to S6, will be displayed in the meter.

The initial shift range in S mode is automatically set to between S2 and S5 according to vehicle speed.

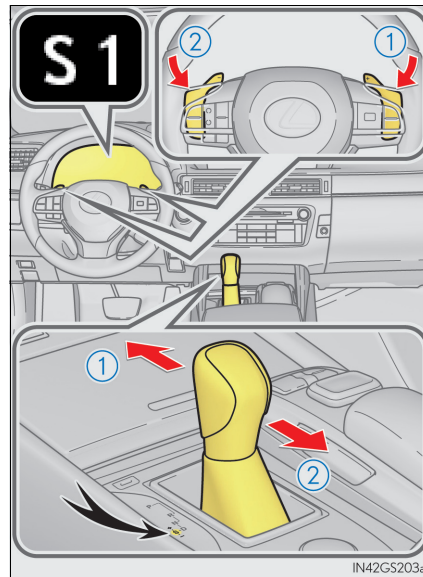

■ Shift ranges and their functions

- GS450h: You can choose from 8 levels of accelerating force and engine braking force.
GS300h: You can choose from 6 levels of accelerating force and engine braking force.
- A lower shift range will provide greater accelerating force and engine braking force than a higher shift range, and the engine revolutions will also increase.
- GS450h: If you accelerate while in ranges 1 to 7, the shift range may automatically range up in accordance with the vehicle's speed.
GS300h: If you accelerate while in ranges 1 to 5, the shift range may automatically range up in accordance with the vehicle's speed.

■ Automatic deactivation of shift range selection in the D position

Shift range selection in the D position will be deactivated in the following situations:

- When the vehicle comes to a stop
- If the accelerator pedal is depressed for more than a certain period of time
- When the shift lever is shifted to other than D

■ Downshifting restrictions warning buzzer

To help ensure safety and driving performance, downshifting operation may sometimes be restricted. In some circumstances, downshifting may not be possible even when the shift lever or paddle shift switch is operated. (A buzzer will sound twice.)

■ Snow mode automatic deactivation

Snow mode is automatically deactivated if the power switch is turned off after driving in snow mode.

■ When driving with cruise control or dynamic radar cruise control with full-speed range activated

Even when performing the following actions with the intent of enabling engine braking, engine braking will not activate because cruise control or dynamic radar cruise control with full-speed range will not be canceled.

- GS450h: While driving in the D position or S mode, downshifting to 7, 6, 5 or 4. (→P. 296, 308)
- GS300h: While driving in the D position, downshifting to 5 or 4. (→P. 296, 308)
- When switching the driving mode to sport mode while driving in D position. (→P. 311)

■ Restraining sudden start (Drive-Start Control)

- When the following unusual operation is performed, the engine output may be restrained.
 - When the shift lever is shifted from R to D, D to R, N to R, P to D, or P to R (D includes S) with the accelerator pedal depressed, a warning message appears on the multi-information display. (→P. 466)
 - When the accelerator pedal is depressed too much while the vehicle is in reverse.

■ Shift lock system

The shift lock system is a system to prevent accidental operation of the shift lever in starting.

The shift lever can be shifted from P only when the power switch is in ON mode and the brake pedal is being depressed.

■ If the shift lever cannot be shifted from P

First, check whether the brake pedal is being depressed.

If the shift lever cannot be shifted with your foot on the brake pedal, there may be a problem with the shift lock system. Have the vehicle inspected by any authorized Lexus retailer or Lexus authorized repairer, or any reliable repairer immediately.

The following steps may be used as an emergency measure to ensure that the shift lever can be shifted.

Releasing the shift lock:

- 1 Press the parking brake switch to check that the parking brake is set. (→P. 232)

Parking brake indicator will come on.

- 2 Turn the power switch to off.

- 3 Depress the brake pedal.

- 4 Pry the cover up with a flathead screwdriver or equivalent tool.

To prevent damage to the cover, cover the tip of the screwdriver with a rag.

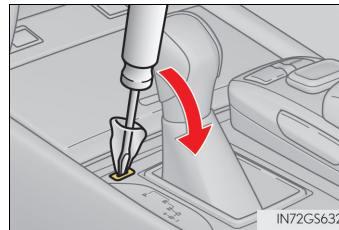

- 5 Press the shift lock override button.

The shift lever can be shifted while the button is pressed.

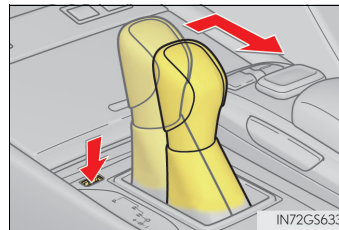

⚠ WARNING

■ When driving on slippery road surfaces

Be careful of downshifting and sudden acceleration, as this could result in the vehicle skidding to the side or spinning.

■ To prevent an accident when releasing the shift lock

Before pressing the shift lock override button, make sure to set the parking brake and depress the brake pedal.

If the accelerator pedal is accidentally depressed instead of the brake pedal when the shift lock override button is pressed and the shift lever is shifted out of P, the vehicle may suddenly start, possibly leading to an accident resulting in death or serious injury.

 NOTICE

■ **Hybrid battery (traction battery) charge**

If the shift lever is in N, the hybrid battery (traction battery) will not be charged even when the engine is running. Therefore, if the vehicle is left with the shift lever in N for a long period of time, the hybrid battery (traction battery) will discharge, and this may result in the vehicle not being able to start.

Turn signal lever

Operating instructions

The lever will return to its original position immediately after operation.

- ① Right turn
- ② Lane change to the right (move the lever partway and release it)
The right hand signals will flash 3 times.
- ③ Lane change to the left (move the lever partway and release it)
The left hand signals will flash 3 times.
- ④ Left turn

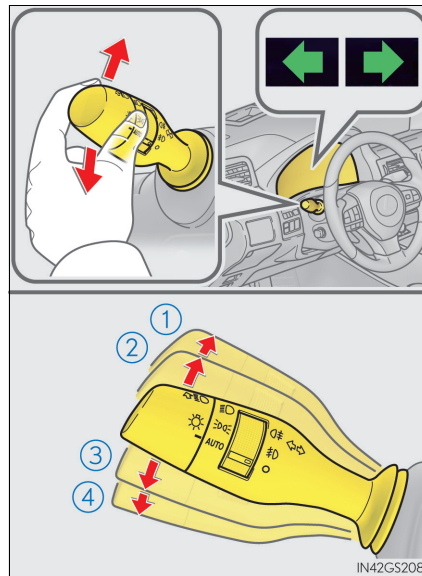

■ **If the turn signals do not stop flashing after turning left or right, or if you want to stop them flashing**

Operate the lever in the opposite direction to either position ② or ③.

If you move the lever to either position ① or ④, the selected turn signals will flash.

■ **Turn signals can be operated when**

The power switch is in ON mode.

■ **If the indicator flashes faster than usual**

Check that a light bulb in the front or rear turn signal lights has not burned out.

■ **If the turn signals stop flashing before a lane change has been performed**

Operate the lever again.

Parking brake

A selections can be made as desired from the following modes.

Manual mode

- ① Sets the parking brake

The parking brake indicator light will come on. (→P. 233)

Press and hold the parking brake switch if an emergency occurs and it is necessary to operate the parking brake while driving.
- ② Releases the parking brake

Operate the parking brake switch while depressing the brake pedal. Make sure that the parking brake indicator light goes off.

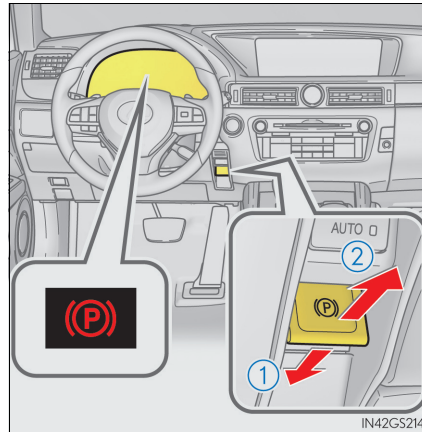

Automatic mode

The parking brake is set or released automatically according to shift lever operation.

Turns automatic mode on/off

- When the shift lever is moved out of P, the parking brake will be released.
- When the shift lever is moved into P, the parking brake will be set.

Operate the shift lever with the brake pedal depressed.

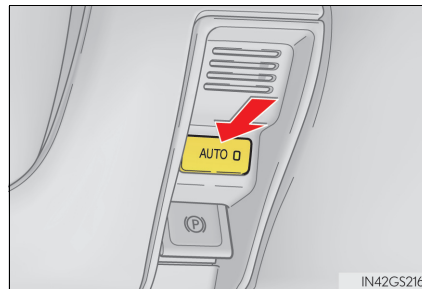

■ Parking brake operation

- When the power switch is not in ON mode, the parking brake cannot be released using the parking brake switch.
- When the power switch is not in ON mode, automatic mode (automatic brake setting and releasing) is not available.
- If the parking brake is operated repeatedly over a short period of time, the system may restrict operation to prevent overheating. If this happens, refrain from operating the parking brake. Normal operation will return after about 1 minute.
- Vehicles with towing package: In situations such as when parking while towing a trailer, the maximum amount of braking force can be used by pressing the parking brake switch with the parking brake already set.
- Vehicles without towing package: In situations such as when parking on a steep slope^{*}, the maximum amount of braking force can be used by pressing the parking brake switch with the parking brake already set.

*: Use wheel chocks when parking on a steep slope.

■ Parking brake operation sound

When the parking brake operates, a motor sound (whirring sound) may be heard. This does not indicate a malfunction.

■ Parking brake indicator light

- Depending on the power switch mode, the parking brake indicator light will come on and stay on as described below:
 - ON mode: Comes on until the parking brake is released.
 - Not in ON mode: Stays on for approximately 15 seconds.
- When the power switch is turned off with the parking brake set, the parking brake indicator light will stay on for about 15 seconds. This does not indicate a malfunction.

■ When there is a malfunction in the system

Warning lights and/or warning message will turn on or flash. (→P. 462, 466)
Depending on the condition, the parking brake indicator light may flash.

■ Parking the vehicle

→P. 200

■ Parking brake engaged warning buzzer

→P. 472

■ Usage in winter time

→P. 334



NOTICE

■ **When parking the vehicle**

Before you leave the vehicle, set the parking brake, shift the shift lever to P and make sure that the vehicle does not move.

■ **When the system malfunctions**

Stop the vehicle in a safe place and check the warning messages.

■ **When the parking brake cannot be released due to a malfunction**

Use the parking brake release tool to manually release the parking brake. (→P. 525)
Driving the vehicle with the parking brake set will lead to brake components overheating, which may affect braking performance and increase brake wear.

Brake Hold

The brake hold system keeps the brake applied when the shift lever is in D, S or N with the system on and the brake pedal has been depressed to stop the vehicle. The system releases the brake when the accelerator pedal is depressed with the shift lever in D or S to allow smooth start off.

Turns the brake hold system on

The brake hold standby indicator (green) comes on. While the system is holding the brake, the brake hold operated indicator (yellow) comes on.

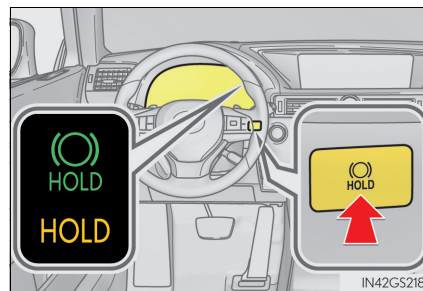

■ Brake hold system operating conditions

The brake hold system cannot be turned on in the following conditions:

- The driver's door is not closed.
- The driver is not wearing the seat belt.
- "EPB Activation Stopped Incompletely" or "Electronic Parking Brake Malfunction Visit Your Dealer" is displayed on the multi-information display.

If any of the conditions above are detected when the brake hold system is enabled, the system will turn off and the brake hold standby indicator light will go off. In addition, if any of the conditions are detected while the system is holding the brake, a warning buzzer will sound and a message will be shown on the multi-information display. The parking brake will then be set automatically.

■ Brake hold function

- If the brake pedal is left released for a period of about 3 minutes after the system has started holding the brake, the parking brake will be set automatically. In this case, a warning buzzer sounds and a message is shown on the multi-information display.
- To turn the system off while the system is holding the brake, firmly depress the brake pedal and press the button again.
- The brake hold function may not hold the vehicle when the vehicle is on a steep incline. In this situation, it may be necessary for the driver to apply the brakes. A warning buzzer will sound and the multi-information display will inform the driver of this situation. (→P. 466)

■ **When the parking brake is set automatically while the system is holding the brakes**

The parking brake will not be released automatically. Perform one of the following procedures to release the parking brake and confirm that the parking brake indicator light turns off. (→P. 232)

- With the brake pedal depressed, operate the parking brake switch.
- Fasten your seat belt, check that the shift lever is in either D or R and slowly depress the accelerator pedal.

■ **Warning message and buzzers**

Warning messages and buzzers are used to indicate a system malfunction or to inform the driver of the need for caution. (→P. 466)

 **WARNING**

■ **When the vehicle is on a steep incline**

When using the brake hold system on a steep incline exercise caution. The brake hold function may not hold the vehicle in such a situation.

■ **When stopped on a slippery road**

The system cannot stop the vehicle when the gripping ability of the tires has been exceeded. Do not use the system when stopped on a slippery road.

 **NOTICE**

■ **When parking the vehicle**



The brake hold system is not designed for use when parking the vehicle for a long period of time. Turning the power switch off while the system is holding the brake may release the brake, which would cause the vehicle to move. When operating the power switch, depress the brake pedal, set the parking brake and shift the shift lever to P.

Headlight switch

The headlights can be operated manually or automatically.

Operating instructions

Turning the end of the lever turns on the lights as follows:

- ①  The front position, tail, license plate and instrument panel lights turn on.
- ②  The headlights and all lights listed above turn on.
- ③ **AUTO** The headlights, daytime running lights (→P. 240) and all the lights listed above turn on and off automatically. (When the power switch is in ON mode.)

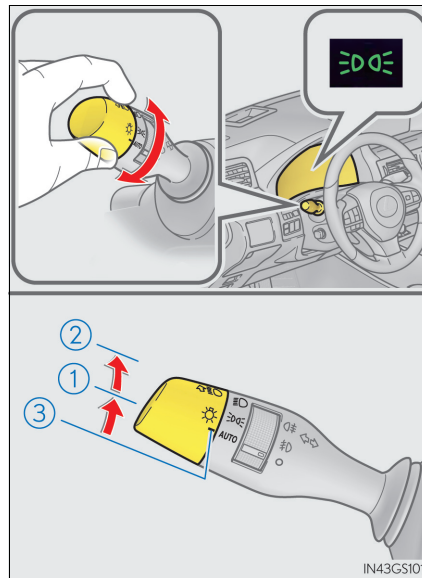

Turning on the high beam headlights

- ① With the headlights on, push the lever away from you to turn on the high beams.

Pull the lever toward you to the center position to turn the high beams off.

- ② Pull the lever toward you and release it to flash the high beams once.

You can flash the high beams with the headlights on or off.

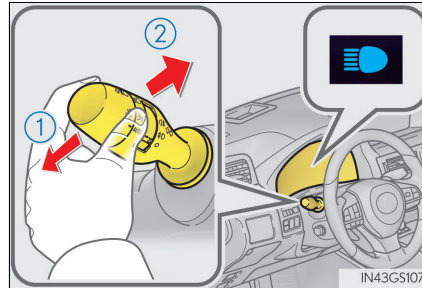

Follow me home system

This system allows the headlights and front position lights to be turned on for 30 seconds when the power switch is off.

Pull the lever toward you and release it with the light switch is in **AUTO** after turning the power switch off.

Pull the lever toward you and release it again to turn off the lights.

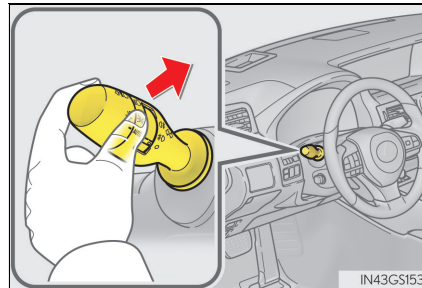



AFS (Adaptive Front-lighting System) (if equipped)

AFS (Adaptive Front-lighting System) secures excellent visibility at intersections and on curves by automatically adjusting the direction of the light axis of the headlights according to vehicle speed and the degree of the tire's angle as controlled by steering input.

AFS operates at speeds of 10 km/h (6 mph) or higher.

■ Deactivating AFS

Settings can be changed from  on the multi-information display (→P. 111).

- 1 Press  or  on the meter control switch and select "AFS".
- 2 Press  on the meter control switch and select "Off".

The indicator turns on when the AFS is deactivated.

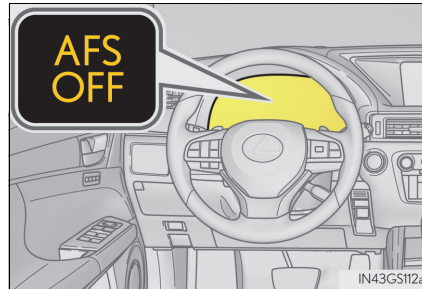

■ **Daytime running light system**

To make your vehicle more visible to other drivers during daytime driving, the daytime running lights turn on automatically whenever the hybrid system is started and the parking brake is released with the headlight switch is in the "AUTO" position. (Illuminate brighter than the front position lights.)

Daytime running lights are not designed for use at night.

■ **Headlight control sensor**

The sensor may not function properly if an object is placed on the sensor, or anything that blocks the sensor is affixed to the windshield. Doing so interferes with the sensor detecting the level of ambient light and may cause the automatic headlight system to malfunction.

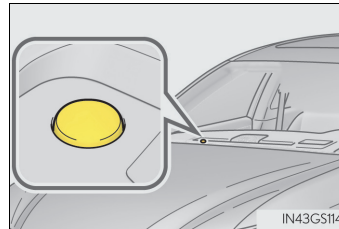

■ **Automatic light off system**

- When the light switch is in $\equiv D$: The headlights turn off automatically if the power switch is turned to ACCESSORY mode or turned off.

- When the light switch is in AUTO: The headlights and all lights turn off automatically if the power switch is turned to ACCESSORY mode or turned off.

To turn the lights on again, turn the power switch to ON mode, or turn the light switch off once and then back to $\equiv \text{OFF}$ or $\equiv D$.

■ **Light reminder buzzer**

A buzzer sounds when the power switch is turned off or turned to ACCESSORY mode and the driver's door is opened while the lights are turned on.

■ **Automatic headlight leveling system**

The level of the headlights is automatically adjusted according to the number of passengers and the loading condition of the vehicle to ensure that the headlights do not interfere with other road users.

■ **If the "AFS OFF" indicator flashes**

It may indicate a malfunction in the system. Contact any authorized Lexus retailer or Lexus authorized repairer, or any reliable repairer.

■ **Customization**

Settings (e.g. light sensor sensitivity) can be changed. (Customizable features: →P. 568)

 **NOTICE**

■ **To prevent 12-volt battery discharge**

Do not leave the lights on longer than necessary when the hybrid system is off.

AHS (Adaptive High-beam System)*

The Adaptive High-beam System uses a camera sensor located behind the upper portion of the windshield to assess the brightness of the lights of vehicles ahead, streetlights, etc., and automatically controls the headlight light distribution as necessary.

- Adjusts the brightness and illuminated area of the high beams according to the vehicle speed.
- Adjusts the intensity of the high beams, while driving on a curve, so that the area in the direction that the vehicle is turning will be illuminated more brightly than other areas.
- Operates the variable high beams so that the area around vehicles ahead is partially not illuminated while all other areas continue to be illuminated with the high beams.

The variable high beams help optimize forward visibility while reducing the dazzling effect on the drivers of vehicles ahead.

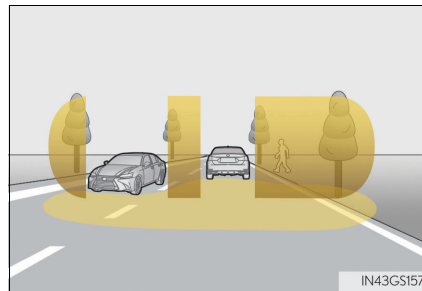

- Adjusts the distance that the low beams are projected according to the distance to a preceding vehicle.

WARNING

■ Limitations of the Adaptive High-beam System

Do not rely on the Adaptive High-beam System. Always drive safely, taking care to observe your surroundings and turning the high beam on or off manually if necessary.

■ To prevent incorrect operation of the Adaptive High-beam system

Do not overload the vehicle.

*: If equipped

Activating the Adaptive High-beam System

- 1 Push the lever away from you with the headlight switch in the  or AUTO position.

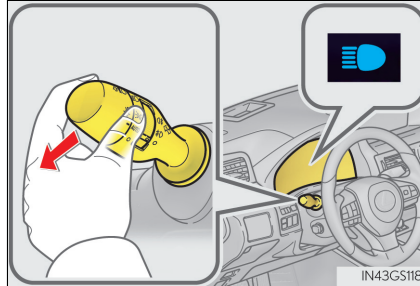

- 2 Press the Adaptive High-beam System switch.

The Adaptive High-beam System indicator will come on when the headlights are turned on automatically to indicate that the system is active.

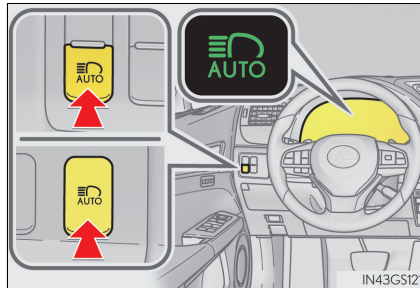

Turning the high beam on/off manually

■ Switching to low beam

Pull the lever to the original position.

The Adaptive High-beam System indicator will turn off.

Push the lever away from you to activate the Adaptive High-beam System again.

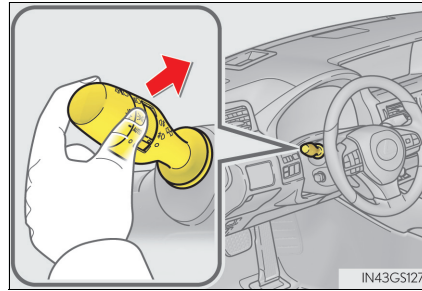

■ Switching to high beam

Press the Adaptive High-beam System switch.

The Adaptive High-beam System indicator will turn off and the high beam indicator will turn on.

Press the switch to activate the Adaptive High-beam System again.

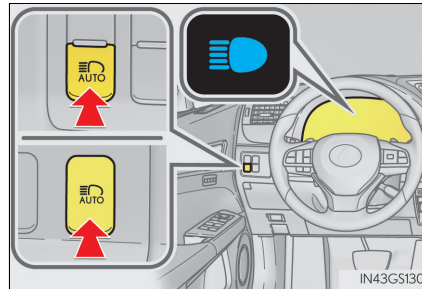

■ Conditions in which the light distribution control of the headlights changes automatically

- When all of the following conditions are met, the high beams will be turned on automatically and the system will operate:

- The vehicle speed is approximately 60 km/h (37 mph) or more. *

*: The area in the direction that the vehicle is turning will be illuminated more brightly than other areas while driving on a curve.

- When all of the following conditions are met, the variable high beams will turn on and the distance that the low beams are projected will be adjusted automatically, depending on the location of vehicles ahead:

- The vehicle speed is approximately 60 km/h (37 mph) or more.
- The area ahead of the vehicle is dark.
- There are vehicles ahead with headlights or tail lights turned on.

- If any of the following conditions is met, the high beams or variable high beams will be changed to the low beams automatically:

- The vehicle speed is below approximately 60 km/h (37 mph).
- The area ahead of the vehicle is not dark.
- There are many vehicles ahead.
- Vehicles ahead are moving quickly and the high beams may blind the drivers of the other vehicles.

■ Camera sensor detection information

- The high beams may not be automatically changed to the variable high beams in the following situations:

- When vehicles ahead suddenly appear from a curve
- When the vehicle is cut in front of by another vehicle
- When vehicles ahead are hidden from sight due to repeated curves, road dividers or roadside trees
- When vehicles ahead appear from the faraway lane on wide road
- When vehicles ahead have no lights

- The high beams may be changed to the variable high beams if a vehicle ahead that is using fog lights without its headlights turned on is detected.

- House lights, street lights, traffic signals, and illuminated billboards or signs may cause the high beams to change to the variable high beams, cause the high beams not to change to the variable high beams, or change the area that is not illuminated.

- The following factors may affect the amount of time taken to turn the high beam on or off, or the speed by which the areas not illuminated change:

- The brightness of headlights, fog lights, and tail lights of vehicles ahead
- The movement and direction of vehicles ahead
- When a vehicle ahead only has operational lights on one side
- When a vehicle ahead is a two-wheeled vehicle
- The condition of the road (gradient, curve, condition of the road surface etc.)
- The number of passengers and amount of luggage

- The light distribution control of the headlights may change unexpectedly.

- Bicycles or similar objects may not be detected.

- In the situations shown below, the system may not be able to accurately detect surrounding brightness levels. This may cause the low beams to remain on or the high beams to cause problems for pedestrians, vehicles ahead or other parties. In these cases, manually switch between the high and low beams.
 - In bad weather (rain, snow, fog, sandstorms etc.)
 - The windshield is obscured by fog, mist, ice, dirt etc.
 - The windshield is cracked or damaged.
 - The camera sensor is deformed or dirty.
 - The camera sensor temperature is extremely high.
 - Surrounding brightness levels are equal to those of headlights, tail lights or fog lights.
 - Vehicles ahead have headlights that are either switched off, dirty, are changing color, or are not aimed properly.
 - The vehicle is hit by water, snow, dust, etc. from a preceding vehicle.
 - When driving through an area of intermittently changing brightness and darkness.
 - When frequently and repeatedly driving ascending/descending roads, or roads with rough, bumpy or uneven surfaces (such as stone-paved roads, gravel tracks etc.).
 - When frequently and repeatedly taking curves or driving on a winding road.
 - There is a highly reflective object ahead of the vehicle, such as a sign or a mirror.
 - The back of a vehicle ahead is highly reflective, such as a container on a truck.
 - The vehicle's headlights are damaged or dirty.
 - The vehicle is listing or tilting, due to a flat tire, a trailer being towed etc.
 - The high beam and low beam are repeatedly being switched between in an abnormal manner.
 - The driver believes that the high beam may be causing problems or distress to other drivers or pedestrians nearby.

■ **Warning message**

Warning messages are used to indicate a system malfunction or to inform the driver of the need for caution. (→P. 466)

■ **Customization**

Some functions can be customized. (→P. 561)

Automatic High Beam *

The Automatic High Beam uses an in-vehicle camera sensor to assess the brightness of streetlights, the lights of vehicles ahead, etc., and automatically turns the high beam on or off as necessary.

⚠ WARNING

■ **Limitations of the Automatic High Beam**

Do not rely on the Automatic High Beam. Always drive safely, taking care to observe your surroundings and turning the high beam on or off manually if necessary.

■ **To prevent incorrect operation of the Automatic High Beam system**

Do not overload the vehicle.

Activating the Automatic High Beam system

- 1 Push the lever away from you with the headlight switch in the AUTO or  position.

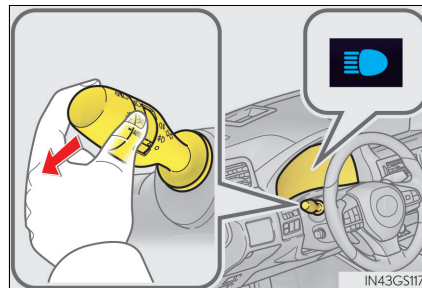

- 2 Press the Automatic High Beam switch.

The Automatic High Beam indicator will come on when the headlights are turned on automatically to indicate that the system is active.

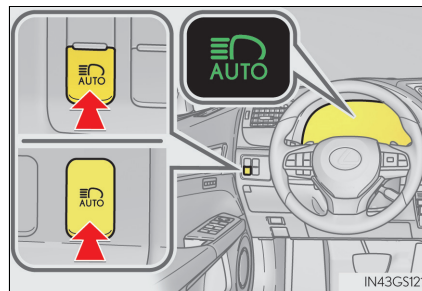

*: If equipped

Turning the high beam on/off manually

■ Switching to low beam

Pull the lever to the original position.

The Automatic High Beam indicator will turn off.

Push the lever away from you to activate the Automatic High Beam system again.

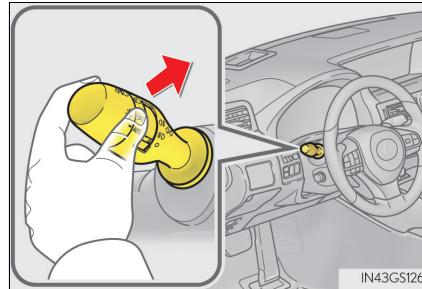

■ Switching to high beam

Press the Automatic High Beam switch.

The Automatic High Beam indicator will turn off and the high beam indicator will turn on.

Press the switch to activate the Automatic High Beam system again.

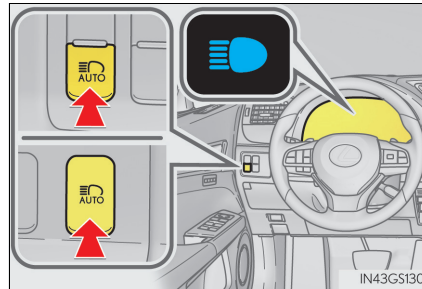

■ High beam automatic turning on or off conditions

- When all of the following conditions are fulfilled, the high beam will be automatically turned on (after approximately 1 second):
 - Vehicle speed is above approximately 40 km/h (25 mph).
 - The area ahead of the vehicle is dark.
 - There are no vehicles ahead with headlights or tail lights turned on.
 - There are few streetlights on the road ahead.
- If any of the following conditions are fulfilled, the high beam will be automatically turned off:
 - Vehicle speed drops below approximately 30 km/h (19 mph).
 - The area ahead of the vehicle is not dark.
 - Vehicles ahead have headlights or tail lights turned on.
 - There are many streetlights on the road ahead.

■ Camera sensor detection information

- The high beam may not be automatically turned off in the following situations:
 - When oncoming vehicles suddenly appear from a curve
 - When the vehicle is cut in front of by another vehicle
 - When vehicles ahead are hidden from sight due to repeated curves, road dividers or roadside trees
 - When vehicles ahead appear from the faraway lane on wide road
 - When vehicles ahead have no lights
- The high beam may be turned off if a vehicles ahead that is using fog lights without using the headlights is detected.
- House lights, street lights, traffic signals, and illuminated billboards or signs may cause the high beam to switch to the low beams, or the low beams to remain on.
- The following factors may affect the amount of time taken to turn the high beam on or off:
 - The brightness of headlights, fog lights, and tail lights of vehicles ahead
 - The movement and direction of vehicles ahead
 - When vehicle ahead only has operational lights on one side
 - When vehicle ahead is a two-wheeled vehicle
 - The condition of the road (gradient, curve, condition of the road surface etc.)
 - The number of passengers and amount of luggage
- The high beam may be turned on or off when the driver does not expect it.
- Bicycles or similar objects may not be detected.

- In the situations shown below, the system may not be able to accurately detect surrounding brightness levels. This may cause the low beams to remain on or the high beams to cause problems for pedestrians, vehicles ahead or other parties. In these cases, manually switch between the high and low beams.
 - In bad weather (rain, snow, fog, sandstorms etc.)
 - The windshield is obscured by fog, mist, ice, dirt etc.
 - The windshield is cracked or damaged.
 - The inside rear view mirror or camera sensor is deformed or dirty.
 - The camera sensor temperature is extremely high.
 - Surrounding brightness levels are equal to those of headlights, tail lights or fog lights.
 - Vehicles ahead have headlights that are either switched off, dirty, are changing color, or are not aimed properly.
 - When driving through an area of intermittently changing brightness and darkness.
 - When frequently and repeatedly driving ascending/descending roads, or roads with rough, bumpy or uneven surfaces (such as stone-paved roads, gravel tracks etc.).
 - When frequently and repeatedly taking curves or driving on a winding road.
 - There is a highly reflective object ahead of the vehicle, such as a sign or a mirror.
 - The back of a vehicle ahead is highly reflective, such as a container on a truck.
 - The vehicle's headlights are damaged or dirty.
 - The vehicle is listing or tilting, due to a flat tire, a trailer being towed etc.
 - The high beam and low beam are repeatedly being switched between in an abnormal manner.
 - The driver believes that the high beam may be causing problems or distress to other drivers or pedestrians nearby.
 - When going through the Straits of Dover.

■ **Warning message**

Warning messages are used to indicate a system malfunction or to inform the driver of the need for caution. (→P. 466)

Fog light switch

The fog lights secure excellent visibility in difficult driving conditions, such as in rain and fog.

- ① ○ Turns the front and rear fog lights off
- ② ☰ Turns the front fog lights on
- ③ ☷ Turns both front and rear fog lights on

Releasing the switch ring returns it to ☰.

Operating the switch ring again turns only the rear fog light off.

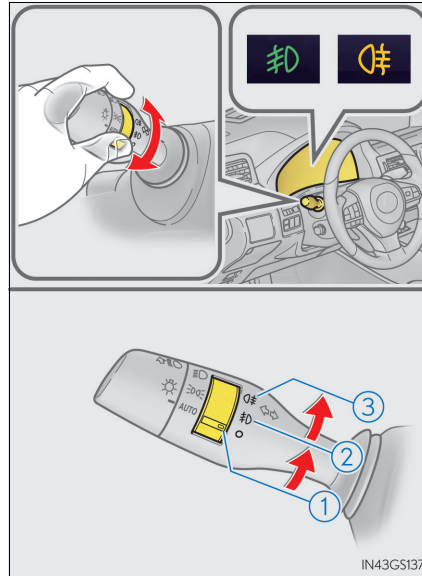

■ Fog lights can be used when

Front fog lights: The headlights or the front position lights are turned on.

Rear fog light: The front fog lights are turned on.

Windshield wipers and washer

Operating the wiper lever

Operate the lever as follows to operate the wipers. The lever will return to its original position immediately after operation.

► Intermittent windshield wipers with interval adjuster

- ① ○ Move the lever up 2 levels
- ② △ Move the lever up 1 level
- ③ ▽ Move the lever down 1 level
- ④ ≡ Move the lever down 2 levels

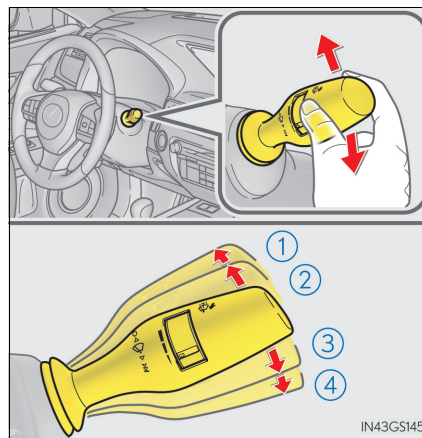

Operation Status before operation	○	△	▽	≡
Off	Temporary operation	Temporary operation	Intermittent operation	High speed operation
Intermittent operation	Off	Off	Low speed operation	High speed operation
Low speed operation	Off	Intermittent operation	High speed operation	High speed operation
High speed operation	Off	Low speed operation	No change	No change

252 4-3. Operating the lights and wipers

Wiper intervals can be adjusted when intermittent operation is selected.

- ⑤ Increases the intermittent windshield wiper frequency
- ⑥ Decreases the intermittent windshield wiper frequency

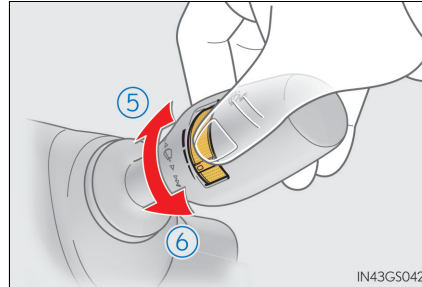

- ⑦ Washer/wiper dual operation

Wipers will automatically operate a couple of times after the washer squirts.

When the headlights are on and the lever is pulled and held, the headlight cleaners will operate once. After this, the headlight cleaners will operate every 5th time the lever is pulled.

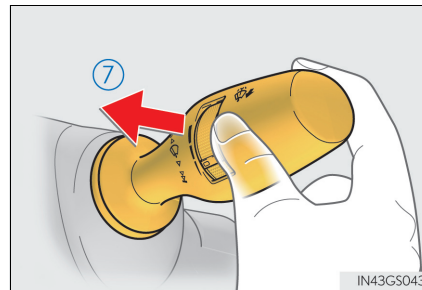

► Rain-sensing windshield wipers

- ① ○ Move the lever up 2 levels
- ② ▲ Move the lever up 1 level
- ③ ▼ Move the lever down 1 level
- ④ ≡ Move the lever down 2 levels
- ⑤  AUTO mode on/off switch

With AUTO mode selected, the wipers will operate automatically when the sensor detects falling rain. The system automatically adjusts wiper timing in accordance with rain volume and vehicle speed.

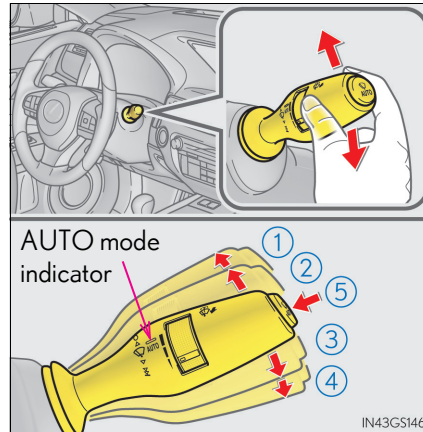

AUTO mode indicator will turn on when AUTO mode is selected.

Status before operation \ Operation		Operation			
		○	▲	▼	≡
Off		Temporary operation	Temporary operation	Low speed operation	High speed operation
Low speed operation		Off	Off	High speed operation	High speed operation
High speed operation		Off	Low speed operation	No change	No change
AUTO mode	Intermittent operation	Off	Temporary operation*1	Low speed operation*2	High speed operation*2
	Continuously		No change		

*1: After temporary operation, the mode will return to AUTO mode.

*2: AUTO mode will be canceled.

When AUTO mode is selected, the sensor sensitivity can be adjusted by turning the switch ring.

- ⑥ Increases the sensitivity
- ⑦ Decreases the sensitivity

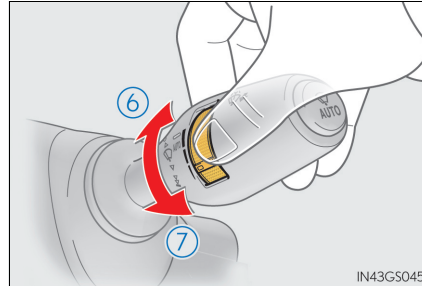

- ⑧ Washer/wiper dual operation
Wipers will automatically operate a couple of times after the washer squirts. When the headlights are on and the lever is pulled and held, the headlight cleaners will operate once. After this, the headlight cleaners will operate every 5th time the lever is pulled.

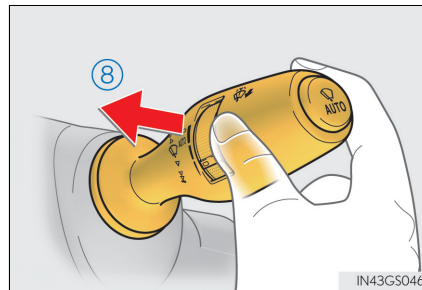

Switching between the intermittent windshield wipers and rain-sensing windshield wipers (vehicles with rain-sensing windshield wipers)

The wipers can be used as intermittent windshield wipers, which operate regardless of vehicle speed or amount of raindrops. The intermittent windshield wiper operation can be switched when the vehicle is stopped and the wiper is off. The wiper operation cannot be switched during AUTO mode or while the intermittent windshield wipers are operating.

Press and hold  AUTO until the AUTO mode indicator stops flashing.

If  AUTO is pressed and held until the AUTO mode indicator stops flashing again, it will return to its previous state.

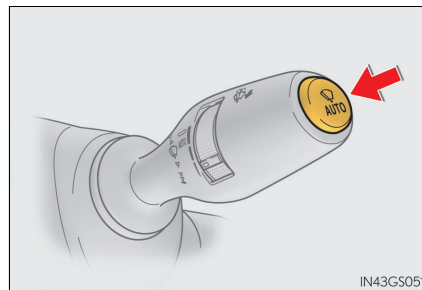

■ **The windshield wiper and washer can be operated when**

The power switch is in ON mode.

■ **Dripping prevention wiper sweep**

After washing and wiping operation several times, the wipers operate one more time after a short delay to prevent dripping.

However, the last sweep will not happen while the vehicle is moving.

■ **Effects of vehicle speed on wiper operation**

- Intermittent windshield wipers interval changes when the vehicle is stopped.
- With low speed operation selected, wiper operation will be switched from low speed to intermittent operation only when the vehicle is stationary.

■ **Raindrop sensor (vehicles with rain-sensing windshield wipers)**

- The raindrop sensor judges the amount of raindrops.

An optical sensor is adopted. It may not operate properly when sunlight from the rising or setting of the sun intermittently strikes the windshield, or if bugs etc. are present on the windshield.

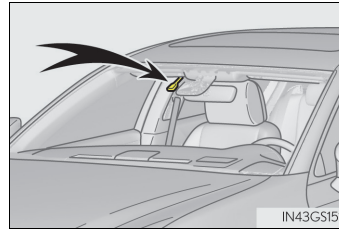

- If AUTO mode is selected while the power switch is in ON mode, the wipers will operate once to show that AUTO mode is activated.
- If the temperature of the raindrop sensor is 85°C (185°F) or higher, or -30°C (-22°F) or lower, automatic operation may not occur. In this case, operate the wipers in any mode other than AUTO mode.

■ **When the windshield wipers are in temporary operation**

AUTO mode cannot be activated even if  is pressed.

■ **If no windshield washer fluid sprays**

Check that the washer nozzles are not blocked if there is washer fluid in the windshield washer fluid reservoir.

 **WARNING**

■ **Caution regarding the use of windshield wipers in AUTO mode**

The windshield wipers may operate unexpectedly if the sensor is touched or the windshield is subject to vibration in AUTO mode. Take care that your fingers or anything else do not become caught in the windshield wipers.

■ **Caution regarding the use of washer fluid**

When it is cold, do not use the washer fluid until the windshield becomes warm. The fluid may freeze on the windshield and cause low visibility. This may lead to an accident, resulting in death or serious injury.

 NOTICE

- **When the windshield is dry**
Do not use the wipers, as they may damage the windshield.
- **When there is no washer fluid spray from the nozzle**
Damage to the washer fluid pump may be caused if the lever is pulled toward you and held continually.
- **When a nozzle becomes blocked**
In this case, contact any authorized Lexus retailer or Lexus authorized repairer, or any reliable repairer.
Do not try to clear it with a pin or other object. The nozzle will be damaged.
- **When standing the windshield wipers up**
Raise the wipers in line with the windshield. (→P. 337)
Failure to do so may result in damage to the wipers and/or the hood.

Opening the fuel tank cap

Perform the following steps to open the fuel tank cap:

Before refueling the vehicle

- Turn the power switch off and ensure that all the doors and windows are closed.
- Confirm the type of fuel.

■ Fuel types

→P. 559

■ Fuel tank opening for unleaded gasoline

To help prevent incorrect fueling, your vehicle has a fuel tank opening that only accommodates the special nozzle on unleaded fuel pumps.

WARNING

■ When refueling the vehicle

Observe the following precautions while refueling the vehicle. Failure to do so may result in death or serious injury.

- After exiting the vehicle and before opening the fuel door, touch an unpainted metal surface to discharge any static electricity. It is important to discharge static electricity before refueling because sparks resulting from static electricity can cause fuel vapors to ignite while refueling.
- Always hold the grips on the fuel tank cap and turn it slowly to remove it. A whooshing sound may be heard when the fuel tank cap is loosened. Wait until the sound cannot be heard before fully removing the cap. In hot weather, pressurized fuel may spray out the filler neck and cause injury.
- Do not allow anyone that has not discharged static electricity from their body to come close to an open fuel tank.
- Do not inhale vaporized fuel. Fuel contains substances that are harmful if inhaled.
- Do not smoke while refueling the vehicle. Doing so may cause the fuel to ignite and cause a fire.
- Do not return to the vehicle or touch any person or object that is statically charged. This may cause static electricity to build up, resulting in a possible ignition hazard.

■ When refueling

Observe the following precautions to prevent fuel overflowing from the fuel tank:

- Securely insert the fuel nozzle into the fuel filler neck.
- Stop filling the tank after the fuel nozzle automatically clicks off.
- Do not top off the fuel tank.



NOTICE

■ **Refueling**

Do not spill fuel during refueling.

Doing so may damage the vehicle, such as causing the emission control system to operate abnormally or damaging fuel system components or the vehicle's painted surface.

Opening the fuel tank cap

- 1 With the doors unlocked, press the center of the rear edge of the fuel filler door.

Push until you hear a click and take your hand away to slightly open the fuel filler door. Then open the door fully by hand.

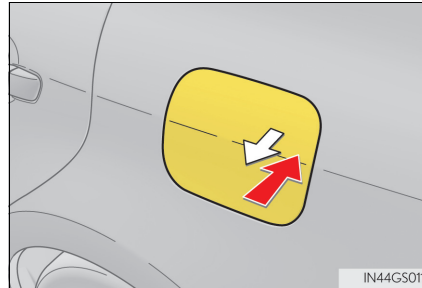

- 2 Turn the fuel tank cap slowly to remove it and put it into the holder on the fuel filler door.

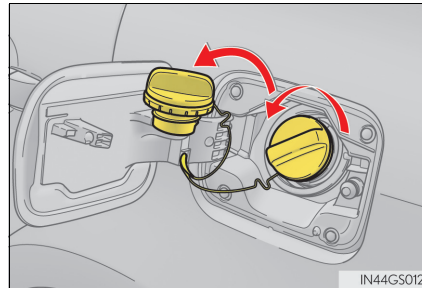

- When the fuel filler door cannot be opened by pressing the rearward of the fuel filler door

Remove the cover inside the trunk and pull the lever.

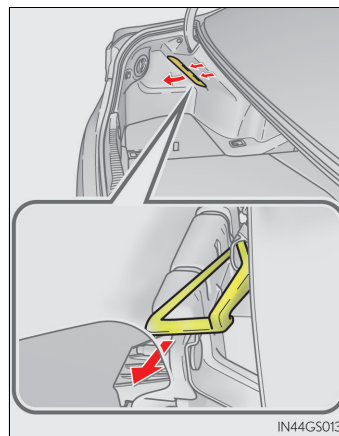

Closing the fuel tank cap

- 1 After refueling, turn the fuel tank cap until you hear a click. Once the cap is released, it will turn slightly in the opposite direction.

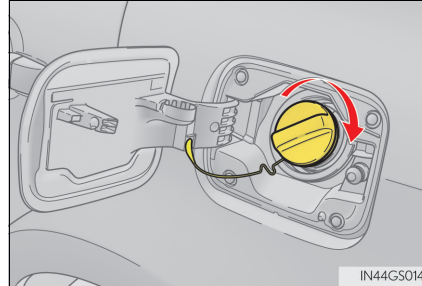

- 2 Close the fuel filler door, and press the center of the rear edge of the fuel filler door until you hear a click. When you lock the doors, the fuel filler door will lock also.

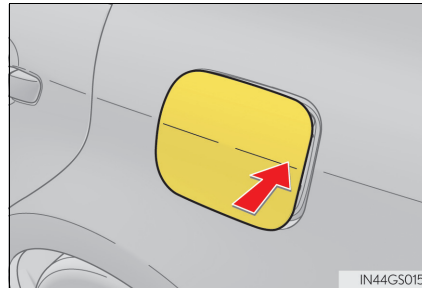

Fuel filler door lock condition

The fuel filler door may not be locked even when the vehicle's doors are locked in the following conditions:

- When operating the door lock button inside the vehicle
- When the automatic door locking system is operated (→P. 143)
- When the fuel filler door is closed after the vehicle's doors are locked

⚠ WARNING

■ When replacing the fuel tank cap

Do not use anything but a genuine Lexus fuel tank cap designed for your vehicle. Doing so may cause a fire or other incident which may result in death or serious injury.

Lexus Safety System+*

The Lexus Safety System+ consists of the following drive assist systems and contributes to a safe and comfortable driving experience:

- ◆ PCS (Pre-Crash Safety system)
→P. 270

- ◆ LKA (Lane-Keeping Assist)
→P. 282

- ◆ AHS (Adaptive High-beam System)*
→P. 241

- ◆ Automatic High Beam*
→P. 246

- ◆ RSA (Road Sign Assist)
→P. 291

- ◆ Dynamic radar cruise control with full-speed range
→P. 296

WARNING

■ Lexus Safety System+

The Lexus Safety System+ is designed to operate under the assumption that the driver will drive safely, and is designed to help reduce the impact to the occupants and the vehicle in the case of a collision or assist the driver in normal driving conditions.

As there is a limit to the degree of recognition accuracy and control performance that this system can provide, do not overly rely on this system. The driver is always responsible for paying attention to the vehicle's surroundings and driving safely.

*: If equipped

Vehicle data recording

The pre-crash safety system is equipped with a sophisticated computer that will record certain data, such as:

- Accelerator status
- Brake status
- Vehicle speed
- Operation status of the pre-crash safety system functions
- Information (such as the distance and relative speed between your vehicle and the vehicle ahead or other objects)

The pre-crash safety system does not record conversations, sounds or pictures.

● Data usage

Lexus may use the data recorded in this computer to diagnose malfunctions, conduct research and development, and improve quality.

Lexus will not disclose the recorded data to a third party except:

- With the consent of the vehicle owner or with the consent of the lessee if the vehicle is leased
- In response to an official request by the police, a court of law or a government agency
- For use by Lexus in a lawsuit
- For research purposes where the data is not tied to a specific vehicle or vehicle owner

Sensors

Two types of sensors, located behind the front grille and windshield, detect information necessary to operate the drive assist systems.

- ① Radar sensor
- ② Camera sensor

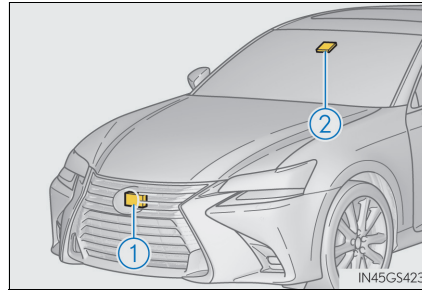

⚠ WARNING

■ **To avoid malfunction of the radar sensor**

Observe the following precautions.

Otherwise, the radar sensor may not operate properly, possibly leading to an accident resulting in death or serious injury.

- Keep the radar sensor and front grille emblem clean at all times.

- ① Radar sensor
- ② Front grille emblem

If the front of the radar sensor or the front or back of the front grille emblem is dirty or covered with water droplets, snow, etc., clean it.

Clean the radar sensor and front grille emblem with a soft cloth so you do not mark or damage them.

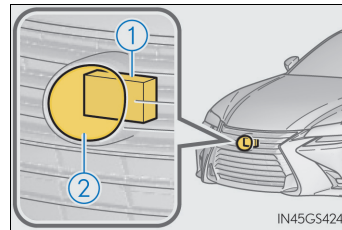

- Do not attach accessories, stickers (including transparent stickers) or other items to the radar sensor, front grille emblem or surrounding area.
- Do not subject the radar sensor or surrounding area to a strong impact. If the radar sensor, front grille, or front bumper has been subjected to a strong impact, have the vehicle inspected by your any authorized Lexus retailer or Lexus authorized repairer, or any reliable repairer.
- Do not disassemble the radar sensor.
- Do not modify or paint the radar sensor, front grille emblem or surrounding area.
- If the radar sensor, front grille, or front bumper needs to be removed and installed, or replaced, contact your any authorized Lexus retailer or Lexus authorized repairer, or any reliable repairer.

⚠ WARNING

■ **To avoid malfunction of the camera sensor**

Observe the following precautions.

Otherwise, the camera sensor may not operate properly, possibly leading to an accident resulting in death or serious injury.

- Keep the windshield clean at all times.
 - If the windshield is dirty or covered with an oily film, water droplets, snow, etc., clear the windshield.
 - If a glass coating agent is applied to the windshield, it will still be necessary to use the windshield wipers to remove water droplets, etc. from the area of the windshield in front of the camera sensor.
 - If the inner side of the windshield where the camera sensor is installed is dirty, contact any authorized Lexus retailer or Lexus authorized repairer, or any reliable repairer.
- Do not install an antenna or attach stickers (including transparent stickers) or other items to the area of the windshield in front of the camera sensor (shaded area in the illustration).

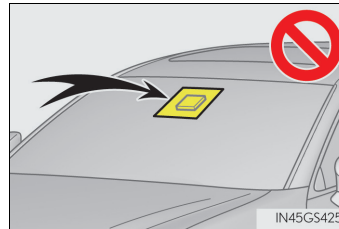

- If the part of the windshield in front of the camera sensor is fogged up or covered with condensation or ice, use the windshield defogger to remove the fog, condensation or ice. (→P. 352)
- If water droplets cannot be properly removed from the area of the windshield in front of the camera sensor by the windshield wipers, replace the wiper insert or wiper blade.
If the wiper inserts or wiper blades need to be replaced, contact any authorized Lexus retailer or Lexus authorized repairer, or any reliable repairer.
- Do not attach window tinting to the windshield.
- Replace the windshield if it is damaged or cracked.
If the windshield needs to be replaced, contact any authorized Lexus retailer or Lexus authorized repairer, or any reliable repairer.
- Do not get the camera sensor wet.
- Do not allow bright lights to shine into the camera sensor.
- Do not dirty or damage the camera sensor.
When cleaning the inside of the windshield, do not allow glass cleaner to contact the lens. Also, do not touch the lens.
If the lens is dirty or damaged, contact any authorized Lexus retailer or Lexus authorized repairer, or any reliable repairer.

**WARNING**

- Do not subject the camera sensor to a strong impact.
- Do not change the installation position or direction of the camera sensor or remove it.
- Do not disassemble the camera sensor.
- Do not install an electronic device or device that emits strong electric waves near the camera sensor.
- Do not modify any components of the vehicle around the camera sensor (inside rear view mirror, etc.) or ceiling.
- Do not attach any accessories that may obstruct the camera sensor to the hood, front grille or front bumper. Contact any authorized Lexus retailer or Lexus authorized repairer, or any reliable repairer for details.
- If a surfboard or other long object is to be mounted on the roof, make sure that it will not obstruct the camera sensor.
- Do not modify the headlights or other lights.

■ Certification

 <p>The latest "DECLARATION of CONFORMITY" (DoC) is available at the following address: http://www.globaldenso.com/en/products/oem/index.html</p>
<p>Hereby, DENSO CORPORATION declares that this DNMWR008 is in compliance with the essential requirements and other relevant provisions of Directive 1999/5/EC.</p>
<p>DENSO CORPORATION vakuuttaa täten että DNMWR008 tyyppinen laite on direktiivin 1999/5/EY oleellisten vaatimusten ja sitä koskevien direktiivin muiden ehtojen mukainen.</p>
<p>Hierbij verklaart DENSO CORPORATION dat het toestel DNMWR008 in overeenstemming is met de essentiële eisen en de andere relevante bepalingen van richtlijn 1999/5/EG.</p>
<p>Par la présente DENSO CORPORATION déclare que l'appareil DNMWR008 est conforme aux exigences essentielles et aux autres dispositions pertinentes de la directive 1999/5/CE.</p>
<p>Härmed intygar DENSO CORPORATION att denna DNMWR008 står i överensstämmelse med de väsentliga egenskapskrav och övriga relevanta bestämmelser som framgår av direktiv 1999/5/EG.</p>
<p>Undertegnede DENSO CORPORATION erklærer herved, at følgende udstyr DNMWR008 overholder de væsentlige krav og øvrige relevante krav i direktiv 1999/5/EF.</p>
<p>Hiermit erklärt DENSO CORPORATION, dass sich das Gerät DNMWR008 in Übereinstimmung mit den grundlegenden Anforderungen und den übrigen einschlägigen Bestimmungen der Richtlinie 1999/5/EG befindet.</p>
<p>ΜΕ ΤΗΝ ΠΑΡΟΥΣΑ DENSO CORPORATION ΔΗΛΩΝΕΙ ΟΤΙ DNMWR008 ΣΥΜΜΟΡΦΩΝΕΤΑΙ ΠΡΟΣ ΤΙΣ ΟΥΣΙΩΔΕΙΣ ΑΠΑΙΤΗΣΕΙΣ ΚΑΙ ΤΙΣ ΛΟΙΠΕΣ ΣΧΕΤΙΚΕΣ ΔΙΑΤΑΞΕΙΣ ΤΗΣ ΟΔΗΓΙΑΣ 1999/5/ΕΚ.</p>

<p>Con la presente DENSO CORPORATION dichiara che questo DNMWR008 è conforme ai requisiti essenziali ed alle altre disposizioni pertinenti stabilite dalla direttiva 1999/5/CE.</p>
<p>Por medio de la presente DENSO CORPORATION declara que el DNMWR008 cumple con los requisitos esenciales y cualesquiera otras disposiciones aplicables o exigibles de la Directiva 1999/5/CE.</p>
<p>DENSO CORPORATION declara que este DNMWR008 está conforme com os requisitos essenciais e outras disposições da Directiva 1999/5/CE.</p>
<p>Hawnhekk, DENSO CORPORATION, jiddikjara li dan DNMWR008 jikkonforma mal-ftiġġijiet essenzjali u ma provvedimenti oħrajn relevanti li hemm fid-Dirrettiva 1999/5/EC.</p>
<p>Käesolevaga kinnitab DENSO CORPORATION seadme DNMWR008 vastavust direktiivi 1999/5/EÜ põhinõuetele ja nimetatud direktiivist tulenevatele teistele asjakohastele sätetele.</p>
<p>Alulírott, DENSO CORPORATION nyilatkozom, hogy a DNMWR008 megfelel a vonatkozó alapvető követelményeknek és az 1999/5/EC irányelv egyéb előírásainak.</p>
<p>DENSO CORPORATION tímto vyhlasuje, že DNMWR008 splňa základné požiadavky a všetky príslušné ustanovenia Smernice 1999/5/ES.</p>
<p>DENSO CORPORATION tímto prohlašuje, že tento DNMWR008 je ve shodě se základními požadavky a dalšími příslušnými ustanoveními směrnice 1999/5/ES.</p>
<p>DENSO CORPORATION izjavlja, da je ta DNMWR008 v skladu z bistvenimi zahtevami in ostalimi relevantnimi določili direktive 1999/5/ES.</p>

Šiuo DENSO CORPORATION deklaruoja, kad šis DNMWR008 atitinka esminius reikalavimus ir kitas 1999/5/EB Direktyvos nuostatas.
Ar šo DENSO CORPORATION deklarē, ka DNMWR008 atbilst Direktīvas 1999/5/EK būtiskajām prasībām un citiem ar to saistītajiem noteikumiem.
Niniejszym DENSO CORPORATION oświadcza, że DNMWR008 jest zgodny z zasadniczymi wymogami oraz pozostałymi stosownymi postanowieniami Dyrektywy 1999/5/EC.
DENSO CORPORATION erklærer herved at udstyret DNMWR008 er i samsvar med de grunnleggende krav og øvrige relevante krav i direktiv 1999/5/EF.
С настоящето, DENSO CORPORATION, декларира, че DNMWR008 е в съответствие със съществените изисквания и другите приложими разпоредби на Директива 1999/5/ЕС.
Prin prezenta, DENSO CORPORATION, declară că aparatul DNMWR008 este în conformitate cu cerințele esențiale și cu alte prevederi pertinente ale Directivei 1999/5/CE.
Ovim DENSO CORPORATION, izjavljuje da je DNMWR008 u skladu s bitnim zahtjevima i drugim relevantnim odredbama Direktive 1999/5/EC i Pravilnika o RiTT opremi (NN 25/2012).

PCS (Pre-Crash Safety system)*

The pre-crash safety system uses a radar sensor and camera sensor to detect vehicles and pedestrians*¹ in front of your vehicle. When the system determines that the possibility of a frontal collision with a vehicle or pedestrian is high, a warning operates to urge the driver to take evasive action and the potential brake pressure is increased to help the driver avoid the collision. If the system determines that the possibility of a frontal collision with a vehicle or pedestrian is extremely high, the brakes are automatically applied*² to help avoid the collision or help reduce the impact of the collision.

The pre-crash safety system can be disabled/enabled and the warning timing can be changed. (→P. 273)

*¹: Depending on the region in which the vehicle was sold, the pedestrian detection function may not be available. Contact any authorized Lexus retailer or Lexus authorized repairer, or any reliable repairer for details.

*²: Depending on the region in which the vehicle was sold, the pre-crash braking function (automatic braking function) may not be available. Contact any authorized Lexus retailer or Lexus authorized repairer, or any reliable repairer for details.

◆ Pre-crash warning

When the system determines that the possibility of a frontal collision is high, a buzzer will sound and a warning message will be displayed on the multi-information display to urge the driver to take evasive action.

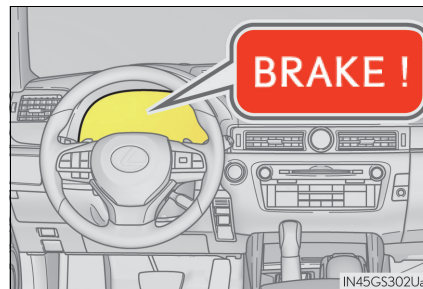

◆ Pre-crash brake assist

When the system determines that the possibility of a frontal collision is high, the system applies greater braking force in relation to how strongly the brake pedal is depressed.

*: If equipped

◆ Pre-crash braking*³

When the system determines that the possibility of a frontal collision is high, the system warns the driver. If the system determines that the possibility of a frontal collision is extremely high, the brakes are automatically applied to help avoid the collision or reduce the collision speed.

*³: Depending on the region in which the vehicle was sold, the pre-crash braking function may not be available.

◆ Suspension control (if equipped)

When the system determines that the possibility of a frontal collision is high, the Adaptive Variable Suspension System (→P. 325) will control the damping force of the shock absorbers to help maintain an appropriate vehicle posture.

◆ Steering control (if equipped)

When the system determines that the possibility of a frontal collision is high and the driver is operating the steering wheel, the LDH system (→P. 325) will control the turning angle of the front and rear wheels and effort necessary to turn the steering wheel to help enhance steering responsiveness.

WARNING

■ Limitations of the pre-crash safety system

- The driver is solely responsible for safe driving. Always drive safely, taking care to observe your surroundings.
Do not use the pre-crash safety system instead of normal braking operations under any circumstances. This system will not prevent collisions or lessen collision damage or injury in every situation. Do not overly rely on this system. Failure to do so may lead to an accident, resulting in death or serious injury.
- Although this system is designed to help avoid a collision or help reduce the impact of the collision, its effectiveness may change according to various conditions, therefore the system may not always be able to achieve the same level of performance. Read the following conditions carefully. Do not overly rely on this system and always drive carefully.
 - Conditions under which the system may operate even if there is no possibility of a collision: →P. 276
 - Conditions under which the system may not operate properly: →P. 279
- Do not attempt to test the operation of the pre-crash safety system yourself, as the system may not operate properly, possibly leading to an accident.

⚠ WARNING**■ Pre-crash braking ^{*3}**

- When the pre-crash braking function is operating, a large amount of braking force will be applied.
- If the vehicle is stopped by the operation of the pre-crash braking function, the pre-crash braking function operation will be canceled after approximately 2 seconds. Depress the brake pedal as necessary.
- The pre-crash braking function may not operate if certain operations are performed by the driver. If the accelerator pedal is being depressed strongly or the steering wheel is being turned, the system may determine that the driver is taking evasive action and possibly prevent the pre-crash braking function from operating.
- In some situations, while the pre-crash braking function is operating, operation of the function may be canceled if the accelerator pedal is depressed strongly or the steering wheel is turned and the system determines that the driver is taking evasive action.
- If the brake pedal is being depressed, the system may determine that the driver is taking evasive action and possibly delay the operation timing of the pre-crash braking function.

^{*3}: Depending on the region in which the vehicle was sold, the pre-crash braking function may not be available.

■ When to disable the pre-crash safety system

In the following situations, disable the system, as it may not operate properly, possibly leading to an accident resulting in death or serious injury:

- When the vehicle is being towed
- When your vehicle is towing another vehicle
- When transporting the vehicle via truck, boat, train or similar means of transportation
- When the vehicle is raised on a lift with the hybrid system on and the tires are allowed to rotate freely
- When inspecting the vehicle using a drum tester such as a chassis dynamometer or speedometer tester, or when using an on vehicle wheel balancer
- When a strong impact is applied to the front bumper or front grille, due to an accident or other reasons
- If the vehicle cannot be driven in a stable manner, such as when the vehicle has been in an accident or is malfunctioning
- When the vehicle is driven in a sporty manner or off-road
- When the tires are not properly inflated
- When the tires are very worn
- When tires of a size other than specified are installed
- When tire chains are installed
- When a compact spare tire or an emergency tire puncture repair kit is used
- If equipment (snow plow, etc.) that may obstruct the radar sensor or camera sensor is temporarily installed to the vehicle

Changing settings of the pre-crash safety system

■ Enabling/disabling the pre-crash safety system

The pre-crash safety system can be enabled/disabled on  (→P. 111) of the multi-information display.

The system is automatically enabled each time the power switch is turned to ON mode.

If the system is disabled, the PCS warning light will turn on and a message will be displayed on the multi-information display.

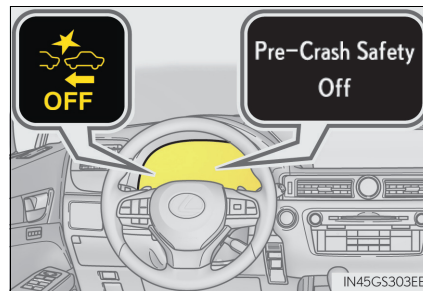

■ Changing the pre-crash warning timing

The pre-crash warning timing can be changed on  (→P. 111) of the multi-information display.

The operation timing setting is retained when the power switch is turned off.

- ① Far
The warning will begin to operate earlier than with the default timing.
- ② Middle
This is the default setting.
- ③ Near
The warning will begin to operate later than with the default timing.

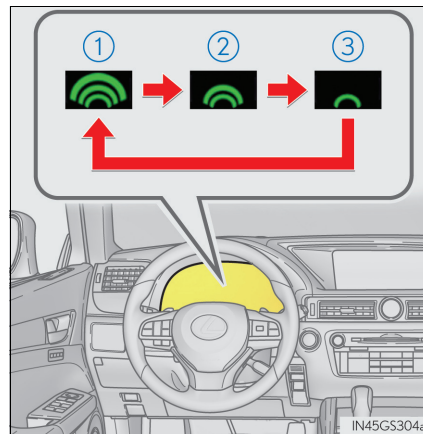

■ **Operational conditions**

Availability of the pedestrian detection function and pre-crash braking function depend on the region in which the vehicle was sold.

Regions	Function availability
Region A	The pedestrian detection function and pre-crash braking function are available
Region B	The pedestrian detection function is not available and the pre-crash braking function is available
Region C	The pedestrian detection function and pre-crash braking function are not available

Read the following for details:

► Region A

(The pedestrian detection function and pre-crash braking function are available)

The pre-crash safety system is enabled and the system determines that the possibility of a frontal collision with a vehicle or pedestrian is high.

Each function is operational at the following speeds:

- Pre-crash warning:
 - Vehicle speed is between approximately 10 and 180 km/h (7 and 110 mph). (For detecting a pedestrian, vehicle speed is between approximately 10 and 80 km/h [7 and 50 mph].)
 - The relative speed between your vehicle and the vehicle or pedestrian ahead is approximately 10 km/h (7 mph) or more.
- Pre-crash brake assist:
 - Vehicle speed is between approximately 30 and 180 km/h (19 and 110 mph). (For detecting a pedestrian, vehicle speed is between approximately 30 and 80 km/h [19 and 50 mph].)
 - The relative speed between your vehicle and the vehicle or pedestrian ahead is approximately 30 km/h (19 mph) or more.
- Pre-crash braking:
 - Vehicle speed is between approximately 10 and 180 km/h (7 and 110 mph). (For detecting a pedestrian, vehicle speed is between approximately 10 and 80 km/h [7 and 50 mph].)
 - The relative speed between your vehicle and the vehicle or pedestrian ahead is approximately 10 km/h (7 mph) or more.

The system may not operate in the following situations:

- If a 12-volt battery terminal has been disconnected and reconnected and then the vehicle has not been driven for a certain amount of time
- If the shift lever is in R
- If VSC is disabled (only the pre-crash warning function will be operational)
- If the PCS warning light is flashing or illuminated

- ▶ Region B
(The pedestrian detection function is not available and the pre-crash braking function is available)

The pre-crash safety system is enabled and the system determines that the possibility of a frontal collision with a vehicle is high.

Each function is operational at the following speeds:

- Pre-crash warning:
 - Vehicle speed is between approximately 15 and 180 km/h (10 and 110 mph).
 - The relative speed between your vehicle and the vehicle ahead is approximately 10 km/h (7 mph) or more.
- Pre-crash brake assist:
 - Vehicle speed is between approximately 30 and 180 km/h (19 and 110 mph).
 - The relative speed between your vehicle and the vehicle ahead is approximately 30 km/h (19 mph) or more.
- Pre-crash braking:
 - Vehicle speed is between approximately 15 and 180 km/h (10 and 110 mph).
 - The relative speed between your vehicle and the vehicle ahead is approximately 10 km/h (7 mph) or more.

The system may not operate in the following situations:

- If a 12-volt battery terminal has been disconnected and reconnected and then the vehicle has not been driven for a certain amount of time
- If the shift lever is in R
- If VSC is disabled (only the pre-crash warning function will be operational)
- If the PCS warning light is flashing or illuminated

- ▶ Region C
(The pedestrian detection function and pre-crash braking function are not available)

The pre-crash safety system is enabled and the system determines that the possibility of a frontal collision with a vehicle is high.

Each function is operational at the following speeds:

- Pre-crash warning:
 - Vehicle speed is between approximately 15 and 180 km/h (10 and 110 mph).
 - The relative speed between your vehicle and the vehicle ahead is approximately 10 km/h (7 mph) or more.
- Pre-crash brake assist:
 - Vehicle speed is between approximately 30 and 180 km/h (19 and 110 mph).
 - The relative speed between your vehicle and the vehicle ahead is approximately 30 km/h (19 mph) or more.

The system may not operate in the following situations:

- If a battery terminal has been disconnected and reconnected and then the vehicle has not been driven for a certain amount of time
- If the shift lever is in R
- If VSC is disabled (only the pre-crash warning function will be operational)
- If the PCS warning light is flashing or illuminated

■ Pedestrian detection function *4

The pre-crash safety system detects pedestrians based on the size, profile, and motion of a detected object. However, a pedestrian may not be detected depending on the surrounding brightness and the motion, posture, and angle of the detected object, preventing the system from operating properly. (→P. 280)

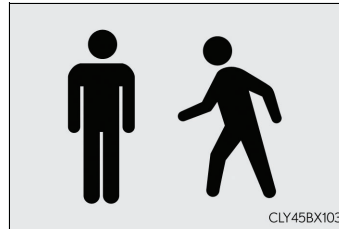

*4: Depending on the region in which the vehicle was sold, the pedestrian detection function may not be available.

■ Cancellation of the pre-crash braking *3

If either of the following occur while the pre-crash braking function is operating, it will be canceled:

- The accelerator pedal is depressed strongly.
- The steering wheel is turned sharply or abruptly.

*3: Depending on the region in which the vehicle was sold, the pre-crash braking function may not be available.

■ Conditions under which the system may operate even if there is no possibility of a collision

● In some situations such as the following, the system may determine that there is a possibility of a frontal collision and operate.

- When passing a vehicle or pedestrian *4
- When changing lanes while overtaking a preceding vehicle
- When overtaking a preceding vehicle that is changing lanes
- When overtaking a preceding vehicle that is making a left/right turn

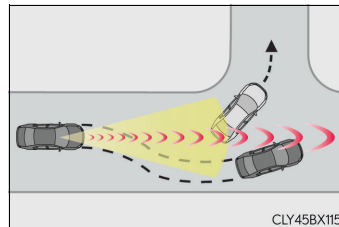

- When passing a vehicle in an oncoming lane that is stopped to make a right/left turn

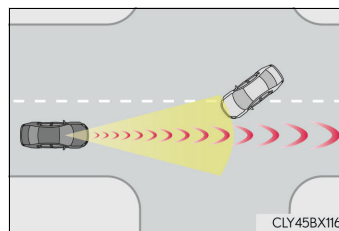

- When driving on a road where relative location to vehicle ahead in an adjacent lane may change, such as on a winding road

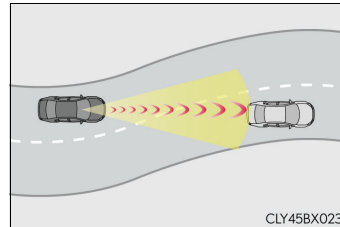

- When rapidly closing on a vehicle ahead
- If the front of the vehicle is raised or lowered, such as when the road surface is uneven or undulating
- When approaching objects on the roadside, such as guardrails, utility poles, trees, or walls
- When there is a vehicle, pedestrian^{*4}, or object by the roadside at the entrance of a curve

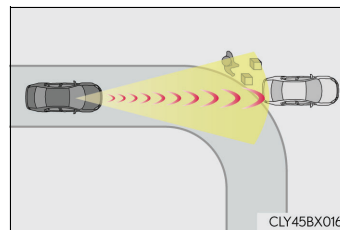

- When driving on a narrow path surrounded by a structure, such as in a tunnel or on an iron bridge
- When there is a metal object (manhole cover, steel plate, etc.), steps, or a protrusion on the road surface or roadside
- When a crossing pedestrian approaches very close to the vehicle^{*4}

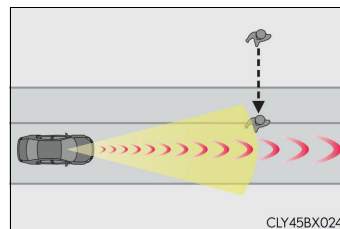

- When passing through a place with a low structure above the road (low ceiling, traffic sign, etc.)

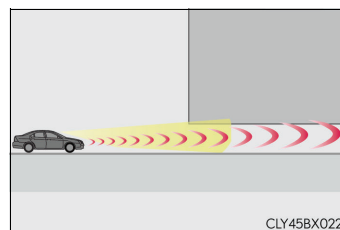

278 4-5. Using the driving support systems

- When passing under an object (billboard, etc.) at the top of an uphill road

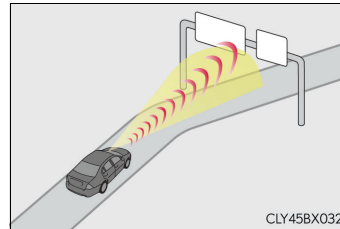

- When rapidly closing on an electric toll gate barrier, parking area barrier, or other barrier that opens and closes
- When using an automatic car wash
- When driving through or under objects that may contact the vehicle, such as thick grass, tree branches, or a banner

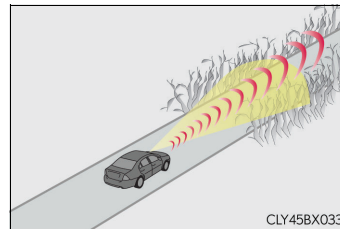

- When the vehicle is hit by water, snow, dust, etc. from a vehicle ahead
- When driving through steam or smoke
- When there are patterns or paint on the road or a wall that may be mistaken for a vehicle or pedestrian ^{*4}
- When driving near an object that reflects radio waves, such as a large truck or guardrail
- When driving near a TV tower, broadcasting station, electric power plant, or other location where strong radio waves or electrical noise may be present

^{*4}: Depending on the region in which the vehicle was sold, the pedestrian detection function may not be available.

■ Situations in which the system may not operate properly

- In some situations such as the following, a vehicle may not be detected by the radar sensor and camera sensor, preventing the system from operating properly:

- If an oncoming vehicle is approaching your vehicle
- If a vehicle ahead is a motorcycle or bicycle
- When approaching the side or front of a vehicle
- If a preceding vehicle has a small rear end, such as an unloaded truck
- If a preceding vehicle has a low rear end, such as a low bed trailer

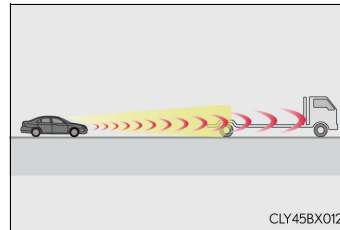

- If a vehicle ahead is carrying a load which protrudes past its rear bumper
- If a vehicle ahead has extremely high ground clearance

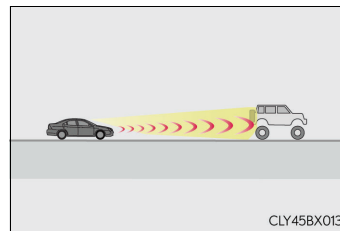

- If a vehicle ahead is irregularly shaped, such as a tractor or side car
- If the sun or other light is shining directly on a vehicle ahead
- If a vehicle cuts in front of your vehicle or emerges from beside a vehicle
- If a vehicle ahead makes an abrupt maneuver (such as sudden swerving, acceleration or deceleration)
- When suddenly cutting behind a preceding vehicle
- When a vehicle ahead is not directly in front of your vehicle

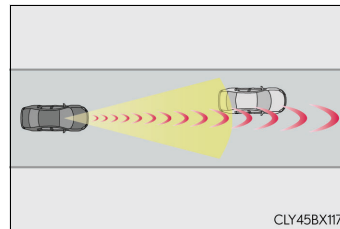

- When driving in inclement weather such as heavy rain, fog, snow or a sandstorm
- When the vehicle is hit by water, snow, dust, etc. from a vehicle ahead
- When driving through steam or smoke
- When driving in a place where the surrounding brightness changes suddenly, such as at the entrance or exit of a tunnel
- When a very bright light, such as the sun or the headlights of oncoming traffic, shines directly into the camera sensor
- When the surrounding area is dim, such as at dawn or dusk, or while at night or in a tunnel

280 4-5. Using the driving support systems

- After the hybrid system has started the vehicle has not been driven for a certain amount of time
- While making a left/right turn and for a few seconds after making a left/right turn
- While driving on a curve and for a few seconds after driving on a curve
- If your vehicle is skidding
- If the front of the vehicle is raised or lowered

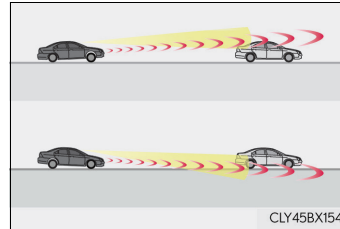

- If the wheels are misaligned
- If a wiper blade is blocking the camera sensor
- The vehicle is wobbling.
- The vehicle is being driven at extremely high speeds.
- When driving on a hill
- If the radar sensor or camera sensor is misaligned
- In some situations such as the following, sufficient braking force may not be obtained, preventing the system from performing properly:
 - If the braking functions cannot operate to their full extent, such as when the brake parts are extremely cold, extremely hot, or wet
 - If the vehicle is not properly maintained (brakes or tires are excessively worn, improper tire inflation pressure, etc.)
 - When the vehicle is being driven on a gravel road or other slippery surface
- Some pedestrians such as the following may not be detected by the radar sensor and camera sensor, preventing the system from operating properly ^{*4}:
 - Pedestrians shorter than approximately 1 m (3.2 ft.) or taller than approximately 2 m (6.5 ft.)
 - Pedestrians wearing oversized clothing (a rain coat, long skirt, etc.), making their silhouette obscure
 - Pedestrians who are carrying large baggage, holding an umbrella, etc., hiding part of their body
 - Pedestrians who are bending forward or squatting
 - Pedestrians who are pushing a stroller, wheelchair, bicycle or other vehicle
 - Groups of pedestrians which are close together
 - Pedestrians who are wearing white and look extremely bright
 - Pedestrians in the dark, such as at night or while in a tunnel
 - Pedestrians whose clothing appears to be nearly the same color or brightness as their surroundings
 - Pedestrians near walls, fences, guardrails, or large objects
 - Pedestrians who are on a metal object (manhole cover, steel plate, etc.) on the road
 - Pedestrians who are walking fast
 - Pedestrians who are changing speed abruptly
 - Pedestrians running out from behind a vehicle or a large object
 - Pedestrians who are extremely close to the side of the vehicle (outside rear view mirror, etc.)

*4: Depending on the region in which the vehicle was sold, the pedestrian detection function may not be available.

■ **If the PCS warning light flashes and a warning message is displayed on the multi-information display**

The pre-crash safety system may be temporarily unavailable or there may be a malfunction in the system.

- In the following situations, the warning light will turn off, the message will disappear and the system will become operational when normal operating conditions return:
 - When the radar sensor or camera sensor or the area around either sensor is hot, such as in the sun
 - When the radar sensor or camera sensor or the area around either sensor is cold, such as in an extremely cold environment
 - When the radar sensor or front grille emblem is dirty or covered with snow, etc.
 - When the part of the windshield in front of the camera sensor is fogged up or covered with condensation or ice (Defogging the windshield: →P. 352)
 - If the camera sensor is obstructed, such as when the hood is open or a sticker is attached to the windshield near the camera sensor
- If the PCS warning light continues to flash or the warning message does not disappear, the system may be malfunctioning. Have the vehicle inspected by any authorized Lexus retailer or Lexus authorized repairer, or any reliable repairer immediately.

■ **If VSC is disabled**

- If VSC is disabled (→P. 327), the pre-crash brake assist and pre-crash braking functions are also disabled.
- The PCS warning light will turn on and “VSC Turned Off Pre-Crash Brake System Unavailable” will be displayed on the multi-information display.

LKA (Lane-Keeping Assist)*

Summary of functions

When driving on highways and freeways with white or yellow lines, this function alerts the driver when the vehicle might depart from its lane and provides assistance by operating the steering wheel to keep the vehicle in its lane. Furthermore, the system also provides steering assistance when dynamic radar cruise control with full-speed range is operating to keep the vehicle in its lane.

The LKA system recognizes visible white or yellow lines with the camera sensor on the upper portion of the front windshield.

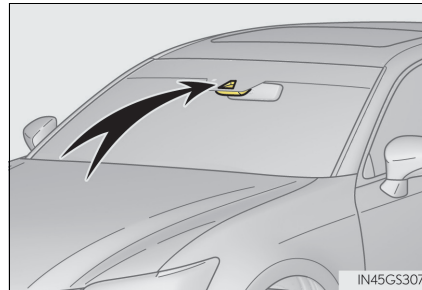

Functions included in LKA system

◆ Lane departure alert function

When the system determines that the vehicle might depart from its lane, a warning is displayed on the multi-information display, and either the warning buzzer sounds or the steering wheel vibrates to alert the driver.

When the warning buzzer sounds or the steering wheel vibrates, check the surrounding road situation and carefully operate the steering wheel to move the vehicle back to the center of the lane.

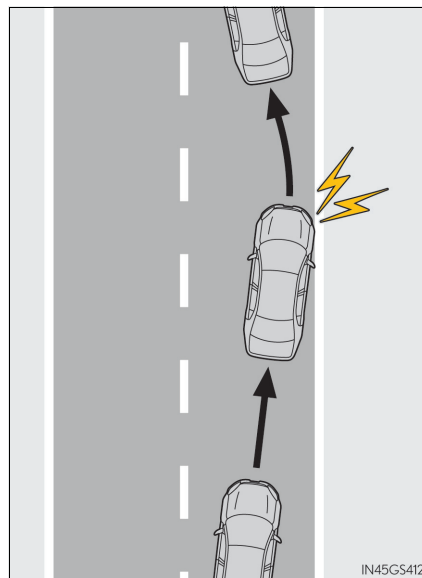

*: If equipped

◆ Steering assist function

When the system determines that the vehicle might depart from its lane, the system provides assistance as necessary by operating the steering wheel in small amounts for a short period of time to keep the vehicle in its lane.

For Israel: If the system detects that the steering wheel has not been operated for a fixed amount of time or the steering wheel is not being firmly gripped, a warning is displayed on the multi-information display and the warning buzzer sounds.

Except for Israel: If the system detects that the steering wheel has not been operated for a fixed amount of time or the steering wheel is not being firmly gripped, a warning is displayed on the multi-information display and the function is temporarily canceled.

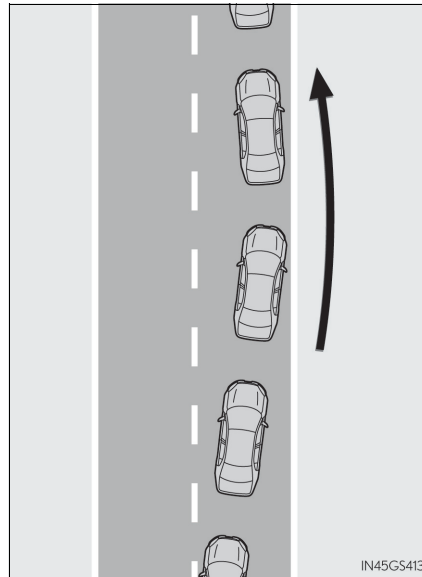

4

Driving

◆ Vehicle sway warning function

When the vehicle is swaying or appears as if it may depart from its lane multiple times, the warning buzzer sounds and a message is displayed on the multi-information display to alert the driver.

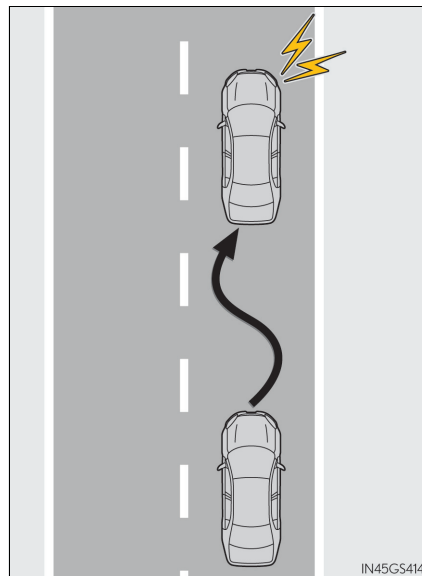

◆ Lane centering function

This function is linked with radar cruise control and provides the required assistance by operating the steering wheel to keep the vehicle in its current lane.

When radar cruise control is not operating, the lane centering function does not operate.

For Israel: If the system detects that the steering wheel has not been operated for a fixed amount of time or the steering wheel is not being firmly gripped, a warning is displayed on the multi-information display and the warning buzzer sounds.

Except for Israel: If the system detects that the steering wheel has not been operated for a fixed amount of time or the steering wheel is not being firmly gripped, a warning is displayed on the multi-information display and the function is temporarily canceled.

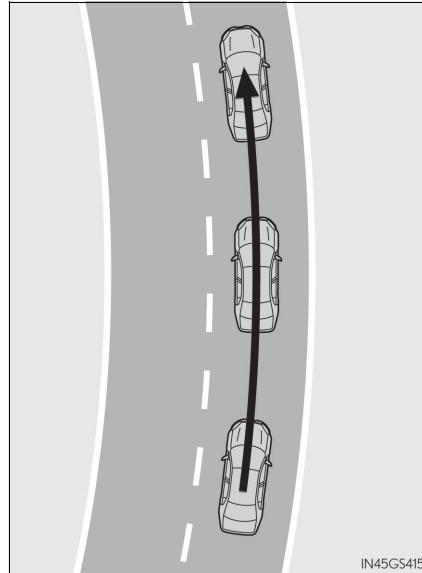

⚠ WARNING**■ Before using LKA system**

Do not rely solely upon the LKA system. The LKA system does not automatically drive the vehicle or reduce the amount of attention that must be paid to the area in front of the vehicle. The driver must always assume full responsibility for driving safely by paying careful attention to the surrounding conditions and operating the steering wheel to correct the path of the vehicle. Also, the driver must take adequate breaks when fatigued, such as from driving for a long period of time.

Failure to perform appropriate driving operations and pay careful attention may lead to an accident, resulting in death or serious injury.

■ To avoid operating LKA system by mistake

When not using the LKA system, use the LKA switch to turn the system off.

■ Situations unsuitable for LKA system

Do not use the LKA system in the following situations.

The system may not operate properly and lead to an accident, resulting in death or serious injury.

- A spare tire, tire chains, etc. are equipped.
- When the tires have been excessively worn, or when the tire inflation pressure is low.
- Tires which differ by structure, manufacturer, brand or tread pattern are used.
- Objects or patterns that could be mistaken for white (yellow) lines are present on the side of the road (guardrails, curbs, reflective poles, etc.).
- Vehicle is driven on a snow-covered road.
- White (yellow) lines are difficult to see due to rain, snow, fog, dust, etc.
- Asphalt repair marks, white (yellow) line marks, etc. are present due to road repair.
- Vehicle is driven in a temporary lane or restricted lane due to construction work.
- Vehicle is driven on a road surface which is slippery due to rainy weather, fallen snow, freezing, etc.
- Vehicle is driven in traffic lanes other than on highways and freeways.
- Vehicle is driven in a construction zone.
- Vehicle is towing a trailer or another vehicle. (vehicles with towing package)

■ Preventing LKA system malfunctions and operations performed by mistake

- Do not modify the headlights or place stickers, etc. on the surface of the lights.
- Do not modify the suspension etc. If the suspension etc. needs to be replaced, contact any authorized Lexus retailer or Lexus authorized repairer, or any reliable repairer.
- Do not install or place anything on the hood or grille. Also, do not install a grille guard (bull bars, kangaroo bar, etc.).
- If your windshield needs repairs, contact any authorized Lexus retailer or Lexus authorized repairer, or any reliable repairer.

Turning LKA system on

Press the LKA switch to turn the LKA system on.

The LKA indicator illuminates and a message is displayed on the multi-information display.

Press the LKA switch again to turn the LKA system off.

When the LKA system is turned on or off, operation of the LKA system continues in the same condition the next time the hybrid system is started.



Indications on multi-information display

① LKA indicator

The illumination condition of the indicator informs the driver of the system operation status.

Illuminated in white:
LKA system is operating.

Illuminated in green:
Steering wheel assistance of the steering assist function or lane centering function is operating.

Flashing in orange:
Lane departure alert function is operating.

② Operation display of steering wheel operation support

Indicates that steering wheel assistance of the steering assist function or lane centering function is operating.

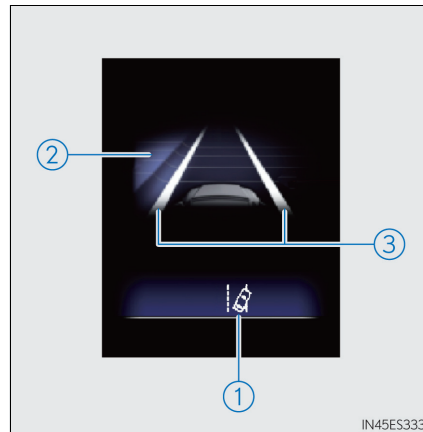

③ Lane departure alert function display

Displayed when the multi-information display is switched to the driving assist system information screen.

- ▶ Inside of displayed white lines is white
- ▶ Inside of displayed white lines is black

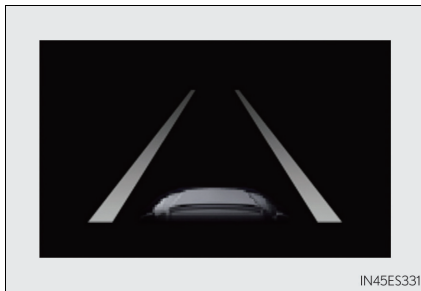

Indicates that the system is recognizing white (yellow) lines. When the vehicle departs from its lane, the white line displayed on the side the vehicle departs from flashes orange.

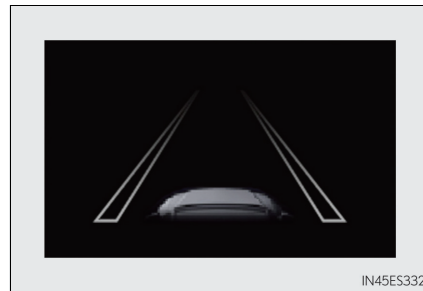

Indicates that the system is not able to recognize white (yellow) lines or is temporarily canceled.

4

Driving

■ Operation conditions of each function

● Lane departure alert function

This function operates when all of the following conditions are met.

- LKA is turned on.
- Vehicle speed is approximately 50 km/h (32 mph) or more.
- System recognizes white (yellow) lines.
- Width of traffic lane is approximately 3 m (9.8 ft.) or more.
- Turn signal lever is not operated.
- Vehicle is driven on a straight road or around a gentle curve with a radius of more than approximately 150 m (492 ft.).
- No system malfunctions are detected. (→P. 290)

● Steering assist function

This function operates when all of the following conditions are met in addition to the operation conditions for the lane departure alert function.

- Setting for "Steering Assist" in  of the multi-information display is set to "On". (→P. 111)
- Vehicle is not accelerated or decelerated by a fixed amount or more.
- Steering wheel is not operated with a steering force level suitable for changing lanes.
- ABS, VSC, TRC and PCS (Pre-Crash Safety system) are not operating.
- TRC or VSC is not turned off.
- Except for Israel: Hands off steering wheel alert is not displayed. (→P. 289)

- Vehicle sway warning

This function operates when all of the following conditions are met.

- Setting for "Sway Warning" in  of the multi-information display is set to "On". (→P. 111)
- Vehicle speed is approximately 50 km/h (32 mph) or more.
- Width of traffic lane is approximately 3 m (9.8 ft.) or more.
- No system malfunctions are detected. (→P. 290)

- Lane centering function

This function operates when all of the following conditions are met.

- LKA is turned on.
- Setting for "Steering Assist" and "Lane Center" in  of the multi-information display are set to "On". (→P. 111)
- System recognizes white (yellow) lines.
- Dynamic radar cruise control with full-speed range is operating.
- Width of traffic lane is approximately 2.5 to 4.1 m (8.2 to 13.5 ft.).
- Turn signal lever is not operated.
- Vehicle is driven on a straight road or around a gentle curve with a radius of more than approximately 200 m (656 ft.).
- No system malfunctions are detected. (→P. 290)
- Vehicle does not accelerate or decelerate by a fixed amount or more.
- Steering wheel is not operated with a steering force level suitable for changing lanes.
- ABS, VSC, TRC and PCS (Pre-Crash Safety system) are not operating.
- TRC or VSC is not turned off.
- Except for Israel: Hands off steering wheel alert is not displayed. (→P. 289)
- Steering assist function is not operating.

- Temporary cancellation of functions

When operation conditions are no longer met, a function may be temporarily canceled. However, when the operation conditions are met again, operation of the function is automatically restored. (→P. 287)

- Steering assist function/lane centering function

Depending on the vehicle speed, lane departure situation, road conditions, etc., the driver may not feel the function is operating or the function may not operate at all.

- Lane departure alert function

The warning buzzer may be difficult to hear due to external noise, audio playback, etc. Also, it may be difficult to feel steering wheel vibrations due to the road conditions, etc.

■ Hands off steering wheel alert

For Israel: When the system determines that the driver has removed the hands from the steering wheel while the steering assist function or lane centering function is operating, a warning message is displayed on the multi-information display and the buzzer sounds.

Except for Israel: When the system determines that the driver has removed the hands from the steering wheel while the steering assist function or lane centering function is operating, a warning message is displayed on the multi-information display.

If the driver continues to keep the hands off of the steering wheel, the buzzer sounds, a warning message is displayed and the function is temporarily canceled. This alert also operates in the same way when the vehicle is driven with the steering wheel lightly gripped. However, depending on the road conditions, etc., the function may not cancel.

■ White (yellow) lines are only on one side of road

The LKA system will not operate for the side on which white (yellow) lines could not be recognized.

■ Conditions in which functions may not operate properly

In the following situations, the camera sensor may not detect white (yellow) lines and various functions may not operate normally.

- There are shadows on the road that run parallel with, or cover, the white (yellow) lines.
- The vehicle is driven in an area without white (yellow) lines, such as in front of a tollgate or checkpoint, or at an intersection, etc.
- The white (yellow) lines are cracked, "Raised pavement marker" or stones are present.
- The white (yellow) lines cannot be seen or are difficult to see due to sand, etc.
- The vehicle is driven on a road surface that is wet due to rain, puddles, etc.
- The traffic lines are yellow (which may be more difficult to recognize than lines that are white).
- The white (yellow) lines cross over a curb, etc.
- The vehicle is driven on a bright surface, such as concrete.
- The vehicle is driven on a surface that is bright due to reflected light, etc.
- The vehicle is driven in an area where the brightness changes suddenly, such as at the entrances and exits of tunnels, etc.
- Light from the headlights of an oncoming vehicle, the sun, etc. enters the camera.
- The vehicle is driven where the road diverges, merges, etc.
- The vehicle is driven on a slope.

- The vehicle is driven on a road which tilts left or right, or a winding road.
- The vehicle is driven on an unpaved or rough road.
- The vehicle is driven around a sharp curve.
- The traffic lane is excessively narrow or wide.
- The vehicle is extremely tilted due to carrying heavy luggage or having improper tire pressure.
- The distance to the preceding vehicle is extremely short.
- The vehicle is moving up and down a large amount due to road conditions during driving (poor roads or road seams).
- The headlight lenses are dirty and emit a faint amount of light at night, or the beam axis has deviated.
- The vehicle is struck by a crosswind.
- The vehicle has just changed lanes or crossed an intersection.
- Snow tires, etc. are equipped.

■ **Warning message**

Warning messages are used to indicate a system malfunction or to inform the driver of the need for caution while driving. (→P. 466)

■ **Customization**

The following settings can be changed.

Function	Setting details
Lane departure alert function	Adjust alert sensitivity
	Adjust alert type
Steering assist function	Turn steering wheel assistance on and off
Vehicle sway warning function	Turn function on and off
	Adjust alert sensitivity
Lane centering function	Turn function on and off

For how to change settings, refer to P. 561.

RSA (Road Sign Assist)*

Summary of function

RSA recognizes specific road signs using the camera sensor and provides information to the driver via the multi-information display.

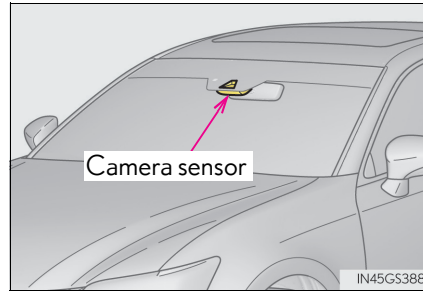

If the system judges that the vehicle is being driven over the speed limit, performing prohibited actions, etc. in relation to the recognized road signs, it alerts the driver using a warning display and warning buzzer*.

*: This setting needs to be customized.

WARNING

■ Before using the RSA

Do not rely solely upon the RSA system. RSA is a system which supports the driver by providing information, but it is not a replacement for a driver's own vision and awareness. Drive safely by always paying careful attention to the traffic rules. Inappropriate or negligent driving could lead to an unexpected accident.

*: If equipped

Indication on the multi-information display

After the camera sensor recognizes a sign, it is displayed on the multi-information display when the vehicle passes the sign.

- When the driving assist system information is selected, a maximum of 3 signs can be displayed. (→P. 111)

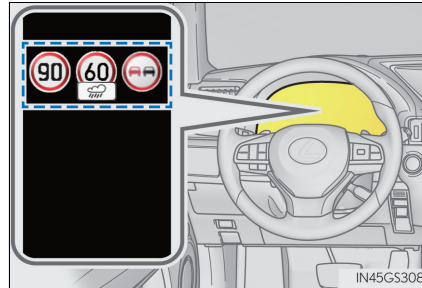

- When other than the driving assist system information is selected, a speed limit sign or an all canceled sign can be displayed. (→P. 111)



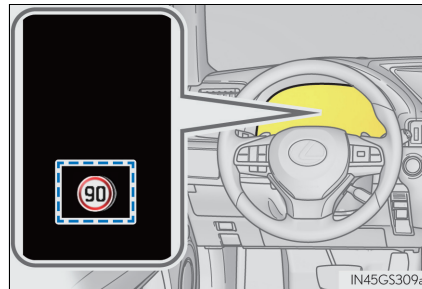







A no overtaking sign and a speed limit sign with supplemental mark are not displayed. However, if signs other than speed limit signs are recognized, they are mentioned in a stack under the current speed limit sign.



Types of recognized road signs

The following types of road signs, including electronic signs and blinking signs, are recognized.

A non-official (not meeting the Vienna Convention) or a recently introduced traffic sign may not be recognized.

Type		Multi-information display
Speed limit begins/ends		
Speed limit with supplemental mark (Displayed simultaneously with speed limit)  (Display example)	Wet	
	Rain	
	Ice	
	On/off ramp* ¹	
	Supplemental mark exists (Contents not recognized)	
No overtaking begins/ends		
No-entry* ²		
All canceled (All restrictions canceled. Returns to default road regulation.)		

*1: If the turn signal indicator is not operated when changing lanes, the mark does not display.

*2: On some models

Warning display

In the following situations, the RSA system alerts the driver using a warning display.

- When the vehicle speed exceeds the speed warning threshold applied to the speed limit of the sign displayed on the multi-information display, the sign color becomes inverted.
- If it is detected that your vehicle is overtaking when a no overtaking sign is displayed on the multi-information display, the sign flashes.
- On some models: When the RSA system recognizes a no-entry sign and detects that the vehicle has entered a no-entry area based on the map information of the navigation system, the no-entry sign flashes.

Depending on the situation, traffic environment (traffic direction, speed, unit) may be detected incorrectly and a warning display may not operate properly.

■ Automatic turn-off of RSA sign display

One or more signs automatically turn off in the following situations.

- A new sign is not recognized for a certain distance.
- The road changes due to a left or right turn, etc.

■ Conditions in which the function may not operate or detect correctly

In the following situations, RSA does not operate normally and may not recognize signs, display the incorrect sign, etc. However, this does not indicate a malfunction.



- The camera sensor is misaligned due to a strong impact being applied to the sensor, etc.
- Dirt, snow, stickers, etc. are on the windshield near the camera sensor.
- In inclement weather such as heavy rain, fog, snow or sand storms
- Light from an oncoming vehicle, the sun, etc. enters the camera sensor.
- The sign is dirty, faded, tilted or bent, and if an electronic sign, the contrast is poor.
- All or part of the sign is hidden by the leaves of a tree, a pole, etc.
- The sign is only visible to the camera sensor for a short amount of time.
- The driving scene (turning, lane change, etc.) is judged incorrectly.
- Even if it is a sign not appropriate for the currently traveled lane, such a sign exists directly after a freeway branches, or in an adjacent lane just before merging.
- Stickers are attached to the rear of the preceding vehicle.
- A sign resembling a system compatible sign is recognized.
- The vehicle is driven in a country with a different direction of traffic.

- Side road speed signs may be detected and displayed (if positioned in sight of the camera sensor) while the vehicle is traveling on the main road.
- Roundabout exit road speed signs may be detected and displayed (if positioned in sight of the camera sensor) while traveling on a roundabout.
- On some models: The speed information displayed on the meter and that displayed on the navigation system may be different due to the navigation system using map data.

■ When driving vehicle in country with different speed unit

Since RSA recognizes signs based on the set unit of the meter, it is necessary to change the set unit of the meter. Adjust the set unit of the meter to the speed unit of signs in the current location. (→P. 565)

■ Turning the system on/off

- 1 Select  RSA on  of the multi-information display (→P. 111)
- 2 Press  on the steering wheel.

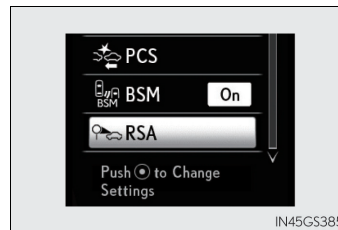

■ Speed limit sign display

If the power switch was last turned off while a speed limit sign was displayed on the multi-information display, the same sign displays again when the power switch is turned to ON mode.

■ Customization

Setting (e.g. speeding warning threshold) can be changed. (Customizable feature: →P. 561)

Dynamic radar cruise control with full-speed range*

Summary of functions

In vehicle-to-vehicle distance control mode, the vehicle automatically accelerates, decelerates and stops to match the speed changes of the preceding vehicle even if the accelerator pedal is not depressed. In constant speed control mode, the vehicle runs at a fixed speed.

Use the dynamic radar cruise control with full-speed range on freeways and highways.

- Vehicle-to-vehicle distance control mode (→P. 299)
- Constant speed control mode (→P. 304)

- ① Vehicle-to-vehicle distance button
- ② Display
- ③ Set speed
- ④ Indicators
- ⑤ Cruise control switch

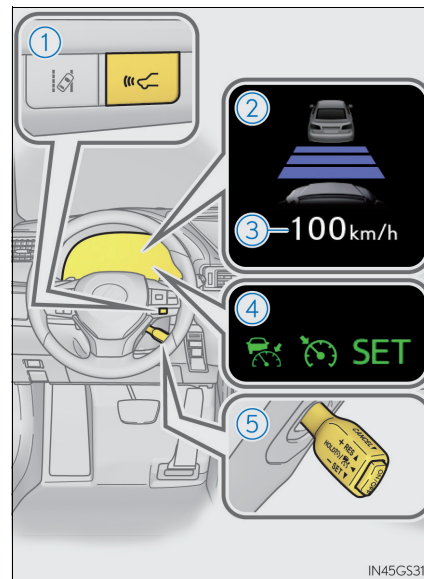

*: If equipped

 **WARNING****■ Before using dynamic radar cruise control with full-speed range**

Driving safely is the sole responsibility of the driver. Do not rely solely on the system, and drive safely by always paying careful attention to your surroundings.

The dynamic radar cruise control with full-speed range provides driving assistance to reduce the driver's burden. However, there are limitations to the assistance provided.

Even when the system is functioning normally, the condition of the preceding vehicle as detected by the system may differ from the condition observed by the driver. Therefore, the driver must always remain alert, assess the danger of each situation and drive safely. Relying on this system or assuming the system ensures safety while driving can lead to an accident, resulting in death or serious injury.

■ Cautions regarding the driving assist systems

Observe the following precautions, as there are limitations to the assistance provided by the system.

Failure to do so may cause an accident resulting in death or serious injury.

● Assisting the driver to measure following distance

The dynamic radar cruise control with full-speed range is only intended to help the driver in determining the following distance between the driver's own vehicle and a designated vehicle traveling ahead. It is not a mechanism that allows careless or inattentive driving, and it is not a system that can assist the driver in low-visibility conditions. It is still necessary for driver to pay close attention to the vehicle's surroundings.

● Assisting the driver to judge proper following distance

The dynamic radar cruise control with full-speed range determines whether the following distance between the driver's own vehicle and a designated vehicle traveling ahead is within a set range. It is not capable of making any other type of judgement. Therefore, it is absolutely necessary for the driver to remain vigilant and to determine whether or not there is a possibility of danger in any given situation.

● Assisting the driver to operate the vehicle

The dynamic radar cruise control with full-speed range has limited capability to prevent or avoid a collision with a vehicle traveling ahead. Therefore, if there is ever any danger, the driver must take immediate and direct control of the vehicle and act appropriately in order to ensure the safety of all involved.

■ To avoid inadvertent dynamic radar cruise control with full-speed range activation

Switch the dynamic radar cruise control with full-speed range off using the "ON/OFF" button when not in use.

 **WARNING****■ Situations unsuitable for dynamic radar cruise control with full-speed range**

Do not use dynamic radar cruise control with full-speed range in any of the following situations.

Doing so may result in inappropriate speed control and could cause an accident resulting in death or serious injury.

- Roads where there are pedestrians, cyclists, etc.
- In heavy traffic
- On roads with sharp bends
- On winding roads
- On slippery roads, such as those covered with rain, ice or snow
- On steep downhills, or where there are sudden changes between sharp up and down gradients
Vehicle speed may exceed the set speed when driving down a steep hill.
- At entrances to freeways and highways
- When weather conditions are bad enough that they may prevent the sensors from detecting correctly (fog, snow, sandstorm, heavy rain, etc.)
- When there is rain, snow, etc. on the front surface of the radar sensor or camera sensor
- In traffic conditions that require frequent repeated acceleration and deceleration
- When your vehicle is towing a trailer (vehicles with towing package) or during emergency towing
- When an approach warning buzzer is heard often

Driving in vehicle-to-vehicle distance control mode

This mode employs a radar sensor to detect the presence of vehicles up to approximately 100 m (328 ft.) ahead, determines the current vehicle-to-vehicle following distance, and operates to maintain a suitable following distance from the vehicle ahead.

Note that vehicle-to-vehicle distance will close in when traveling on long downhill slopes.

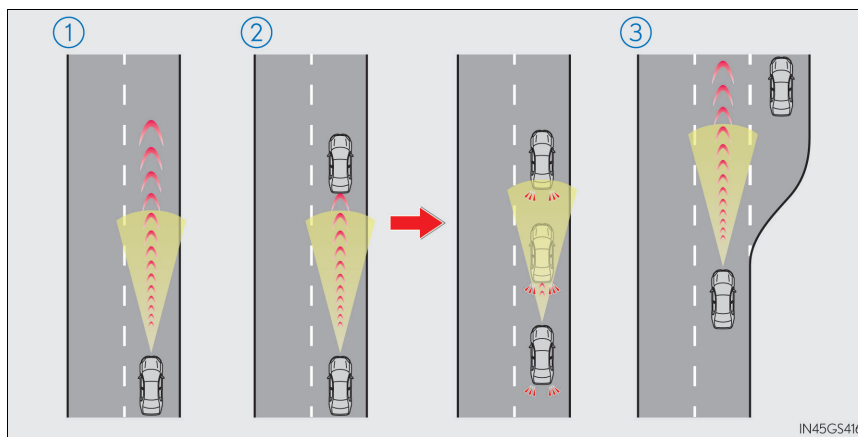

- ① Example of constant speed cruising
When there are no vehicles ahead

The vehicle travels at the speed set by the driver. The desired vehicle-to-vehicle distance can also be set by operating the vehicle-to-vehicle distance button.

- ② Example of deceleration cruising and follow-up cruising
When a preceding vehicle driving slower than the set speed appears

When a vehicle is detected running ahead of you, the system automatically decelerates your vehicle. When a greater reduction in vehicle speed is necessary, the system applies the brakes (the stop lights will come on at this time). The system will respond to changes in the speed of the vehicle ahead in order to maintain the vehicle-to-vehicle distance set by the driver. Approach warning warns you when the system cannot decelerate sufficiently to prevent your vehicle from closing in on the vehicle ahead.

When the vehicle ahead of you stops, your vehicle will also stop (vehicle is stopped by system control). After the vehicle ahead starts off, pushing the cruise control lever up or depressing the accelerator pedal will resume follow-up cruising.

- ③ Example of acceleration
When there are no longer any preceding vehicles driving slower than the set speed

The system accelerates until the set speed is reached. The system then returns to constant speed cruising.

Setting the vehicle speed (vehicle-to-vehicle distance control mode)

- 1 Press the "ON/OFF" button to activate the cruise control.

Radar cruise control indicator will come on and a message will be displayed on the multi-information display.

Press the button again to deactivate the cruise control.

If the "ON/OFF" button is pressed and held for 1.5 seconds or more, the system turns on in constant speed control mode. (→P. 304)

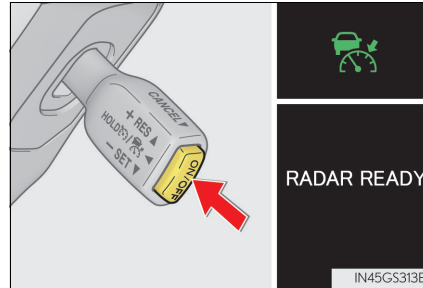

- 2 Accelerate or decelerate, with accelerator pedal operation, to the desired vehicle speed (above approximately 50 km/h [30 mph]) and push the lever down to set the speed.

Cruise control "SET" indicator will come on.

The vehicle speed at the moment the lever is released becomes the set speed.

If the lever is operated while the vehicle speed is below approximately 50 km/h (30 mph) and a preceding vehicle is present, the set speed will be adjusted to approximately 50 km/h (30 mph).

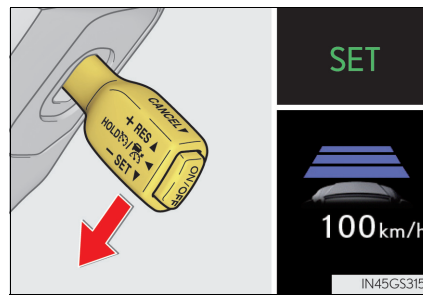

Adjusting the set speed

To change the set speed, operate the lever until the desired set speed is displayed.

① Increases the speed

(Except when the vehicle has been stopped by system control in vehicle-to-vehicle distance control mode)

② Decreases the speed

Fine adjustment: Momentarily move the lever in the desired direction.

Large adjustment: Hold the lever up or down to change the speed, and release when the desired speed is reached.

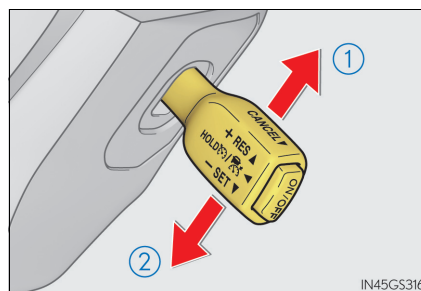

In the vehicle-to-vehicle distance control mode, the set speed will be increased or decreased as follows:

► For Europe

Fine adjustment: By 5 km/h (3.1 mph)^{*1} or 5 mph (8 km/h)^{*2} each time the lever is operated

Large adjustment: Increases or decreases in 5 km/h (3.1 mph)^{*1} or 5 mph (8 km/h)^{*2} increments for as long as the lever is held

► Except for Europe

Fine adjustment: By 1 km/h (0.6 mph)^{*1} or 1 mph (1.6 km/h)^{*2} each time the lever is operated

Large adjustment: Increases or decreases in 5 km/h (3.1 mph)^{*1} or 5 mph (8 km/h)^{*2} increments for as long as the lever is held

In the constant speed control mode (→P. 304), the set speed will be increased or decreased as follows:

Fine adjustment: By 1 km/h (0.6 mph)^{*1} or 1 mph (1.6 km/h)^{*2} each time the lever is operated

Large adjustment: The speed will continue to change while the lever is held.

*1: When the set speed is shown in "km/h"

*2: When the set speed is shown in "MPH"

Changing the vehicle-to-vehicle distance (vehicle-to-vehicle distance control mode)

Pressing the button changes the vehicle-to-vehicle distance as follows:

- ① Long
- ② Medium
- ③ Short

The vehicle-to-vehicle distance is set automatically to long mode when the power switch is turned ON mode.

If a vehicle is running ahead of you, the preceding vehicle mark will also be displayed.

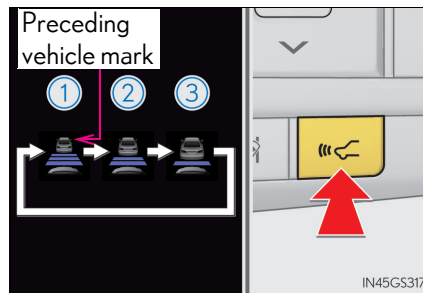

Vehicle-to-vehicle distance settings (vehicle-to-vehicle distance control mode)

Select a distance from the table below. Note that the distances shown correspond to a vehicle speed of 80 km/h (50 mph). Vehicle-to-vehicle distance increases/decreases in accordance with vehicle speed. When the vehicle is stopped by system control, the vehicle-to-vehicle distance will be about 3 m (10 ft.) to 5 m (16 ft.) regardless of the vehicle-to-vehicle distance setting.

Distance options	Vehicle-to-vehicle distance
Long	Approximately 50 m (160 ft.)
Medium	Approximately 40 m (130 ft.)
Short	Approximately 30 m (100 ft.)

Resuming follow-up cruising when the vehicle has been stopped by system control (vehicle-to-vehicle distance control mode)

After the vehicle ahead of you starts off, push the lever up.

Your vehicle will also resume follow-up cruising if the accelerator pedal is depressed after the vehicle ahead of you starts off.

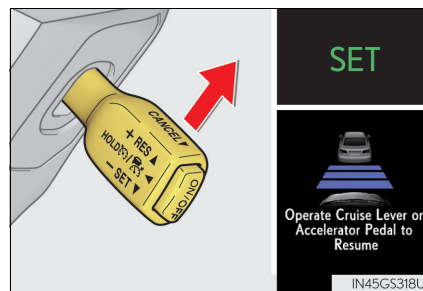

Canceling and resuming the speed control

- ① Pulling the lever toward you cancels the speed control.

The speed control is also canceled when the brake pedal is depressed.

(When the vehicle has been stopped by system control, depressing the brake pedal does not cancel the setting.)

- ② Pushing the lever up resumes the cruise control and returns vehicle speed to the set speed.

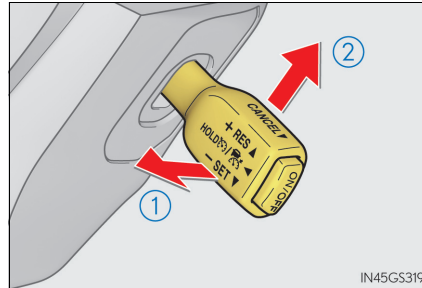

However, when a vehicle ahead is not detected, cruise control does not resume when the vehicle speed is approximately 40 km/h (25 mph) or less.

Approach warning (vehicle-to-vehicle distance control mode)

When your vehicle is too close to a vehicle ahead, and sufficient automatic deceleration via the cruise control is not possible, the display will flash and the buzzer will sound to alert the driver. An example of this would be if another driver cuts in front of you while you are following a vehicle. Depress the brake pedal to ensure an appropriate vehicle-to-vehicle distance.

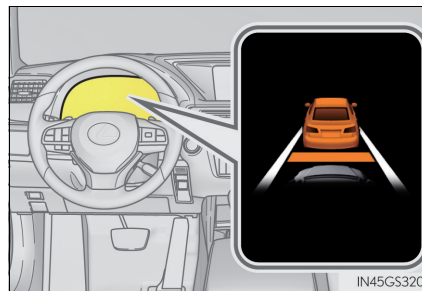

■ Warnings may not occur when

In the following instances, warnings may not occur even when the vehicle-to-vehicle distance is small.

- When the speed of the preceding vehicle matches or exceeds your vehicle speed
- When the preceding vehicle is traveling at an extremely slow speed
- Immediately after the cruise control speed was set
- When depressing the accelerator pedal

Selecting constant speed control mode

When constant speed control mode is selected, your vehicle will maintain a set speed without controlling the vehicle-to-vehicle distance. Select this mode only when vehicle-to-vehicle distance control mode does not function correctly due to a dirty radar sensor, etc.

- 1 With the cruise control off, press and hold the “ON/OFF” button for 1.5 seconds or more.

Immediately after the “ON/OFF” button is pressed, the radar cruise control indicator will come on. Afterwards, it switches to the cruise control indicator.

Switching to constant speed control mode is only possible when operating the lever with the cruise control off.

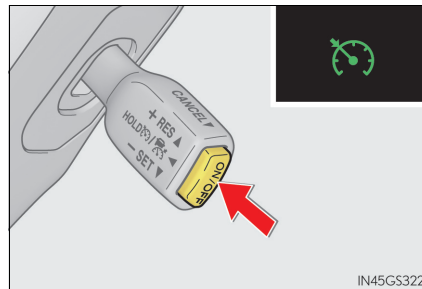

- 2 Accelerate or decelerate, with accelerator pedal operation, to the desired vehicle speed (above approximately 50 km/h [30 mph]) and push the lever down to set the speed.

Cruise control “SET” indicator will come on.

The vehicle speed at the moment the lever is released becomes the set speed.

Adjusting the speed setting: →P. 301

Canceling and resuming the speed setting: →P. 303

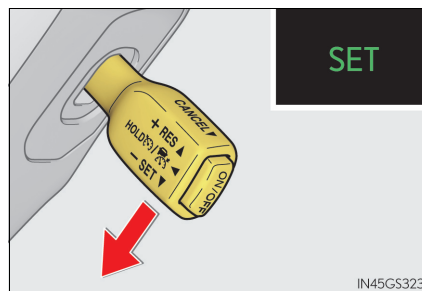

■ Dynamic radar cruise control with full-speed range can be set when

- The shift lever is in D or range 4 or higher of S has been selected.
- Range 4 or higher of D has been selected by using the paddle shift switch.
- Vehicle speed is above approximately 50 km/h (30 mph).
However, when a preceding vehicle is detected, the dynamic radar cruise control with full-speed range can be set even if the vehicle speed is at or below approximately 50 km/h (30 mph).

■ Accelerating after setting the vehicle speed

The vehicle can accelerate by operating the accelerator pedal. After accelerating, the set speed resumes. However, during vehicle-to-vehicle distance control mode, the vehicle speed may decrease below the set speed in order to maintain the distance to the preceding vehicle.

■ Automatic cancelation of vehicle-to-vehicle distance control mode

Vehicle-to-vehicle distance control mode is automatically canceled in the following situations.

- Actual vehicle speed falls below approximately 40 km/h (25 mph) when there are no vehicles ahead.
- The preceding vehicle leaves the lane when your vehicle is following at a vehicle speed below approximately 40 km/h (25 mph). Otherwise, the sensor can not properly detect the vehicle.
- VSC is activated.
- TRC is activated for a period of time.
- When the VSC or TRC system is turned off by pressing the VSC OFF switch.
- When snow mode is set.
- The sensor cannot detect correctly because it is covered in some way.
- Pre-crash braking is activated.
- The parking brake is operated.
- The vehicle is stopped by system control on a steep incline.
- The following are detected when the vehicle has been stopped by system control:
 - The driver is not wearing a seat belt.
 - The driver's door is opened.
 - The vehicle has been stopped for about 3 minutes

If vehicle-to-vehicle distance control mode is automatically canceled for any other reason, there may be a malfunction in the system. Contact any authorized Lexus retailer or Lexus authorized repairer, or any reliable repairer.

■ **Automatic cancelation of constant speed control mode**

Constant speed control mode is automatically canceled in the following situations:

- Actual vehicle speed is more than approximately 16 km/h (10 mph) below the set vehicle speed.
- Actual vehicle speed falls below approximately 40 km/h (25 mph).
- VSC is activated.
- TRC is activated for a period of time.
- When the VSC or TRC system is turned off by pressing the VSC OFF switch.
- Pre-crash braking is activated.

If constant speed control mode is automatically canceled for any other reason, there may be a malfunction in the system. Contact any authorized Lexus retailer or Lexus authorized repairer, or any reliable repairer.

■ **Warning messages and buzzers for dynamic radar cruise control with full-speed range**

Warning messages and buzzers are used to indicate a system malfunction or to inform the driver of the need for caution while driving. If a warning message is shown on the multi-information display, read the message and follow the instructions. (→P. 466)

■ **When the sensor may not be correctly detecting the vehicle ahead**

In the case of the following and depending on the conditions, operate the brake pedal when deceleration of the system is insufficient or operate the accelerator pedal when acceleration is required.

As the sensor may not be able to correctly detect these types of vehicles, the approach warning (→P. 303) may not be activated.

- Vehicles that cut in suddenly
- Vehicles traveling at low speeds
- Vehicles that are not moving in the same lane
- Vehicles with small rear ends (trailers with no load on board, etc.)

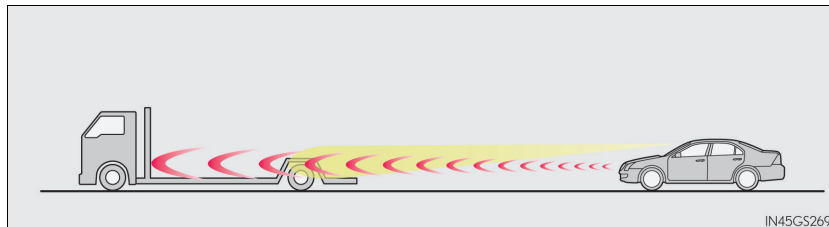

- Motorcycles traveling in the same lane
- When water or snow thrown up by the surrounding vehicles hinders the detecting of the sensor

- When your vehicle is pointing upwards (caused by a heavy load in the luggage compartment, etc.)

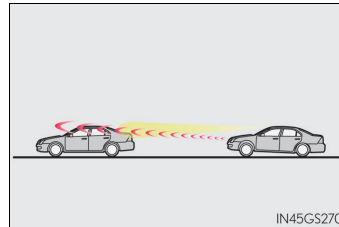

- Preceding vehicle has an extremely high ground clearance

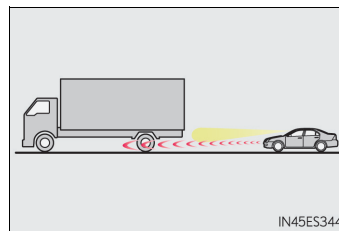

■ Conditions under which the vehicle-to-vehicle distance control mode may not function correctly

In the case of the following conditions, operate the brake pedal (or accelerator pedal, depending on the situation) as necessary.

As the sensor may not be able to correctly detect vehicles ahead, the system may not operate properly.

- When the road curves or when the lanes are narrow

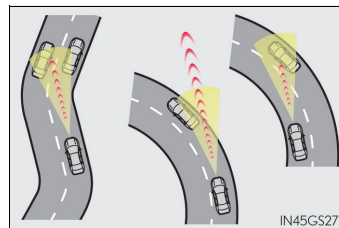

- When steering wheel operation or your position in the lane is unstable

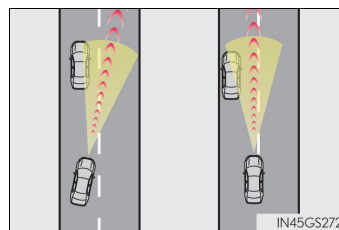

- When the vehicle ahead of you decelerates suddenly

Cruise control*

Summary of functions

Use the cruise control to maintain a set speed without depressing the accelerator pedal.

- ① Set speed
- ② Indicators
- ③ Cruise control switch

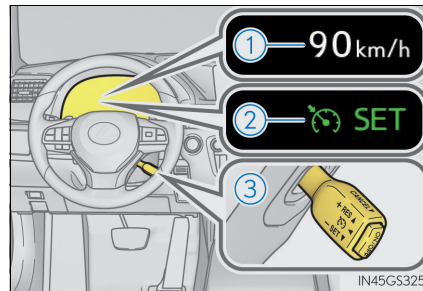

Setting the vehicle speed

- 1 Press the “ON/OFF” button to activate the cruise control.
Cruise control indicator will come on.
Press the button again to deactivate the cruise control.

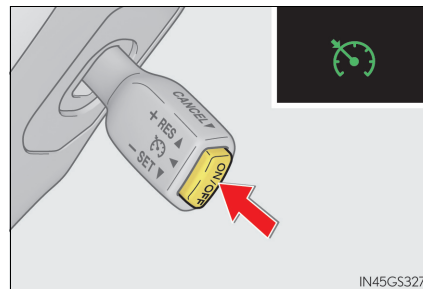

- 2 Accelerate or decelerate the vehicle to the desired speed, and push the lever down to set the speed.
Cruise control “SET” indicator will come on.
The vehicle speed at the moment the lever is released becomes the set speed.

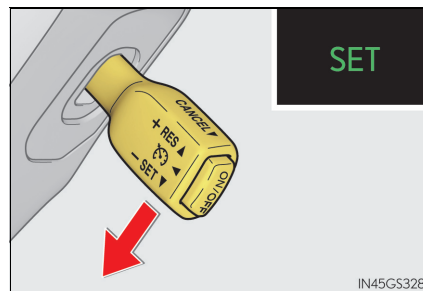

*: If equipped

Adjusting the set speed

To change the set speed, operate the lever until the desired set speed is obtained.

- ① Increases the speed
- ② Decreases the speed

Fine adjustment: Momentarily move the lever in the desired direction.

Large adjustment: Hold the lever in the desired direction.

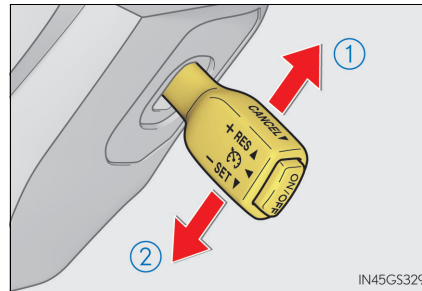

The set speed will be increased or decreased as follows:

Fine adjustment: By approximately 1.6 km/h (1 mph) each time the lever is operated.

Large adjustment: The set speed can be increased or decreased continually until the lever is released.

Canceling and resuming the constant speed control

- ① Pulling the lever toward you cancels the constant speed control.
The speed setting is also canceled when the brakes are applied.
- ② Pushing the lever up resumes the constant speed control.

Resuming is available when the vehicle speed is more than approximately 40 km/h (25 mph).

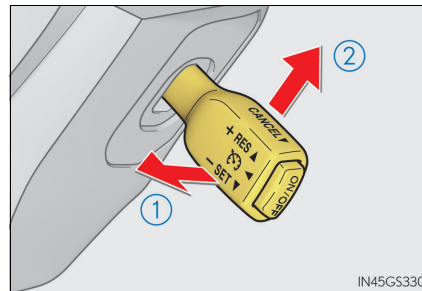

■ Cruise control can be set when

- The shift lever is in D or range 4 or higher of S has been selected.
- Range 4 or higher of D has been selected by using the paddle shift.
- Vehicle speed is above approximately 40 km/h (25 mph).

■ Accelerating after setting the vehicle speed

- The vehicle can be accelerated normally. After acceleration, the set speed resumes.
- Even without canceling the cruise control, the set speed can be increased by first accelerating the vehicle to the desired speed and then pushing the lever down to set the new speed.

■ **Automatic cruise control cancelation**

Cruise control will stop maintaining the vehicle speed in any of the following situations.

- Actual vehicle speed falls more than approximately 16 km/h (10 mph) below the preset vehicle speed.
At this time, the memorized set speed is not retained.
- Actual vehicle speed is below approximately 40 km/h (25 mph).
- VSC is activated.
- TRC is activated for a period of time.
- When the VSC or TRC system is turned off by pressing the VSC OFF switch.

■ **If the warning message for the cruise control is shown on the multi-information display**

Press the "ON/OFF" button once to deactivate the system, and then press the button again to reactivate the system.

If the cruise control speed cannot be set or if the cruise control cancels immediately after being activated, there may be a malfunction in the cruise control system. Have the vehicle inspected by any authorized Lexus retailer or Lexus authorized repairer, or any reliable repairer.

 **WARNING**

■ **To avoid operating the cruise control by mistake**

Switch the cruise control off using the "ON/OFF" button when not in use.

■ **Situations unsuitable for cruise control**

Do not use cruise control in any of the following situations.

Doing so may result in loss of control and could cause an accident resulting in death or serious injury.

- In heavy traffic
- On roads with sharp bends
- On winding roads
- On slippery roads, such as those covered with rain, ice or snow
- On steep hills
Vehicle speed may exceed the set speed when driving down a steep hill.
- When your vehicle is towing a trailer or during emergency towing

Driving mode select switch

The driving modes can be selected to suit driving condition.

- ▶ Vehicles without Adaptive Variable Suspension system

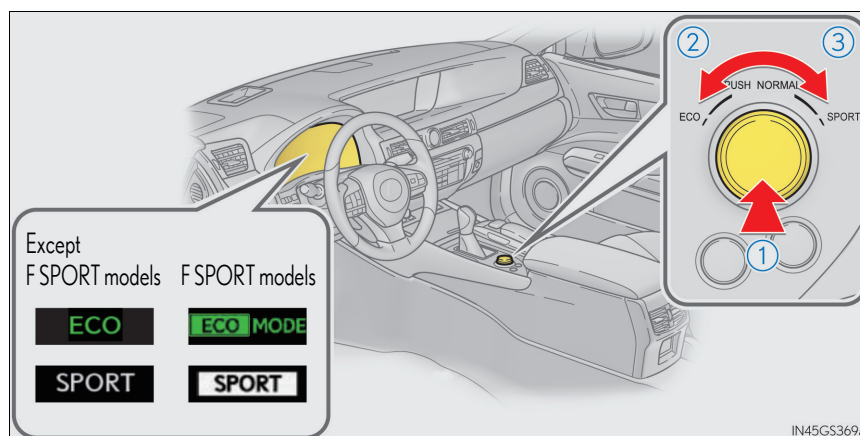

- ① Normal mode
For normal driving.
Press the switch to change the driving mode to normal mode when Eco drive mode or sport mode is selected.
- ② Eco drive mode
Use Eco drive mode to help achieve low fuel consumption during trips that involve frequent accelerating.
When not in Eco drive mode and the driving mode select switch is turned to the left, the "ECO" or "ECO MODE" indicator comes on in the multi-information display.
- ③ Sport mode
Assists acceleration response by controlling the hybrid system and steering. Suitable for when precise handling is desirable, for example when driving on mountain roads.
When not in Sport mode and the driving mode select switch is turned to the right, the "SPORT" indicator comes on in the multi-information display, and the Hybrid System Indicator changes to the tachometer. (→P. 109)

▶ Vehicles with Adaptive Variable Suspension system

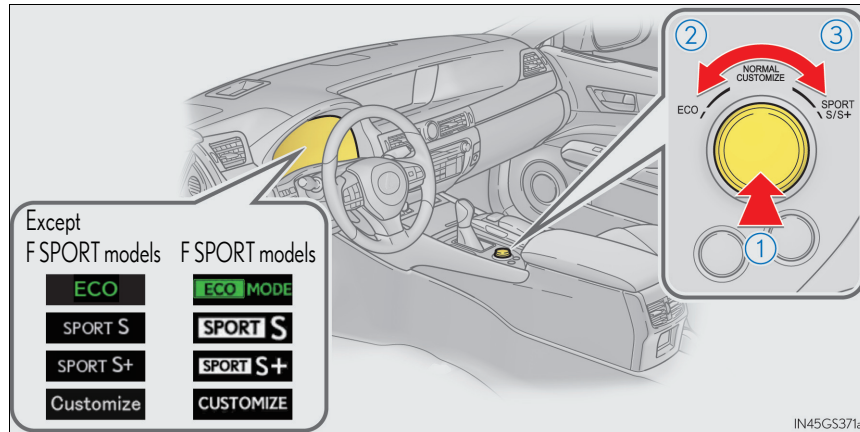

① Normal mode/Customized mode

Normal mode and customized mode are selected by pressing the driving mode select switch. Each time the switch is pressed, the driving mode changes between normal mode and customized mode. When customized mode is selected, the “Customize” or “CUSTOMIZE” indicator will be illuminated.

Press the switch to change the driving mode to normal mode when Eco drive mode or sport mode is selected.

- Normal mode
For normal driving.
- Customized mode
Allows you to drive with the power train, chassis and air conditioning system functions set to your preferred settings.
Customized mode settings can only be changed on the drive mode customization display of the Remote Touch screen. (→P. 570)

② Eco drive mode

Use Eco drive mode to help achieve low fuel consumption during trips that involve frequent accelerating.

When not in Eco drive mode and the driving mode select switch is turned to the left, the “ECO” or “ECO MODE” indicator comes on in the multi-information display.

③ Sport mode

• SPORT S mode

Assists acceleration response by controlling the transmission and engine.

When not in SPORT S mode and the driving mode select switch is turned to the right, the "SPORT S" indicator comes on in the multi-information display, and the Hybrid System Indicator changes to the tachometer. (→P. 109)

• SPORT S+ mode

Helps to ensure steering performance and driving stability by simultaneously controlling the steering and suspension in addition to the hybrid system. Suitable for sporty driving.

When in SPORT S mode and the driving mode select switch is turned to the right, the "SPORT S+" indicator comes on in the multi-information display.

■ **Operation of the air conditioning system in Eco drive mode**

Eco drive mode controls the heating/cooling operations and fan speed of the air conditioning system to enhance fuel efficiency (→P. 346). To improve air conditioning performance, adjust the fan speed or turn off Eco drive mode.

■ **Automatic operation of the seat heater during Eco drive mode**

Eco drive mode controls the heating operation and fan speed of the air conditioning system to enhance fuel efficiency. If the driving mode select switch is switched to Eco drive mode in cold temperatures, the seat heater will be automatically operated to assist heating performance.

■ **Automatic deactivation of sport mode and customized mode**

If the power switch is turned off after driving in sport mode or customized mode, the drive mode will be changed to normal mode.

■ **Driving mode pop-up display (12.3-inch display only)**

When the driving mode is changed, the selected driving mode will be temporarily displayed on the side display. (→P. 344)

BSM (Blind Spot Monitor)*

Summary of the Blind Spot Monitor

The Blind Spot Monitor is a system that has 2 functions;

- The Blind Spot Monitor function
Assists the driver in making the decision when changing lanes
- The Rear Crossing Traffic Alert function
Assists the driver when backing up

These functions use same sensors.

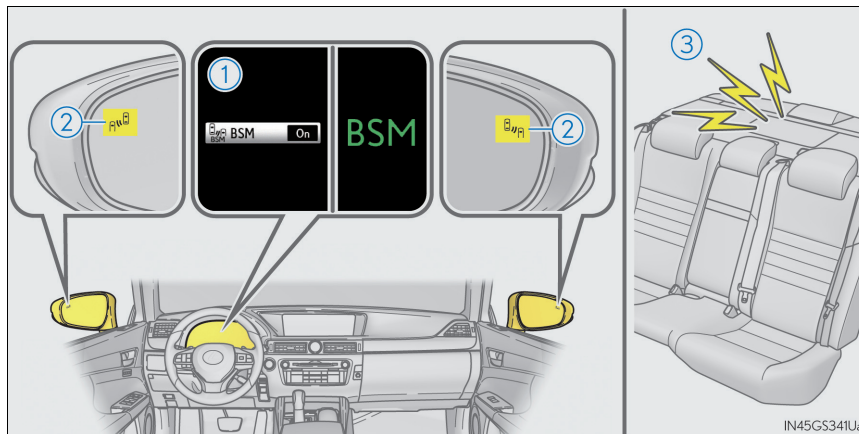

① Switching the BSM function

The Blind Spot Monitor function and Rear Crossing Traffic Alert function can be switched on and off using the multi-information display. (→P. 315)

When switched on, the BSM indicator illuminates on the meter and the buzzer sounds.

② Outside rear view mirror indicators

Blind Spot Monitor function:

When a vehicle is detected in the blind spot, the outside rear view mirror indicator comes on while the turn signal lever is not operated. If the turn signal lever is operated toward the detected side, the outside rear view mirror indicator flashes.

Rear Crossing Traffic Alert function:

When a vehicle approaching from the right or left rear of the vehicle is detected, the outside rear view mirror indicators flash.

③ Rear Crossing Traffic Alert buzzer (Rear Crossing Traffic Alert function only)

When a vehicle approaching from the right or left rear of the vehicle is detected, a buzzer sounds from behind the rear seat.

*: If equipped

■ The outside rear view mirror indicators visibility

When under strong sunlight, the outside rear view mirror indicator may be difficult to see.

■ Rear Crossing Traffic Alert buzzer hearing

Rear Crossing Traffic Alert function may be difficult to hear over loud noises such as high audio volume.



■ When there is a malfunction in the Blind Spot Monitor

If a system malfunction is detected due to any of the following reasons, warning messages will be displayed: (→P. 466)

- There is a malfunction with the sensors
- The sensors have become dirty
- The outside temperature is extremely high or low
- The sensor voltage has become abnormal

■ Switching the Blind Spot Monitor function and Rear Crossing Traffic Alert function on and off

Settings can be changed from  on the multi-information display (→P. 111).

- 1 Press  or  on the meter control switch and select "BSM".
- 2 Each time  on the meter control switch is pressed, the function switches between "On" and "Off".

■ Certification for the Blind Spot Monitor

CE 0700

The latest "DECLARATION of CONFORMITY"(DoC) is available at the following:

DoC address : <http://continental.automotive-approvals.de/index.php?produkt=SRR2-A>

<p>CONTINENTAL tímto prohlašuje, že tento SRR2-A je ve shodě se základními požadavky a dalšími příslušnými ustanoveními směrnice 1999/5/ES.</p>
<p>Undertegnede CONTINENTAL erklærer herved, at følgende udstyr SRR2-A overholder de væsentlige krav og øvrige relevante krav i direktiv 1999/5/EF.</p>
<p>Hiermit erklärt CONTINENTAL, dass sich das Gerät SRR2-A in Übereinstimmung mit den grundlegenden Anforderungen und den übrigen einschlägigen Bestimmungen der Richtlinie 1999/5/EG befindet.</p>
<p>Käesolevaga kinnitab CONTINENTAL seadme SRR2-A vastavust direktiivi 1999/5/EÜ põhinõuetele ja nimetatud direktiivist tulenevatele teistele asjakohastele sätetele.</p>
<p>Hereby, CONTINENTAL, declares that this SRR2-A is in compliance with the essential requirements and other relevant provisions of Directive 1999/5/EC.</p>
<p>Por medio de la presente CONTINENTAL declara que el SRR2-A cumple con los requisitos esenciales y cualesquiera otras disposiciones aplicables o exigibles de la Directiva 1999/5/CE.</p>
<p>ΜΕ ΤΗΝ ΠΑΡΟΥΣΑ CONTINENTAL ΔΗΛΩΝΕΙ ΟΤΙ SRR2-A ΣΥΜΜΟΡΦΩΝΕΤΑΙ ΠΡΟΣ ΤΙΣ ΟΥΣΙΩΔΕΙΣ ΑΠΑΙΤΗΣΕΙΣ ΚΑΙ ΤΙΣ ΛΟΙΠΕΣ ΣΧΕΤΙΚΕΣ ΔΙΑΤΑΞΕΙΣ ΤΗΣ ΟΔΗΓΙΑΣ 1999/5/EK.</p>
<p>Par la présente CONTINENTAL déclare que l'appareil SRR2-A est conforme aux exigences essentielles et aux autres dispositions pertinentes de la directive 1999/5/CE.</p>
<p>Con la presente CONTINENTAL dichiara che questo SRR2-A è conforme ai requisiti essenziali ed alle altre disposizioni pertinenti stabilite dalla direttiva 1999/5/CE.</p>
<p>Ar šo CONTINENTAL deklarē, ka SRR2-A atbilst Direktīvas 1999/5/EK būtiskajām prasībām un citiem ar to saistītajiem noteikumiem.</p>
<p>Šiuo CONTINENTAL deklaruoja, kad šis SRR2-A atitinka esminius reikalavimus ir kitas 1999/5/EB Direktyvos nuostatas.</p>
<p>Hierbij verklaart CONTINENTAL dat het toestel SRR2-A in overeenstemming is met de essentiële eisen en de andere relevante bepalingen van richtlijn 1999/5/EG.</p>
<p>Hawnhekk, CONTINENTAL, jiddikjara li dan SRR2-A jikkonforma mal-htigijiet essenzjali u ma provvedimenti oħrajn relevanti li hemm fid-Direttiva 1999/5/EC.</p>

Alulírott, CONTINENTAL nyilatkozom, hogy a SRR2-A megfelel a vonatkozó alapvető követelményeknek és az 1999/5/EC irányelv egyéb előírásainak.
Niniejszym CONTINENTAL oświadcza, że SRR2-A jest zgodny z zasadniczymi wymogami oraz pozostałymi stosownymi postanowieniami Dyrektywy 1999/5/EC.
CONTINENTAL declara que este SRR2-A está conforme com os requisitos essenciais e outras disposições da Directiva 1999/5/CE.
CONTINENTAL izjavlja, da je ta SRR2-A v skladu z bistvenimi zahtevami in ostalimi relevantnimi določili direktive 1999/5/ES.
CONTINENTAL tímto vyhlasuje, že SRR2-A splňa základné požiadavky a všetky príslušné ustanovenia Smernice 1999/5/ES.
CONTINENTAL vakuuttaa täten että SRR2-A tyypinen laite on direktiivin 1999/5/EY oleellisten vaatimusten ja sitä koskevien direktiivin muiden ehtojen mukainen.
Härmed intygar CONTINENTAL att denna SRR2-A står i överensstämmelse med de väsentliga egenskapskrav och övriga relevanta bestämmelser som framgår av direktiv 1999/5/EG.
Hér með lýsir CONTINENTAL yfir því að SRR2-A er í samræmi við grunnkröfur og aðrar kröfur, sem gerðar eru í tilskipun 1999/5/EC.
CONTINENTAL erklærer herved at utstyret SRR2-A er i samsvar med de grunnleggende krav og øvrige relevante krav i direktiv 1999/5/EF.
С настоящето, CONTINENTAL, декларира, че SRR2-A е в съответствие със съществените изисквания и другите приложими разпоредби на Директива 1999/5/EC.
Prin prezenta, CONTINENTAL, declară că aparatul SRR2-A este în conformitate cu cerințele esențiale și cu alte prevederi pertinente ale Directivei 1999/5/CE.
"Ovim , CONTINENTAL, izjavljuje da ovaj SRR2-A je usklađen sa bitnim zahtjevima i drugim relevantnim odredbama Direktive 1999/5/EC."
Ovim CONTINENTAL, izjavljuje da je SRR2-A u skladu s bitnim zahtjevima i drugim relevantnim odredbama Direktive 1999/5/EC i Pravilnika o RiTT opremi(NN25/2012)

► For vehicles sold in Ukraine

type approval number : 1O094.000966-13



155

⚠ WARNING

■ Handling the radar sensor

One Blind Spot Monitor sensor is installed inside the left and right side of the vehicle rear bumper respectively. Observe the following to ensure the Blind Spot Monitor can function correctly.

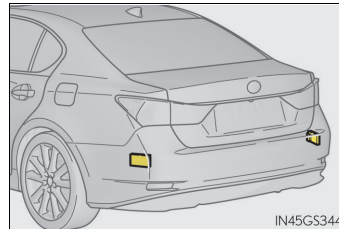

- Keep the sensor and its surrounding area on the bumper clean at all times.
- Do not subject the sensor or surrounding area on the bumper to a strong impact. If the sensor moves even slightly off position, the system may malfunction and vehicles that enter the detection area may not be detected. If the sensor or surrounding area is subject to a strong impact, always have the area inspected by any authorized Lexus retailer or Lexus authorized repairer, or any reliable repairer.
- Do not disassemble the sensor.
- Do not attach accessories or stickers to the sensor or surrounding area on the bumper.
- Do not modify the sensor or surrounding area on the bumper.
- Do not paint the rear bumper any color other than an official Lexus color.

The Blind Spot Monitor function

The Blind Spot Monitor function uses radar sensors to detect vehicles that are traveling in an adjacent lane in the area that is not reflected in the outside rear view mirror (the blind spot), and advises the driver of the vehicle's existence via the outside rear view mirror indicator.

The Blind Spot Monitor function detection areas

The areas that vehicles can be detected in are outlined below.

The range of the detection area extends to:

- ① Approximately 3.5 m (11.5 ft.) from the side of the vehicle
The first 0.5 m (1.6 ft.) from the side of the vehicle is not in the detection area
- ② Approximately 3 m (9.8 ft.) from the rear bumper
- ③ Approximately 1 m (3.3 ft.) forward of the rear bumper

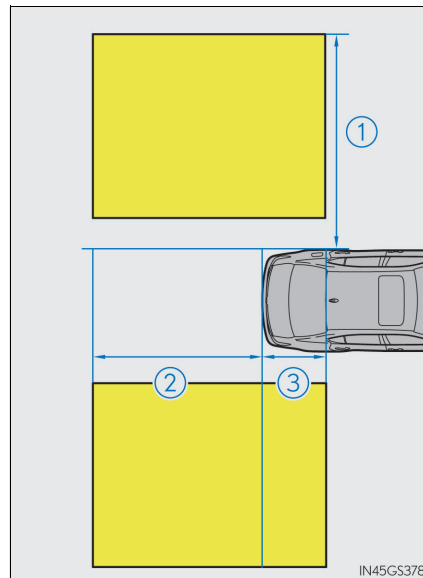

WARNING

■ Cautions regarding the use of the system

The driver is solely responsible for safe driving. Always drive safely, taking care to observe your surroundings.

The Blind Spot Monitor function is a supplementary function which alerts the driver that a vehicle is present in the blind spot. Do not overly rely on the Blind Spot Monitor function. The function cannot judge if it is safe to change lanes, therefore over reliance could cause an accident resulting in death or serious injury.

According to conditions, the system may not function correctly. Therefore the driver's own visual confirmation of safety is necessary.

■ The Blind Spot Monitor function is operational when

- The BSM function is turned on.
- Vehicle speed is greater than approximately 16 km/h (10 mph).

■ The Blind Spot Monitor function will detect a vehicle when

- A vehicle in an adjacent lane overtakes your vehicle.
- Another vehicle enters the detection area when it changes lanes.

■ Conditions under which the Blind Spot Monitor function will not detect a vehicle

The Blind Spot Monitor function is not designed to detect the following types of vehicles and/or objects:

- Small motorcycles, bicycles, pedestrians etc.*
- Vehicles traveling in the opposite direction
- Guardrails, walls, signs, parked vehicles and similar stationary objects*
- Following vehicles that are in the same lane*
- Vehicles driving 2 lanes across from your vehicle*

*: Depending on conditions, detection of a vehicle and/or object may occur.

■ Conditions under which the Blind Spot Monitor function may not function correctly

- The Blind Spot Monitor function may not detect vehicles correctly in the following conditions:
 - During bad weather such as heavy rain, fog, snow etc.
 - When ice or mud etc. is attached to the rear bumper
 - When driving on a road surface that is wet due to rain, standing water etc.
 - When there is a significant difference in speed between your vehicle and the vehicle that enters the detection area
 - When a vehicle is in the detection area from a stop and remains in the detection area as your vehicle accelerates
 - When driving up or down consecutive steep inclines, such as hills, a dip in the road etc.
 - When multiple vehicles approach with only a small gap between each vehicle
 - When vehicle lanes are wide, and the vehicle in the next lane is too far away from your vehicle
 - When the vehicle that enters the detection area is traveling at about the same speed as your vehicle
 - When there is a significant difference in height between your vehicle and the vehicle that enters the detection area
 - Directly after the BSM function is turned on
 - When your vehicle is towing a trailer (vehicles with towing package)
- Instances of the Blind Spot Monitor function unnecessarily detecting a vehicle and/ or object may increase under the following conditions:
 - When there is only a short distance between your vehicle and a guardrail, wall etc.
 - When there is only a short distance between your vehicle and a following vehicle
 - When vehicle lanes are narrow and a vehicle driving 2 lanes across from your vehicle enters the detection area
 - When items such as a bicycle carrier are installed on the rear of the vehicle

The Rear Crossing Traffic Alert function

The Rear Crossing Traffic Alert functions when your vehicle is in reverse. It can detect other vehicles approaching from the right or left rear of the vehicle. It uses radar sensors to alert the driver of the other vehicle's existence through flashing the outside rear view mirror indicators and sounding a buzzer.

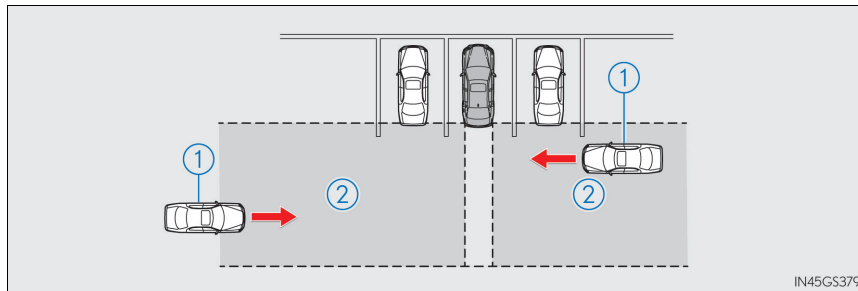

① Approaching vehicles

② Detection areas

⚠ WARNING

■ Cautions regarding the use of the system

The driver is solely responsible for safe driving. Always drive safely, taking care to observe your surroundings.

The Rear Crossing Traffic Alert function is only an assist and is not a replacement for careful driving. The driver must be careful when backing up, even when using the Rear Crossing Traffic Alert function. The driver's own visual confirmation of behind you and your vehicle is necessary and be sure there are no pedestrians, other vehicles etc. before backing up. Failure to do so could cause death or serious injury.

According to conditions, the system may not function correctly. Therefore the driver's own visual confirmation of safety is necessary.

The Rear Crossing Traffic Alert function detection areas

The areas that vehicles can be detected in are outlined below.

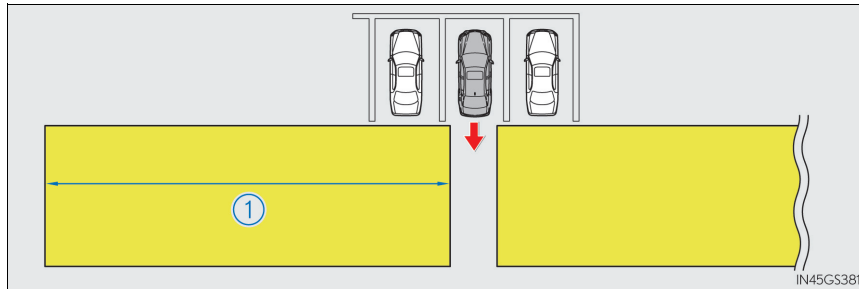

To give the driver a more consistent time to react, the buzzer can alert for faster vehicles from farther away.

Example:

Approaching vehicle	Speed	① Approximate alert distance
Fast	28 km/h (18 mph)	20 m (65 ft.)
Slow	8 km/h (5 mph)	5.5 m (18 ft.)

■ **The Rear Crossing Traffic Alert function is operational when**

- The BSM function is turned on.
- The shift lever is in R.
- Vehicle speed is less than approximately 8 km/h (5 mph).
- Approaching vehicle speed is between approximately 8 km/h (5 mph) and 28 km/h (18 mph).

■ Conditions under which the Rear Crossing Traffic Alert function will not detect a vehicle

The Rear Crossing Traffic Alert function is not designed to detect the following types of vehicles and/or objects.

- Small motorcycles, bicycles, pedestrians etc. *
- Vehicles approaching from directly behind
- Guardrails, walls, signs, parked vehicles and similar stationary objects *
- Vehicles moving away from your vehicle
- Vehicles approaching from the parking spaces next to your vehicle *
- Vehicles backing up in the parking space next to your vehicle *

*: Depending on conditions, detection of a vehicle and/or object may occur.

■ Conditions under which the Rear Crossing Traffic Alert function may not function correctly

The Rear Crossing Traffic Alert function may not detect vehicles correctly in the following conditions:

- During bad weather such as heavy rain, fog, snow etc.
- When ice or mud etc. is attached to the rear bumper
- When multiple vehicles approach continuously
- Shallow angle parking
- When a vehicle is approaching at high speed
- When parking on a steep incline, such as hills, a dip in the road etc.
- Directly after the BSM function is turned on
- When your vehicle is towing a trailer (vehicles with towing package)
- When items such as a bicycle carrier are installed on the rear of the vehicle
- Directly after the hybrid system is started with the BSM function is turned on
- When the sensors cannot detect vehicles because of obstacles

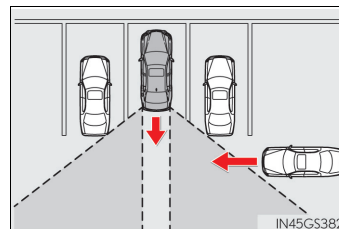

Driving assist systems

To help enhance driving safety and performance, the following systems operate automatically in response to various driving situations. Be aware, however, that these systems are supplementary and should not be relied upon too heavily when operating the vehicle.

◆ ECB (Electronically Controlled Brake System)

The electronically controlled system generates braking force corresponding to the brake operation

◆ ABS (Anti-lock Brake System)

Helps to prevent wheel lock when the brakes are applied suddenly, or if the brakes are applied while driving on a slippery road surface

◆ Brake assist

Generates an increased level of braking force after the brake pedal is depressed when the system detects a panic stop situation

◆ VSC (Vehicle Stability Control)

Helps the driver to control skidding when swerving suddenly or turning on slippery road surfaces

◆ TRC (Traction Control)

Helps to maintain drive power and prevent the drive wheels from spinning when starting the vehicle or accelerating on slippery roads

◆ VGRS (Variable Gear Ratio Steering) (if equipped)

Adjusts the front wheel turning angle in accordance with the vehicle speed and steering wheel movement

◆ DRS (Dynamic Rear Steering) (if equipped)

Contributes to the turning characteristics and responsiveness of the vehicle by slightly adjusting the rear wheel angle of the vehicle in accordance with steering wheel movement

◆ Hill-start assist control

Helps to prevent the vehicle from rolling backward when starting on an incline.

◆ EPS (Electric Power Steering)

Employs an electric motor to reduce the amount of effort needed to turn the steering wheel

◆ AVS (Adaptive Variable Suspension system) (if equipped)

By independently controlling the damping force of the shock absorbers for each of the 4 wheels according to the road and driving conditions, this system helps riding comfort with a high level of stability, and helps good vehicle posture

When SPORT S+ mode is selected by the driving mode select switch, the damping force is suitable for sporty driving (→P. 312)

◆ LDH (Lexus Dynamic Handling system) (if equipped)

Provides independent control of the VGRS, DRS and EPS. Contributes to turning characteristics at low speeds, responsiveness at medium speeds and safety at high speeds by controlling the steering angle of the front and rear wheels in accordance with the steering wheel operation and vehicle speed

◆ VDIM (Vehicle Dynamics Integrated Management)

Provides integrated control of the ABS, brake assist, TRC, VSC, hill-start assist control, EPS, VGRS (if equipped) and DRS (if equipped) systems

Helps to maintain vehicle stability when swerving on slippery road surfaces by controlling the brakes, hybrid system output, steering assist, steering ratio and rear wheel angle

◆ Emergency brake signal

When the brakes are applied suddenly, the stop lights automatically flash to alert the vehicle behind

When the TRC/VSC/ABS systems are operating

The slip indicator light will flash while the TRC/VSC/ABS systems are operating.

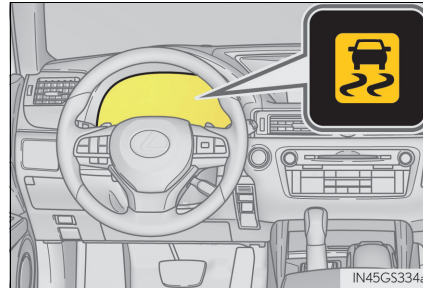

Disabling the TRC system

If the vehicle gets stuck in mud, dirt or snow, the TRC system may reduce power from the hybrid system to the wheels. Pressing  to turn the system off may make it easier to rock the vehicle in order to free it.

To turn the TRC system off, quickly press and release .

The "Traction Control Turned Off" will be shown on the multi-information display.

Press  again to turn the system back on.



■ Turning off both TRC and VSC systems

To turn the TRC and VSC systems off, press and hold  for more than 3 seconds while the vehicle is stopped.

The VSC OFF indicator light will come on and the “Traction Control Turned Off” will be shown on the multi-information display.*

Press  again to turn the systems back on.

*: On vehicles with PCS (Pre-Crash Safety system), pre-crash brake assist and pre-crash braking will also be disabled. The PCS (Pre-Crash Safety system) warning light will come on and a message will be displayed on the multi-information display. (→P. 466)

■ When the message is displayed on the multi-information display showing that TRC has been disabled even if  has not been pressed

TRC and hill-start assist control cannot be operated. Contact any authorized Lexus retailer or Lexus authorized repairer, or any reliable repairer.

■ VGRS is disabled when

VGRS may stop operating in the following situations.

In this event, the steering wheel may move from its straight forward position, but it will return when the system restarts.

- The steering wheel is operated for an extended period of time while the vehicle is stopped or is moving very slowly.
- When force is continuously applied for a long time with the steering wheel turned as far as it will go.

The center position of the steering wheel may change when VGRS is disabled. However, the position will return to normal after VGRS is reactivated.

■ When the 12-volt battery is disconnected

The steering wheel may move from its straight forward position, but this will be corrected automatically when driving.

■ Sounds and vibrations caused by the ABS, brake assist, VSC, Hill-start assist control, TRC and VGRS systems

Any of the following conditions may occur when the above systems are operating. None of these indicates that a malfunction has occurred.

- Vibrations may be felt through the vehicle body and steering.
- A motor sound may be heard after the vehicle comes to a stop.

■ ECB operation sound

ECB operating sound may be heard in the following cases, but it does not indicate that a malfunction has occurred.

- Operating sound heard from the engine compartment when the brake pedal is operated.
- Motor sounds of the brake system heard from the front part of the vehicle when the driver's door is opened.
- Operating sound heard from the engine compartment when one or two minutes passed after the stop of the hybrid system.

■ EPS, VGRS and DRS operation sound

When the steering wheel is operated, a motor sound (whirring sound) may be heard. This does not indicate a malfunction.

■ Automatic reactivation of TRC and VSC systems

After turning the TRC and VSC systems off, the systems will be automatically re-enabled in the following situations:

- When the power switch is turned off
- If only the TRC system is turned off, the TRC will turn on when vehicle speed increases
If both TRC and VSC systems are turned off, automatic re-enabling will not occur when vehicle speed increases.

■ Reduced effectiveness of the EPS system

The effectiveness of the EPS system is reduced to prevent the system from overheating when there is frequent steering input over an extended period of time. The steering wheel may feel heavy as a result. Should this occur, refrain from excessive steering input or stop the vehicle and turn the hybrid system off. The EPS system should return to normal within 10 minutes.

■ Operating conditions of hill-start assist control

When the following four conditions are met, the hill-start assist control will operate;

- The shift lever is in a position other than N or P (when starting off forward/backward on an upward incline).
- The vehicle is stopped.
- The accelerator pedal is not depressed.
- The parking brake is not engaged.

■ Automatic system cancelation of hill-start assist control

The hill-start assist control will be canceled in any of the following situations;

- The shift lever is shifted to N or P.
- The accelerator pedal is depressed.
- The parking brake is engaged.
- Approximately 2 seconds elapse after the brake pedal is released.

■ Operating conditions of emergency brake signal

When the following three conditions are met, the emergency brake signal will operate:

- The emergency flashers are off.
- Actual vehicle speed is over 55 km/h (35 mph).
- The brake pedal is depressed in a manner that cause the system to judge from the vehicle deceleration that this is a sudden braking operation.

■ Automatic system cancelation of emergency brake signal

The emergency brake signal will turn off in any of the following situations:

- The emergency flashers are turned on.
- The brake pedal is released.
- The system judges from the vehicle deceleration that is not a sudden braking operation.

WARNING

■ The ABS does not operate effectively when

- The limits of tire gripping performance have been exceeded (such as excessively worn tires on a snow covered road).
- The vehicle hydroplanes while driving at high speed on wet or slick roads.

■ Stopping distance when the ABS is operating may exceed that of normal conditions

The ABS is not designed to shorten the vehicle's stopping distance. Always maintain a safe distance from the vehicle in front of you, especially in the following situations:

- When driving on dirt, gravel or snow-covered roads
- When driving with tire chains
- When driving over bumps in the road
- When driving over roads with potholes or uneven surfaces

■ TRC may not operate effectively when

Directional control and power may not be achievable while driving on slippery road surfaces, even if the TRC system is operating.

Drive the vehicle carefully in conditions where stability and power may be lost.

■ Hill-start assist control does not operate effectively when

- Do not overly rely on the hill-start assist control. The hill-start assist control may not operate effectively on steep inclines and roads covered with ice.
- Unlike the parking brake, hill-start assist control is not intended to hold the vehicle stationary for an extended period of time. Do not attempt to use hill-start assist control to hold the vehicle on an incline, as doing so may lead to an accident.

 **WARNING**

■ **When the VSC is activated**

The slip indicator light flashes. Always drive carefully. Reckless driving may cause an accident. Exercise particular care when the indicator light flashes.

■ **When the TRC/VSC systems are turned off**

Be especially careful and drive at a speed appropriate to the road conditions. As these are the systems to help ensure vehicle stability and driving force, do not turn the TRC/VSC systems off unless necessary.

■ **Replacing tires**

Make sure that all tires are of the specified size, brand, tread pattern and total load capacity. In addition, make sure that the tires are inflated to the recommended tire inflation pressure level.

The ABS, TRC and VSC systems will not function correctly if different tires are installed on the vehicle.

Contact any authorized Lexus retailer or Lexus authorized repairer, or any reliable repairer for further information when replacing tires or wheels.

■ **Handling of tires and the suspension**

Using tires with any kind of problem or modifying the suspension will affect the driving assist systems, and may cause a system to malfunction.

Hybrid vehicle driving tips

For economical and ecological driving, pay attention to the following points:

◆ Using Eco drive mode

When using Eco drive mode, the torque corresponding to the accelerator pedal depression amount can be generated more smoothly than it is in normal conditions. In addition, the operation of the air conditioning system (heating/cooling) will be minimized, improving the fuel economy. (→P. 311)

◆ Use of Hybrid System Indicator

The Eco-friendly driving is possible by keeping the indicate of Hybrid System Indicator within Eco area. (→P. 108, 123)

◆ Shift lever operation

Shift the shift lever to D when stopped at a traffic light, or driving in heavy traffic etc. Shift the shift lever to P when parking. When using the N, there is no positive effect on fuel consumption. In the N, the gasoline engine operates but electricity cannot be generated. Also, when using the air conditioning system, etc., the hybrid battery (traction battery) power is consumed.

◆ Accelerator pedal/brake pedal operation

- Drive your vehicle smoothly. Avoid abrupt acceleration and deceleration. Gradual acceleration and deceleration will make more effective use of the electric motor (traction motor) without having to use gasoline engine power.
- Avoid repeated acceleration. Repeated acceleration consumes hybrid battery (traction battery) power, resulting in poor fuel consumption. Battery power can be restored by driving with the accelerator pedal slightly released.

◆ When braking

Make sure to operate the brakes gently and in a timely manner. A greater amount of electrical energy can be regenerated when slowing down.

◆ Delays

Repeated acceleration and deceleration, as well as long waits at traffic lights, will lead to bad fuel economy. Check traffic reports before leaving and avoid delays as much as possible. When driving in a traffic jam, gently release the brake pedal to allow the vehicle to move forward slightly while avoiding overuse of the accelerator pedal. Doing so can help control excessive gasoline consumption.

◆ Highway driving

Control and maintain the vehicle at a constant speed. Before stopping at a toll booth or similar, allow plenty of time to release the accelerator and gently apply the brakes. A greater amount of electrical energy can be regenerated when slowing down.

◆ Air conditioning

Use the air conditioning only when necessary. Doing so can help reduce excessive gasoline consumption.

In summer: When the ambient temperature is high, use the recirculated air mode. Doing so will help to reduce the burden on the air conditioning system and reduce fuel consumption as well.

In winter: Because the gasoline engine will not automatically cut out until it and the interior of the vehicle are warm, it will consume fuel. Also, fuel consumption can be improved by avoiding overuse of the heater.

◆ Checking tire inflation pressure

Make sure to check the tire inflation pressure frequently. Improper tire inflation pressure can cause poor fuel economy.

Also, as snow tires can cause large amounts of friction, their use on dry roads can lead to poor fuel economy. Use tires that are appropriate for the season.

◆ Luggage

Carrying heavy luggage will lead to poor fuel economy. Avoid carrying unnecessary luggage. Installing a large roof rack will also cause poor fuel economy.

◆ Warming up before driving

Since the gasoline engine starts up and cuts out automatically when cold, warming up the engine is unnecessary. Moreover, frequently driving short distances will cause the engine to repeatedly warm up, which can lead to excess fuel consumption.

Winter driving tips

Carry out the necessary preparations and inspections before driving the vehicle in winter. Always drive the vehicle in a manner appropriate to the prevailing weather conditions.

Preparation for winter

- Use fluids that are appropriate to the prevailing outside temperatures.
 - Engine oil
 - Engine/power control unit coolant
 - Washer fluid
- Have a service technician inspect the condition of the 12-volt battery.
- Have the vehicle fitted with four snow tires or purchase a set of tire chains for the rear tires.*

Ensure that all tires are the specified size and brand, and that chains match the size of the tires.

*: Tire chains cannot be mounted on vehicles with front and rear tires of differing sizes and vehicles with LDH and 19 inch tires

Before driving the vehicle

Perform the following according to the driving conditions:

- Do not try to forcibly open a window or move a wiper that is frozen. Pour warm water over the frozen area to melt the ice. Wipe away the water immediately to prevent it from freezing.
- To ensure proper operation of the climate control system fan, remove any snow that has accumulated on the air inlet vents in front of the windshield.
- Check for and remove any excess ice or snow that may have accumulated on the exterior lights, vehicle's roof, chassis, around the tires or on the brakes.
- Remove any snow or mud from the bottom of your shoes before getting in the vehicle.

When driving the vehicle

Accelerate the vehicle slowly, keep a safe distance between you and the vehicle ahead, and drive at a reduced speed suitable to road conditions.

When parking the vehicle

- Park the vehicle and move the shift lever to P without setting the parking brake. The parking brake may freeze up, preventing it from being released. If the vehicle is parked without setting the parking brake, make sure to block the wheels.

Failure to do so may be dangerous because it may cause the vehicle to move unexpectedly, possibly leading to an accident.

- If the vehicle is parked without setting the parking brake, confirm that the shift lever cannot be moved out of P*.

*: The shift lever will be locked if it is attempted to be shifted from P to any other position without depressing the brake pedal. If the shift lever can be shifted from P, there may be a problem with the shift lock system. Have the vehicle inspected by any authorized Lexus retailer or Lexus authorized repairer, or any reliable repairer immediately.

Selecting tire chains

- ▶ Vehicles with front and rear tires of the same size except for the vehicles with LDH and 19 inch tires

Use the correct tire chain size when mounting the tire chains.

Chain size is regulated for each tire size.

- ① Side chain
(3 mm [0.12 in.] in diameter)
- ② Cross chain
(4 mm [0.16 in.] in diameter)

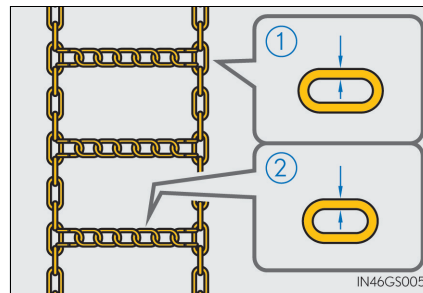

- ▶ Vehicles with front and rear tires of differing sizes and vehicles with LDH and 19 inch tires

Tire chains cannot be mounted.

Snow tires should be used instead.

Regulations on the use of tire chains

Regulations regarding the use of tire chains vary depending on location and type of road. Always check local regulations before installing chains.

Shifting the windshield wiper position

If heavy snow or icy condition is expected, shift the rest position manually.

Grip the hook section of the wiper arm firmly when shifting the wiper position.

■ To rest position

Raise the wiper in line with the windshield.

You can stand the wipers up for the rest position.

★: More than 10 cm (3.9 in.)

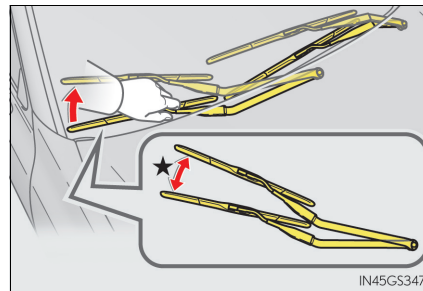

■ To retract position

Lower the wipers by pressing on the upper part of the hook section.

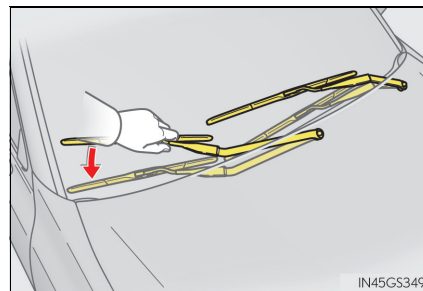

■ Tire chain installation

Observe the following precautions when installing and removing chains:

- Install and remove tire chains in a safe location.
- Install tire chains on the rear tires. Do not install tire chains on the front tires.
- Install tire chains on rear tires as tightly as possible. Retighten chains after driving 0.5 — 1.0 km (1/4 — 1/2 mile).
- Install tire chains following the instructions provided with the tire chains.

 **WARNING****■ Driving with snow tires**

Observe the following precautions to reduce the risk of accidents. Failure to do so may result in a loss of vehicle control and cause death or serious injury.

- Use tires of the specified size.
- Maintain the recommended level of air pressure.
- Do not drive at speeds in excess of the speed limit or the speed limit specified for the snow tires being used.
- Use snow tires on all, not just some wheels.

■ Driving with tire chains (vehicles with front and rear tires of the same size except for the vehicles with LDH and 19 inch tires)

Observe the following precautions to reduce the risk of accidents. Failure to do so may result in the vehicle being unable to be driven safely, and may cause death or serious injury.

- Do not drive in excess of the speed limit specified for the tire chains being used, or 50 km/h (30 mph), whichever is lower.
- Avoid driving on bumpy road surfaces or over potholes.
- Avoid sudden acceleration, abrupt steering, sudden braking and shifting operations that cause sudden engine braking.
- Slow down sufficiently before entering a curve to ensure that vehicle control is maintained.
- Do not use LKA (Lane-Keeping Assist) system. (if equipped)

 **NOTICE****■ Repairing or replacing snow tires**

Request repairs or replacement of snow tires from Lexus dealers or legitimate tire retailers.

This is because the removal and attachment of snow tires affects the operation of the tire pressure warning valves and transmitters.

■ Fitting tire chains (vehicles with front and rear tires of the same size except for the vehicles with LDH and 19 inch tires)

The tire pressure warning valves and transmitters may not function correctly when tire chains are fitted.

■ When standing the windshield wipers up

Raise the wipers in line with the windshield. (→P. 337)

Failure to do so may result in damage to the wipers and/or the hood.

Interior features

5

- 5-1. Remote Touch screen**
 Remote Touch/12.3-inch display 340
- 5-2. Using the air conditioning system and defogger**
 Front automatic air conditioning system 346
 Rear air conditioning system 358
 Heated steering wheel/ seat heaters/ seat ventilators 361
- 5-3. Using the interior lights**
 Interior lights list 366
 • Interior lights 367
 • Personal lights 367
- 5-4. Using the storage features**
 List of storage features 369
 • Glove box 370
 • Console box 370
 • Cup holders 371
 • Auxiliary boxes 373
 Trunk features 374
- 5-5. Using the other interior features**
 Other interior features 377
 • Sun visors 377
 • Vanity mirrors 377
 • Clock 378
 • Ashtrays 378
 • Power outlets 379
 • Armrest 380
 • Rear sunshade/ rear door sunshades 380
 • Coat hooks 382
 • Assist grips 383
 ERA-GLONASS 384

Remote Touch/12.3-inch display*

The Remote Touch can be used to operate the Remote Touch screens. Owners of models equipped with a navigation system should refer to the “NAVIGATION AND MULTIMEDIA SYSTEM OWNER’S MANUAL”.

The illustration below is for left-hand drive vehicles. The button positions may differ slightly for right-hand drive vehicles.

Remote Touch operation

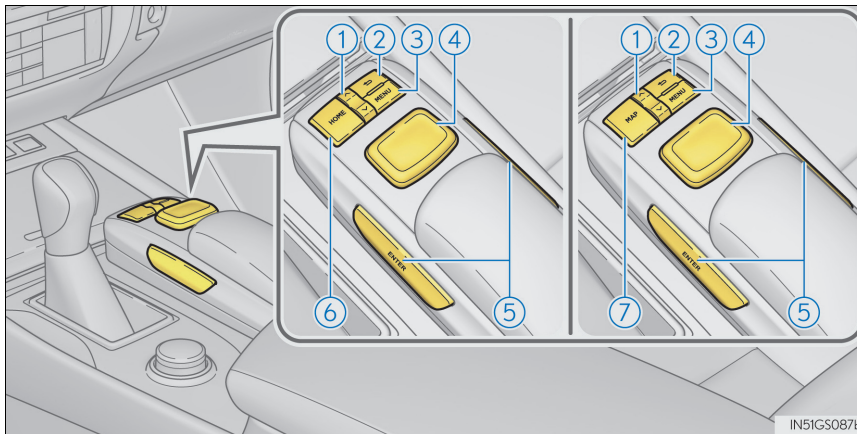

*: If equipped

- ① “^•v” button
Press this button to change map scale and scroll through lists.
- ② Back button
Press this button to display the previous screen.
- ③ “MENU” button
Press this button to display the “Menu” screen.
- ④ Remote Touch knob
Move in the desired direction to select a function, letter and screen button.
Press the knob to enter the selected function, letter or screen button.
- ⑤ “ENTER” buttons
Press this button to enter the selected function, letter or screen button.
- ⑥ “HOME” button (vehicles with 8-inch display)
Press this button to display the home screen.
- ⑦ “MAP” button (vehicles with 12.3-inch display)
Press this button to display the vehicle’s current position.

■ Using the Remote Touch knob

- ① Select: Move the knob in the desired direction.
- ② Enter: Press the knob or “ENTER” button.

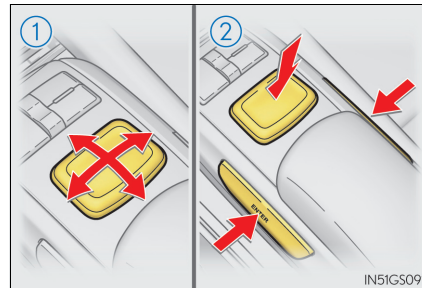

■ **Screen display during low temperatures**

When the ambient temperature is extremely low, screen response may be delayed even if the Remote Touch is operated.

 **WARNING**

■ **When using the Remote Touch**

- Do not allow fingers, fingernails or hair to become caught in the Remote Touch as this may cause an injury.
- Be careful when selecting the Remote Touch in extreme temperatures as it may become very hot or cold due to the temperature inside the vehicle.

 **NOTICE**

■ **To prevent damage to the Remote Touch**

- Do not allow the Remote Touch to come into contact with food, liquid, stickers or lit cigarettes as doing so may cause it to change color, emit a strange odor or stop functioning.
- Do not subject the Remote Touch to excessive pressure or strong impact as the knob may bend or break off.
- Do not allow coins, contact lenses or other such items to become caught in the Remote Touch as this may cause it to stop functioning.
- Items of clothing may rip if they become caught on the Remote Touch knob.
- If your hand or any object is on the Remote Touch knob when the power switch is turned to ACCESSORY mode, the Remote Touch knob may not operate properly.

“Menu” screen

Press the “MENU” button on the Remote Touch to display the “Menu” screen.

The display may differ depending on the type of the system.

12.3-inch display: When an interruption screen is being displayed on the side display, the “Menu” screen will be shown on the main display.

▶ Vehicles with 8-inch display



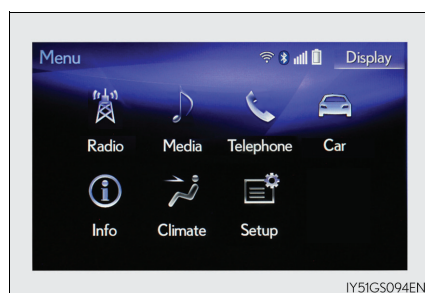



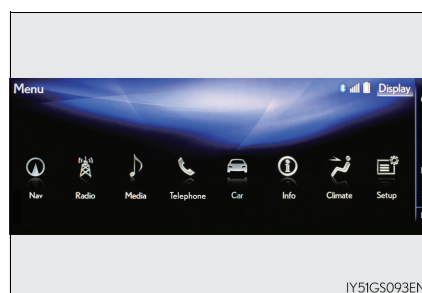

▶ Vehicles with 12.3-inch display



IY5IGS094EN



IY5IGS093EN

Switch	Function
	Select to display the map screen or the navigation menu screen. *1, 2
	Select to display the radio control screen. *1
	Select to operate the media control screen. *1
	Select to display the hands-free operation screen. *1
	Select to display the fuel consumption screen. (→P. 126, 129)
	Select to display the “Information” screen. *1
	Select to display the air conditioning control screen. (→P. 346)
	Select to display the “Setup” screen. *1

Switch	Function
"Display"	Select to adjust the contrast and brightness of the screens, turn the screen off, etc.*1

*1: Refer to the "NAVIGATION AND MULTIMEDIA SYSTEM OWNER'S MANUAL".

*2: If equipped

12.3-inch display operation

■ Full screen display

The following functions can be displayed full screen:

- Initial screen*
- "Menu" screen (→P. 343)
- Map screen*
- Audio screen*
- Energy monitor/fuel consumption screen (→P. 126)
- Air conditioning control screen (→P. 346)

*: Refer to the "NAVIGATION AND MULTIMEDIA SYSTEM OWNER'S MANUAL".

■ Split-screen display

Different information can be displayed on the left and right of the screen. For example, air conditioning system screen can be displayed and operated while the fuel consumption information screen is being displayed. The large screen on the left of the display is called the main display, and the small screen to the right is called the side display.



12.3-inch display function

For details of the functions and operation of the main display, refer to the respective section.

■ Display the side display

▶ Basic screens

The following functions can be displayed and operated on the side display.

Select the desired button.

- ① Navigation system*
- ② Audio*
- ③ Phone*
- ④ Vehicle information (→P. 131)
- ⑤ Air conditioning system (→P. 350)
- ⑥ Hide the side display.*



If the item displayed on the main display is full screen display compatible (→P. 344), it will be displayed full screen.

▶ Interruption screens

Each of the following screens is displayed automatically in accordance with conditions.

- Lexus parking assist-sensor* (if equipped)
- Phone*
- Driving mode (→P. 311)

*: Refer to the "NAVIGATION AND MULTIMEDIA SYSTEM OWNER'S MANUAL".

Front automatic air conditioning system

Air outlets and fan speed are automatically adjusted according to the temperature setting.

Press the "MENU" button on the Remote Touch, then select  to display the air conditioning operation screen.

Vehicles with 12.3-inch display: The air conditioning system can be displayed and operated on the side display. (→P. 344)

The illustrations below are for left-hand drive vehicles.

The button positions and shapes will differ for right-hand drive vehicles.

Also, the display and button positions will differ depending on the type of the system.

Control panel

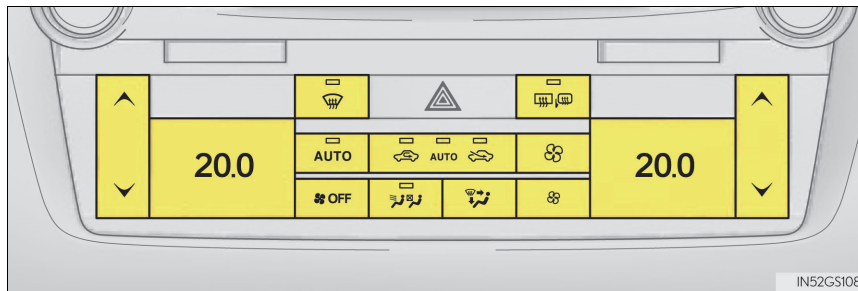

■ Adjusting the temperature setting

Press “^” on  to increase the temperature and “v” to decrease the temperature.

▶ Without rear air conditioning system



When “DUAL” on the control screen is selected or the passenger’s side temperature control button is pressed, the temperature for the driver and passenger seats can be adjusted separately.

▶ With rear air conditioning system

When “3-ZONE” on the control screen is selected or the passenger’s side temperature control button is pressed, the temperature for the driver’s, front passenger’s and rear seats (→P. 358) can be adjusted separately.

The air conditioning system switches between individual and simultaneous modes each time 3-ZONE is selected.

■ Adjusting the fan speed setting

Press  to increase the fan speed and  to decrease the fan speed.

Press the “OFF” button to turn the fan off.

■ Change the airflow mode

To change the air outlets, press .

The air outlets used are switched each time the button is pressed. (→P. 348)

■ S-FLOW mode

Press .

When  is pressed, the airflow changes as follows.

Without rear air conditioning system: Air flows to the front seats only.*

With rear air conditioning system: Air flows to the front seats only, and if the passenger seat is unoccupied, the set temperature, outside humidity and temperature inside the cabin are assessed, and air flows to the driver seat only.*

*: Air may also flow to the rear seats depending on the situation.

■ Other functions

- Switching between outside air and recirculated air modes (→P. 351)
- Defogging the windshield (→P. 352)
- Defogging the rear window and outside rear view mirrors (→P. 352)

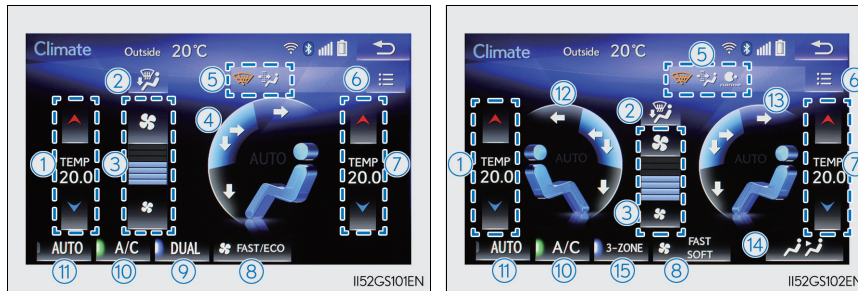

Control screen

- ▶ Without rear air conditioning system ▶ With rear air conditioning system



- ① Adjust the left-hand side temperature setting
- ② Select the air flow to the feet and operate the windshield defogger
- ③ Adjust the fan speed setting
- ④ Select the air flow mode* (the front seats)
- ⑤ Function on/off indicators on the option control screen
- ⑥ Display the option control screen (→P. 349)
- ⑦ Adjust the right-hand side temperature setting
- ⑧ Fan speed mode selector for automatic mode
- ⑨ Adjust the temperature for the driver's and front passenger's seats separately (DUAL mode) (→P. 347)
- ⑩ Set cooling and dehumidification function on/off
- ⑪ Select to set automatic mode on/off
- ⑫ Select the air flow mode* (the left-hand side)
- ⑬ Select the air flow mode* (the right-hand side)
- ⑭ Display the rear air conditioning operation screen (→P. 350)
- ⑮ Adjust the temperature for the driver's, front passenger's and rear seats (→P. 358) separately (3-ZONE mode) (→P. 347)

To adjust or select settings, move the Remote Touch knob to select the screen button, and then press the Remote Touch knob or the "ENTER" button of Remote Touch to enter the selected function.

- *:  — Air flows to the upper body
-  — Air flows to the upper body and feet
-  — Air flows to the feet

■ Option control screen

Select  on the control screen to display the option control screen. The functions can be switched on and off.

When the function is on, the indicator illuminates on the control screen.
(→P. 348)

- ① Prevent ice from building up on the windshield and wiper blades (if equipped) (→P. 352)
- ② Remove pollen from the air (Pollen removal mode) (→P. 352)
- ③ nanoe™* system on/off (if equipped) (→P. 356)

*: nanoe™ and the nanoe™ mark are trademarks of Panasonic Corporation.

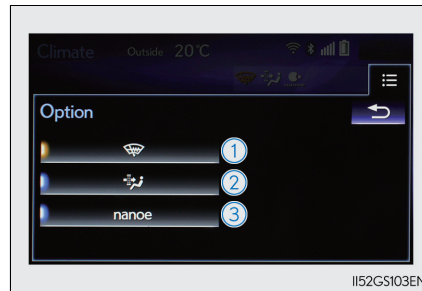

■ Side display (vehicles with 12.3-inch display)

- ▶ Without rear air conditioning system
- ▶ With rear air conditioning system

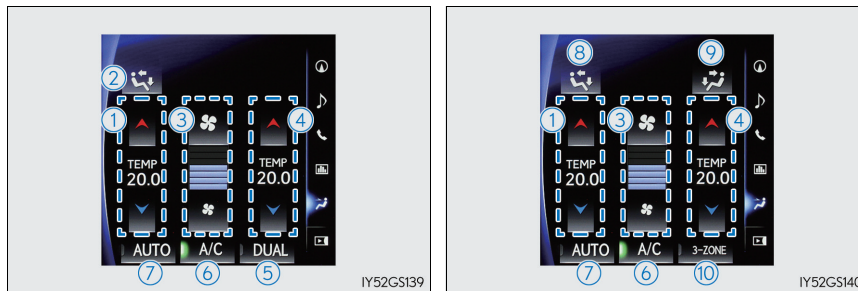

- ① Adjust the left-hand side temperature setting
- ② Select the air flow mode (the front seats)
- ③ Adjust the fan speed setting
- ④ Adjust the right-hand side temperature setting
- ⑤ Adjust the temperature for the driver's and front passenger's seats separately (DUAL mode) (→P. 347)
- ⑥ Set cooling and dehumidification function on/off
- ⑦ Select to set automatic mode on/off
- ⑧ Select the air flow mode (the left-hand side)
- ⑨ Select the air flow mode (the right-hand side)
- ⑩ Adjust the temperature for the driver's, front passenger's and rear seats (→P. 358) separately (3-ZONE mode) (→P. 347)

■ Rear air conditioning control screen (with rear air conditioning system)

- ① Adjust the rear seat temperature setting
- ② Disabling the switches on the rear armrest
- ③ Turn the fan off (rear seat)
- ④ Select to set automatic mode on/off (rear seat)

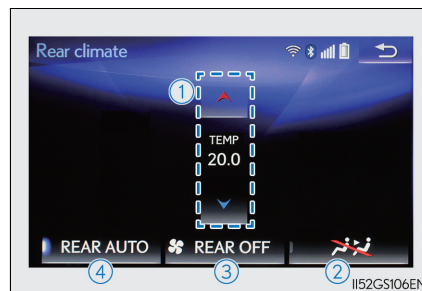

Air conditioning control

■ Using the automatic mode

- 1 Press  or select "AUTO" on the control screen.

Also, when selecting "FAST/ECO" or  each time, the fan speed mode will be changed as follows:

"NORMAL" → "ECO" → "FAST"

- 2 Press  to switch to automatic air intake mode.

The air conditioning system automatically switches between outside air and recirculated air modes.

- 3 Adjust the temperature setting. (→P. 347)

To stop the operation, press the "OFF" button.

Air outlets and fan speed for the driver and passenger seats may be adjusted separately depending on the temperature setting.

When the front seat heaters and ventilators/rear seat heaters are set to AUTO mode, the system is operated automatically according to the set temperature, outside temperature, etc.



■ Automatic mode indicator

If the fan speed setting or air flow modes are operated, the automatic mode indicator goes off. However, automatic mode for functions other than that operated is maintained.

Other functions

■ Switching between outside air and recirculated air modes

Press .

The mode switches among  (recirculated air mode), automatic and  (outside air mode) modes each time the button is pressed.

When the system is switched to automatic mode, the air conditioning system operates automatically.

■ **Defogging the windshield**

Defoggers are used to defog the windshield and front side windows.

Press .

Set the outside/recirculated air mode button to outside air mode if the recirculated air mode is used. (It may switch automatically.)

To defog the windshield and the side windows early, turn the air flow and temperature up.

To return to the previous mode, press  again when the windshield is defogged.

■ **Defogging the rear window and outside rear view mirrors**

Defoggers are used to defog the rear window and to remove raindrops, dew and frost from the outside rear view mirrors.

Press .

The defoggers will automatically turn off after 15 to 60 minutes. The operation time changes according to the ambient temperature and vehicle speed.

■ **Windshield wiper de-icer (if equipped)**

This feature is used to prevent ice from building up on the windshield and wiper blades.

Select  on the option control screen.

The windshield wiper de-icer will automatically turn off after approximately 15 minutes

■ **Pollen removal mode**

Pollen is removed from the air and the air flows to the upper part of the body.

Select  on the option control screen.

Usually the system will turn off automatically.

In order to prevent the windshield from fogging up when the outside air is cold, the dehumidification function may operate.

The pollens are filtered out even if the pollen removal mode is turned off.

Changing the rear seat settings (with rear air conditioning system)

Select  on the control screen to display the rear air conditioning control screen.

■ Using the automatic mode

- 1 Select "REAR AUTO" on the screen.



The air conditioning system will operate, and air outlets and speed will be set automatically.

When the rear seat heaters are set to automatic mode, the system is operated automatically according to the set temperature, outside temperature, etc.

- 2 Adjust the temperature setting.

To stop the operation, select "REAR OFF".

■ Adjusting the temperature setting

Select  to increase the temperature and  to decrease the temperature.

The air conditioning system switches between individual and simultaneous modes each time "3-ZONE" on the control screen is selected.

■ Disabling the switches on the rear armrest.

Select .

Rear seat heater switches (→P. 362) are also locked.

Air outlets

■ Location of air outlets

The air outlets and air volume changes according to the selected air flow mode.

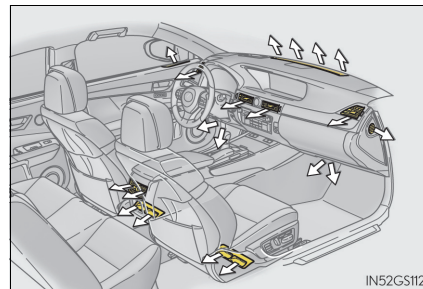

■ **Adjusting the position of and opening and closing the air outlets**

- ▶ Front center outlets and front side outlets
- ▶ Rear seat outlets

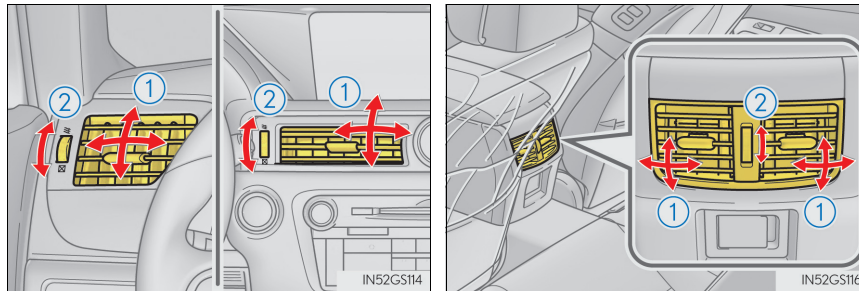

- ① Direct air flow to the left or right, up or down.
- ② Turn the knob to open or close the vent.

■ **Registering air conditioning settings to electronic keys**

- Unlocking the vehicle using an electronic key and turning the power switch to ON mode will recall that key's registered air conditioning settings.
- When the power switch is turned off, the current air conditioning settings will automatically be registered to the electronic key that was used to unlock the vehicle.
- The system may not operate correctly if more than one electronic key is in the vicinity or if the smart entry & start system is used to unlock a passenger door.
- Settings for the electronic key and the corresponding door can be changed. Contact any authorized Lexus retailer or Lexus authorized repairer, or any reliable repairer.

■ **Using automatic mode**

Fan speed is adjusted automatically according to the temperature setting and the ambient conditions.

Therefore, the fan may stop for a while until warm or cool air is ready to flow immediately after  is pressed.

Cool air may blow around the upper body even when the heater is on due to sunlight.

■ **Fogging up of the windows**

- The windows will easily fog up when the humidity in the vehicle is high. Turning "A/C" on will dehumidify the air from the outlets and defog the windshield effectively.
- If you turn "A/C" off, the windows may fog up more easily.
- The windows may fog up if the recirculated air mode is used.

■ Outside/recirculated air mode

- When driving on dusty roads such as tunnels or in heavy traffic, set the outside/recirculated air mode button to the recirculated air mode. This is effective in preventing outside air from entering the vehicle interior. During cooling operation, setting the recirculated air mode will also cool the vehicle interior effectively.
- Outside/recirculated air mode may automatically switch depending on the temperature setting or the inside temperature.

■ Automatic mode for air intake control

In automatic mode, the system detects exhaust gas and other pollutants and automatically switches between outside air and recirculated air modes.

When the dehumidification function is off, and the fan is operating, turning automatic mode on will activate the dehumidification function.

■ Operation of the air conditioning system in Eco drive mode

In the Eco drive mode, the air conditioning system is controlled as follows to prioritize fuel efficiency:

- Engine speed and compressor operation controlled to restrict heating/cooling capacity
- Fan speed restricted when automatic mode is selected
 - To improve air conditioning performance, perform the following operations:
- Adjust the fan speed
- Turn off Eco drive mode (→P. 311)

■ When the S-FLOW mode operates

If air flows to the driver's seat only, the temperature setting for the front passenger's seat is not displayed.

■ When the outside temperature is low

The dehumidification function may not operate even when "A/C" on the option control screen is selected.

■ Ventilation and air conditioning odors

- To let fresh air in, set the air conditioning system to the outside air mode.
- During use, various odors from inside and outside the vehicle may enter into and accumulate in the air conditioning system. This may then cause odor to be emitted from the vents.
- To reduce potential odors from occurring:
 - It is recommended that the air conditioning system be set to outside air mode prior to turning the vehicle off.
 - The start timing of the blower may be delayed for a short period of time immediately after the air conditioning system is started in automatic mode.



■ **nanoe™^{*1} system (if equipped)**

Your vehicle incorporates a nanoe™ device, which is considered a biocidal product. The nanoe™ device generates charged water particles from the ambient air and these purify the air in the cabin by suppressing bacteria.

The nanoe™ device is considered a biocidal product in the EU according to the interpretation of Regulation (EU) No 528/2012.

Active substances: Charged water particles (nano) containing hydroxyl radicals, generated from ambient air

nanoe™ helps to provide purified air by emitting electrically charged water particles through the front center vent on the driver's side*2.

- When the fan is turned on and "nanoe" on the option control screen is selected, the nanoe™ system is activated.
- When the fan is operated in the following conditions, system performance will be maximized. If the following conditions are not met, performance will be limited.
 - The ,  or  air outlets are being used.
 - The front center vent on driver's side is open.
- When nanoe™ is generated, a small amount of ozone is emitted and may be faintly smelled in some situations. However, this is approximately the same as the amount that already exists in nature, such as in forests, and it has no affect on the human body.
- A slight noise may be heard during operation. This is not a malfunction.

*1: nanoe™ and the nanoe™ mark are trademarks of Panasonic Corporation.

*2: According to temperature and humidity conditions, fan speed and direction of the air flow, the nanoe™ system may not operate at full capacity.

■ **Air conditioning filter**

→P. 433

■ **Customization**

Settings (e.g. exhaust gas sensor sensitivity) can be changed.
(Customizable features: →P. 561)

 **WARNING**

■ **To prevent the windshield from fogging up**

- Do not use  during cool air operation in extremely humid weather. The difference between the temperature of the outside air and that of the windshield can cause the outer surface of the windshield to fog up, blocking your vision.
- Do not place anything on the instrument panel which may cover the air outlets. Otherwise, air flow may be obstructed, preventing the windshield defoggers from defogging.

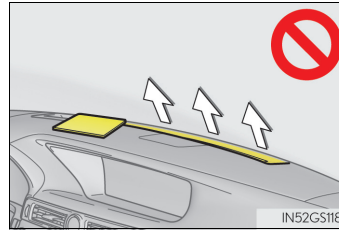

■ **To prevent burns**

- Do not touch the rear view mirror surfaces when the outside rear view mirror defoggers are on.
- Vehicles with windshield wiper de-icer: Do not touch the glass at lower part of the windshield or to the side of the front pillars when the windshield wiper de-icer is on.

■ **nanoe™ generator (if equipped)**

Do not disassemble or repair the generator because it contains high voltage parts. Contact any authorized Lexus retailer or Lexus authorized repairer, or any reliable repairer if the generator needs repair.

 **NOTICE**

■ **To prevent 12-volt battery discharge**

Do not leave the air conditioning system on longer than necessary when the hybrid system is off.

■ **To prevent damage to the nanoe™ (if equipped)**

Do not insert anything into the driver's side vent, attach anything to it, or use sprays around the driver's side vent. These things may cause the generator not to work properly.

Rear air conditioning system*

Air outlets and fan speed are automatically adjusted according to the temperature setting.

Control panel

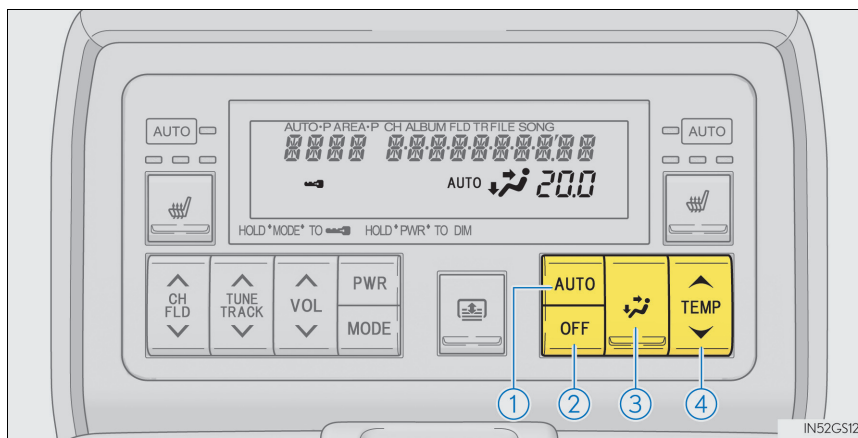

- ① Set automatic mode on/off
- ② Turn the fan off
- ③ Change the airflow mode
- ④ Adjust the temperature setting

■ Adjusting the temperature setting

Press “^” on **TEMP** to increase the temperature and “v” to decrease the temperature.

*: If equipped

■ Changing the air outlets

Press .

The air outlets change as follows each time  is pressed.

 : Air flows to the upper body.

 : Air flows to the upper body and feet.

 : Air flows to the feet.

Using automatic air conditioning system

- 1 Press **AUTO**.

The air conditioning system will operate, and air outlets and fan speed will be adjusted automatically.

“AUTO” will be displayed on the control panel.

- 2 Adjust the temperature setting.

When the rear seat heaters are set to “AUTO” mode, the system is operated automatically according to the set temperature, outside temperature, etc.

To stop the operation, press the “OFF” button.

Air outlets

■ Location of air outlets

The air outlets and air volume changes according to the selected air flow mode.

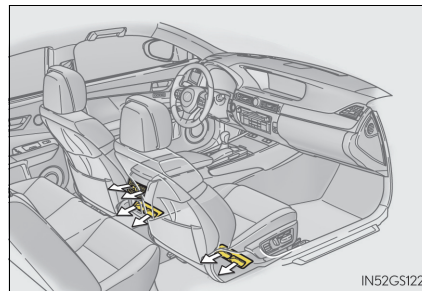

■ **Adjusting the position of and opening and closing the air outlets**

- ① Direct air flow to the left or right, up or down.
- ② Turn the knob to open or close the vent.

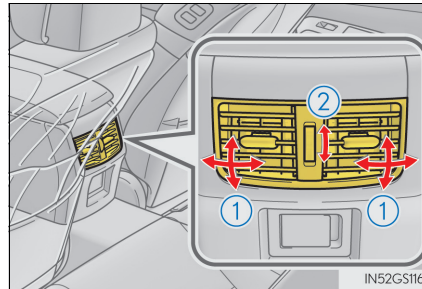

■ **Button lock function**

To prevent inadvertent operation, the buttons on the rear armrest can be locked. Press **MODE** until you hear a beep to lock the buttons. Pressing **MODE** again until you hear a beep will release the lock.

The indicator appears on the display when the buttons are locked.

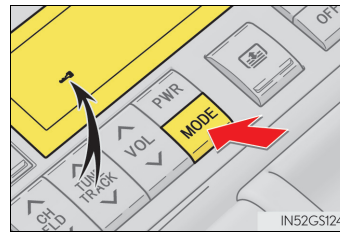

■ **Rear control panel illumination off function**

Control panel illumination on the rear armrest can be turned off. Press **PWR** until you hear a beep to turn the illumination off. Pressing **PWR** again until you hear a beep will turn the illumination on.

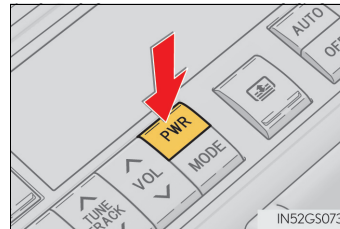

 **NOTICE**

■ **To prevent 12-volt battery discharge**

Do not leave the air conditioning system on longer than necessary when the hybrid system is off.

Heated steering wheel* /seat heaters* /seat ventilators*

Heated steering wheel and seat heaters heat the side grips of the steering wheel and seats, respectively. Seat ventilators maintain good airflow by blowing air from the seats.

⚠ WARNING

- Care should be taken to prevent injury if anyone in the following categories comes in contact with the steering wheel and seats when the heater is on:
 - Babies, small children, the elderly, the sick and the physically challenged
 - Persons with sensitive skin
 - Persons who are fatigued
 - Persons who have taken alcohol or drugs that induce sleep (sleeping drugs, cold remedies, etc.)
- Observe the following precautions to prevent minor burns or overheating:
 - Do not cover the seat with a blanket or cushion when using the seat heater.
 - Do not use seat heater more than necessary.

⚠ NOTICE

- To prevent damage to the seat heaters/seat ventilators, do not put heavy objects that have an uneven surface on the seat and do not stick sharp objects (needles, nails, etc.) into the seat.
- To prevent 12-volt battery discharge, do not use the functions when the hybrid system is off.

*: If equipped

Heated steering wheel (if equipped)

Turns the heated steering wheel on/off
The indicator light comes on when the heater is operating.

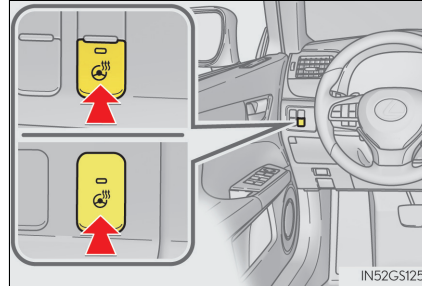

- The heated steering wheel can be used when the power switch is in ON mode.
- The heated steering wheel will automatically turn off after about 30 minutes.

Seat heaters/seat ventilators

■ Front seat heaters and ventilators (if equipped)/rear seat heaters (if equipped)

► Front seats

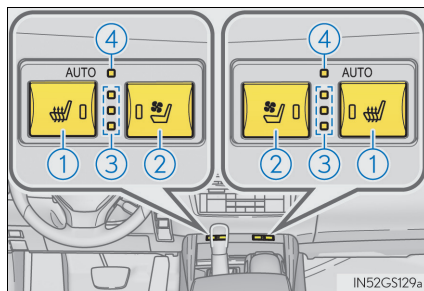

► Rear seats

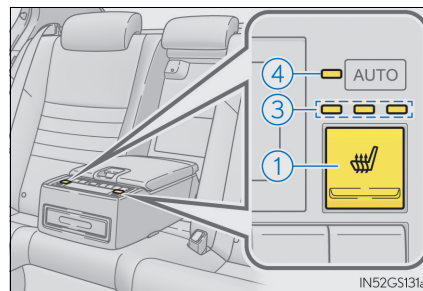

- ① Seat heater switches
The indicator light (yellow) on the switch comes on when the seat heater is operating.
- ② Seat ventilator switches (front seats only)
The indicator light (green) on the switch comes on when the seat ventilator is operating.
- ③ Level indicator lights
The seat heater temperature level or the seat ventilator fan speed level (for front seats only) is displayed.
- ④ "AUTO" indicator lights

● Modes and indicators

The mode can be changed by pressing the switch.

Mode	"AUTO" indicator light	Level indicator lights
Off	Off	Off
Automatic*	On	3 to 1, or off
Hi	Off	3
Mid	Off	2
Lo	Off	1

*: When automatic mode is selected, the level automatically changes depending on the air conditioning settings.

■ Seat heaters (without seat ventilators) (if equipped)

- ① Seat heater switches
- ② Level indicator lights

The seat heater temperature level is displayed.

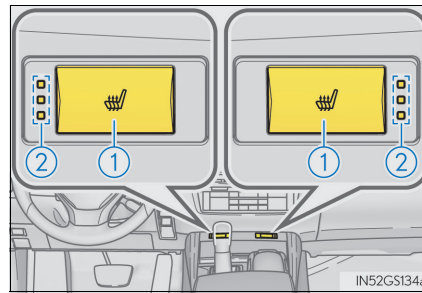

● Modes and indicators

The mode changes each time the switch is pressed as follows:

Mode	Level indicator lights	Automatic operation*
Off	Off	—
Hi	3	Hi → Mid → Lo
Mid	2	Mid → Lo
Lo	1	Lo

*: The mode changes automatically depending on the amount of time that has elapsed. The amount of time until the mode changes varies depending on the interior temperature when the seat heater was operated and other factors.

■ **Seat ventilators (without seat heaters) (if equipped)**

- ① Seat ventilator switches
 - ② Level indicator lights
- The seat ventilator fan speed level is displayed.

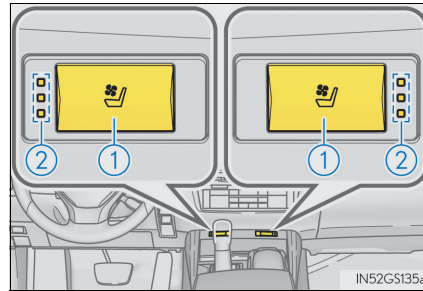

● **Modes and indicators**

The mode changes each time the switch is pressed as follows:

Mode	Level indicator lights
Off	Off
Hi	3
Mid	2
Lo	1

■ **The seat heaters/seat ventilators can be used when**

The power switch is in ON mode.

■ **Seat heater control (vehicles without automatic mode)**

The seat heater automatically changes operations. If the power switch is turned off while the seat heater is operating, the starting operation of the heater differs depending on the amount of time that elapses before it is turned back on.

Current operation	Starting operation mode and amount of time elapsed until power switch in ON mode	
	0 to 15 minutes	Over 15 minutes
Hi	Hi	Hi
Mid	Mid	Hi
Lo	Lo	Hi

■ **Automatic operation of the seat heater during Eco drive mode**

Eco drive mode controls the heating operations and fan speed of the air conditioning system to enhance fuel efficiency. If the driving mode select switch is switched to Eco drive mode in cold temperatures, the seat heater may be automatically operated to assist heating performance.

■ Automatic operation during S-FLOW mode

The front seat heater and ventilator or the rear seat heater may automatically turn off when S-FLOW mode is turned on during automatic mode. (→P. 347)

■ Button lock function (vehicles with rear control panel)

To prevent inadvertent operation, some buttons on the rear armrest can be locked. (→P. 360)

■ When the switch is disabled (vehicles with rear control panel)

When the rear control panel switch cannot be operated even though the button lock function is released, check whether the switch is disabled due to selecting  on Remote Touch screen. (→P. 353)

■ Rear control panel illumination off function (vehicles with rear control panel)

Control panel illumination on the rear armrest can be turned off. (→P. 360)

■ Customization

The automatic operation of the front seat heaters (without seat ventilators) and the automatic mode settings for the front seat heaters and ventilators or the rear seat heaters can be changed. (Customizable features: →P. 572)

Interior lights list

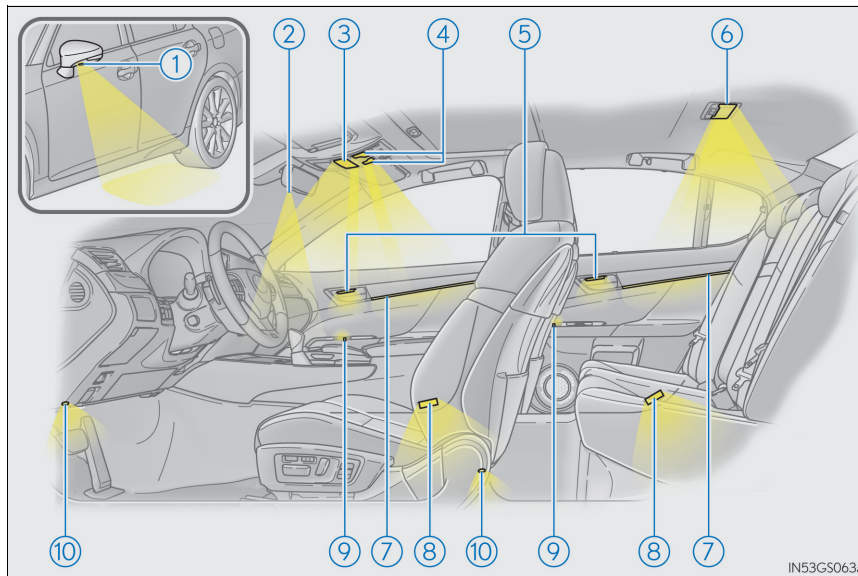

- | | |
|-----------------------------------|----------------------------------|
| ① Outer foot lights | ⑥ Rear personal lights (→P. 367) |
| ② Shift lever light | Rear interior light |
| ③ Front interior light (→P. 367) | ⑦ Ornament lights |
| ④ Front personal lights (→P. 367) | ⑧ Door courtesy lights |
| ⑤ Inside door handle lights | ⑨ Power window switch lights |
| | ⑩ Footwell lights |

When the instrument panel light control switch is turned to minimum and the tail lights are on, the inside door handle lights, the ornament lights and the footwell lights will turn off. (→P. 107)

Interior lights

- ① Turns the lights on/off
The rear interior light is also turned on/off.
- ② Turns the door position on/off

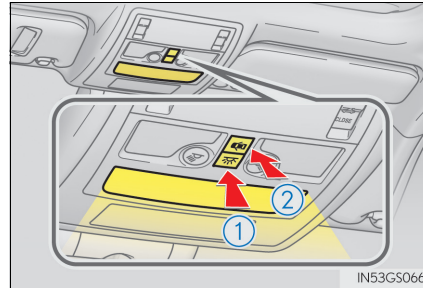

IN53GS066

Personal lights

■ Front

Turns the light on/off

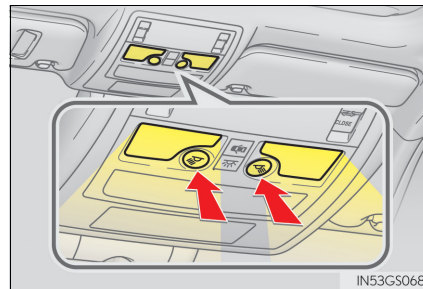

IN53GS068

■ Rear

Turns the light on/off

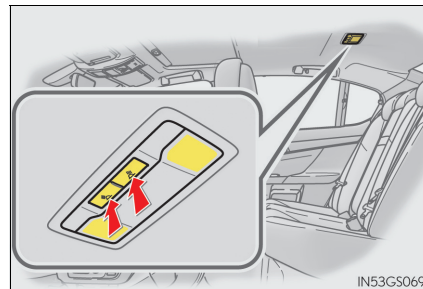

IN53GS069

- Illuminated entry system: The lights automatically turn on/off according to power switch mode, the presence of the electronic key, whether the doors are locked/unlocked, and whether the doors are opened/closed.
- If the interior lights remain on when the power switch is turned off, the lights will go off automatically after 20 minutes.
- Setting (e.g. the time elapsed before lights turn off) can be changed.
(Customizable features: →P. 561)

 NOTICE

To prevent 12-volt battery discharge, do not leave the lights on longer than necessary when the hybrid system is off.

List of storage features

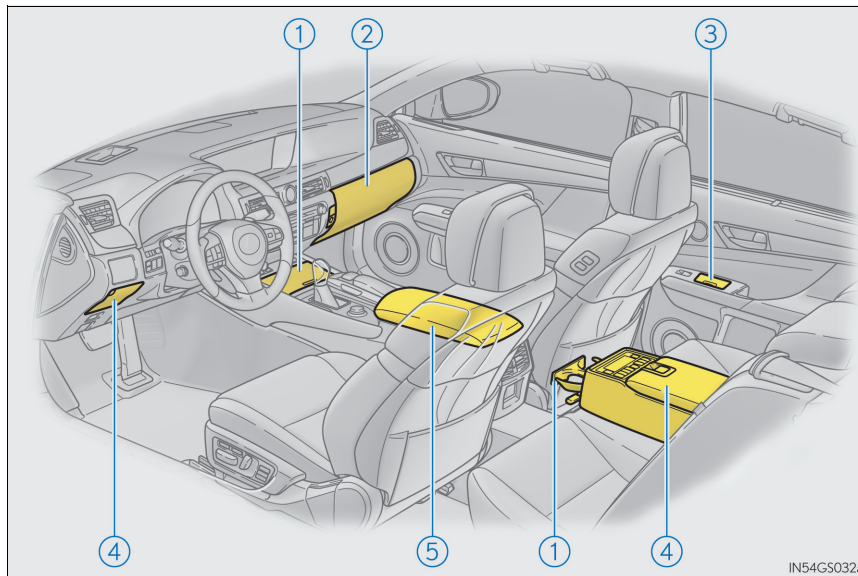

- | | | | |
|---------------------------------|-----------|-------------------|-----------|
| ① Cup holders | (→P. 371) | ④ Auxiliary boxes | (→P. 373) |
| ② Glove box | (→P. 370) | ⑤ Console box | (→P. 370) |
| ③ Auxiliary boxes (if equipped) | (→P. 373) | | |
| Ashtrays (if equipped) | (→P. 378) | | |

⚠ WARNING

- Do not leave glasses, lighters or spray cans in the storage spaces, as this may cause the following when cabin temperature becomes high:
 - Glasses may be deformed by heat or cracked if they come into contact with other stored items.
 - Lighters or spray cans may explode. If they come into contact with other stored items, the lighter may catch fire or the spray can may release gas, causing a fire hazard.
- When driving or when the storage compartments are not in use, keep the lids closed. In the event of sudden braking or sudden swerving, an accident may occur due to an occupant being struck by an open lid or the items stored inside.

Glove box

- ① Open (press the button)
- ② Unlock with the mechanical key
- ③ Lock with the mechanical key

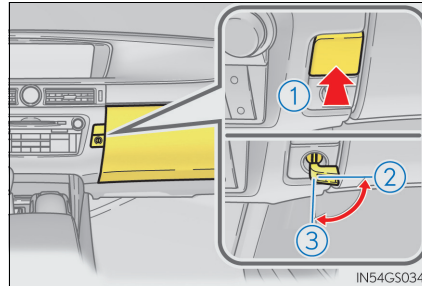

- The glove box light turns on when the tail lights are on.
- The trunk opener main switch is located in the glove box. (→P. 148)
- The insert inside the glove box can be removed.
- An SRS knee airbag for the front passenger's seat is built into the glove box door. (→P. 43)

Console box

- ① Using with half-open
Grip the knob to release the lock, and slide the armrest as far back.
- ② Using with fully open
Grip the knob to release the lock, and lift the armrest to open.

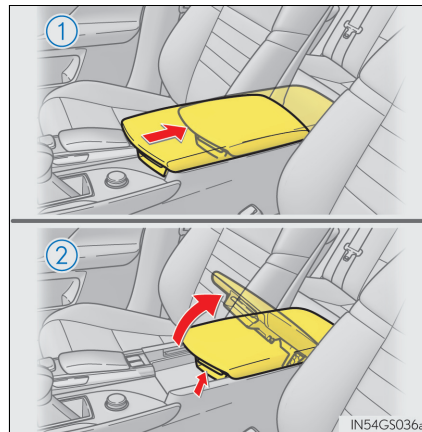

- The tray slides forward/backward and can be removed.

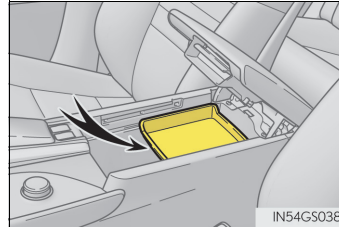

- The console box light turns on when the tail lights are on.

⚠ WARNING

When using the console box with half-open, do not apply too much load on the armrest. Doing so may damage the armrest and may cause you to injure yourself.

Cup holders

■ Front

To open, press down and release the cup holder lid.

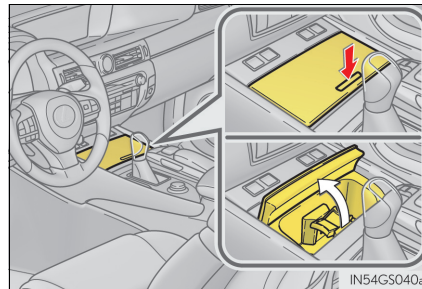

■ Rear

To open, pull down the armrest and press in and release the rear cup holder on the armrest.

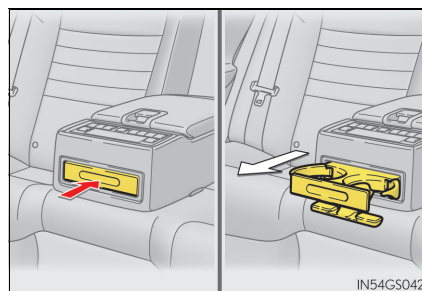

- Front cup holder: The cup holder insert may be removed for cleaning.

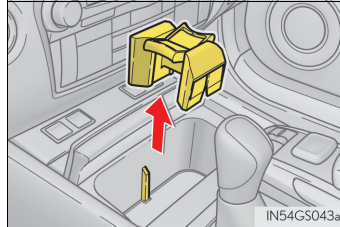

- Rear cup holder: When stowing the cup holder, stow the cup holder with the armrest down. The cup holder cannot be stowed if the armrest is not down.

⚠ WARNING

Do not place anything other than cups or beverage cans in the cup holders. Other items may be thrown out of the holders in the event of an accident or sudden braking, causing injury. If possible, cover hot drinks to prevent burns.

⚠ NOTICE

To prevent damage to the rear cup holder, stow the cup holder before stowing the armrest.

Auxiliary boxes

▶ Type A

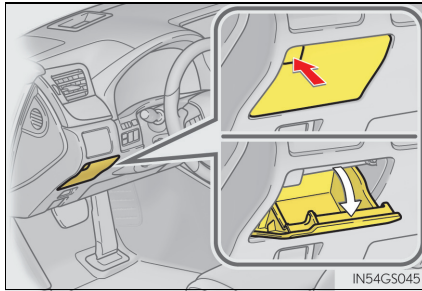

Press in the button.

▶ Type B

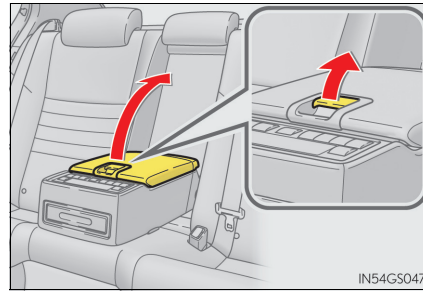

Pull up the lever to release the lock and lift the lid.

▶ Type C (if equipped)

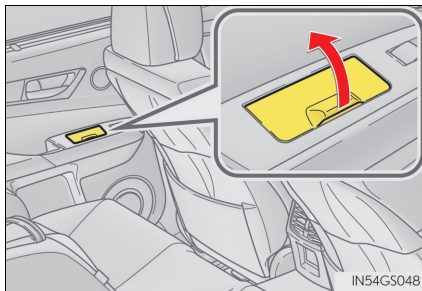

Open the lid.

⚠ WARNING

Type C: Do not use the auxiliary box as an ashtray. Doing so may cause a fire.

Trunk features

Cargo hooks

Raise the hooks when needed.

The cargo hooks are provided for securing loose items.

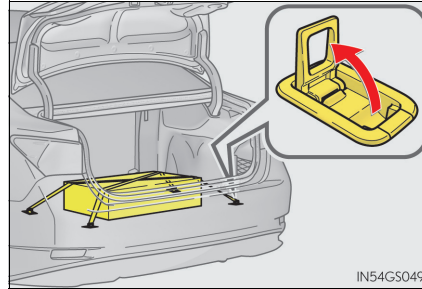

WARNING

To avoid injury, always return the cargo hooks to their stowed positions when not in use.

Luggage hook

Pull the strap when using the hook.

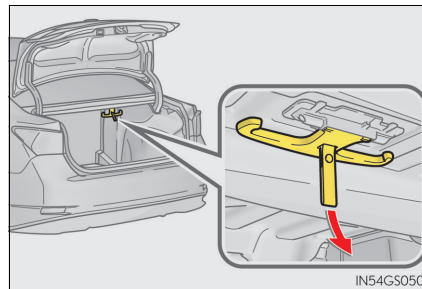

NOTICE

Do not hang any object heavier than 5 kg (11 lb.) on the luggage hook.

First-aid kit storage net

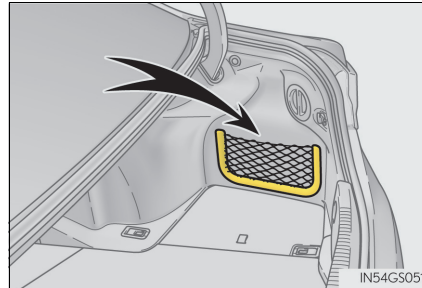

Luggage mat

► Type A

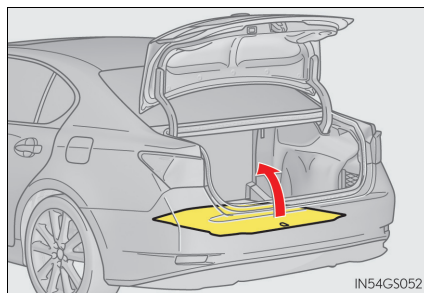

Pull the strap upwards to lift up the luggage mat.

► Type B

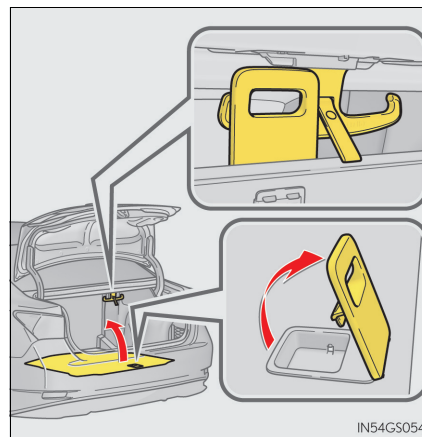

Pull the lever upwards to lift up the luggage mat.

The lever can be hooked on the luggage hook.

Warning reflector storage belt

- ① Loosen the belt
- ② Tighten the belt

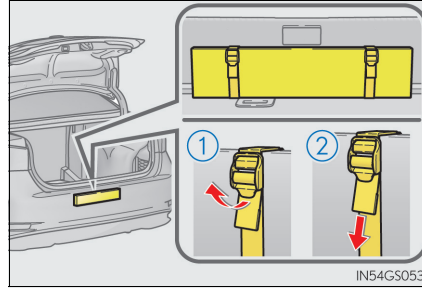

To prevent damage to the warning reflector storage belt when it is not in use, fold the belt (as shown in ①) and secure it with the clip (②).

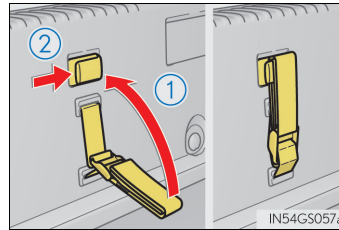

Other interior features

Sun visors

- ① To set the visor in the forward position, flip it down.
- ② To set the visor in the side position, flip down, unhook, and swing it to the side.
- ③ To use the side extender, place the visor in the side position, then slide it backward.

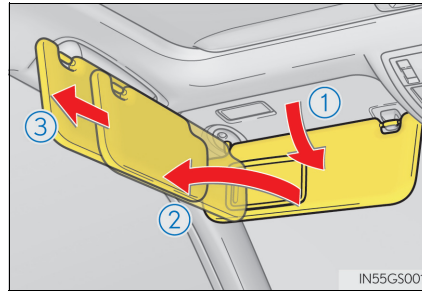

Vanity mirrors

Slide the cover to open.

The light turns on when the cover is opened.

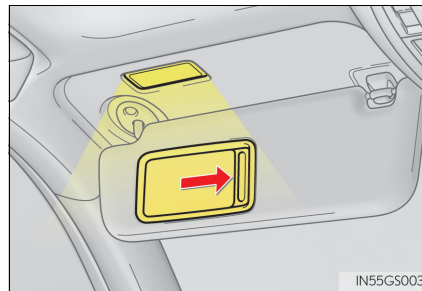

NOTICE

To prevent 12-volt battery discharge, do not leave the vanity lights on for extended periods while the hybrid system is off.

Clock

The GPS clock's time is automatically adjusted by utilizing GPS time information.

For details, refer to "NAVIGATION AND MULTIMEDIA SYSTEM OWNER'S MANUAL".

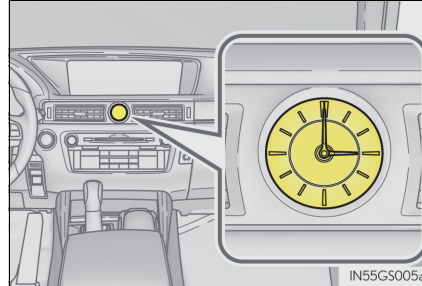

Ashtrays (if equipped)

Open the ashtray lid.

To remove the ashtray, pull the ashtray lid upwards.

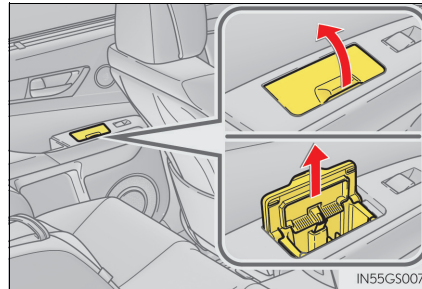

⚠ WARNING

- Keep the ashtray closed when not in use. In the event of sudden braking or sudden swerving, an accident may occur due to an occupant being struck by the open ashtray or ash flying out.
- To prevent fire
 - Fully extinguish matches and cigarettes before putting them in the ashtray, then make sure the ashtray is fully closed.
 - Do not place paper or any other type of flammable object in the ashtray.

Power outlets

Please use as a power supply for electronic goods that use less than 12 V DC / 10 A (power consumption of 120 W).

► Front

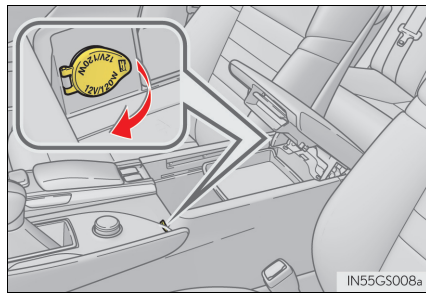

► Rear

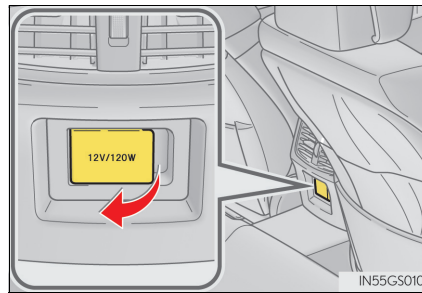

Open the lid.

The power outlets can be used when power switch is in ACCESSORY or ON mode.

NOTICE

- To avoid damaging the power outlets, close the power outlet lids when the power outlets are not in use.
Foreign objects or liquids that enter the power outlets may cause a short circuit.
- To prevent 12-volt battery discharge, do not use the power outlets longer than necessary when the hybrid system is off.

Armrest

Fold down the armrest for use.

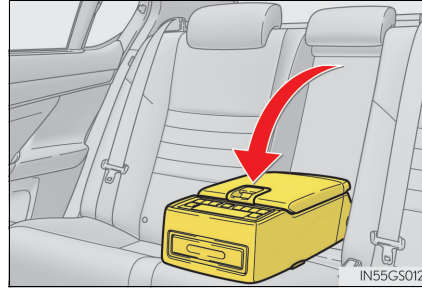

 NOTICE

To prevent damage to the armrest, do not apply too much load on the armrest.

Rear sunshade (if equipped)/rear door sunshades (if equipped)

■ Rear sunshade

The rear sunshade can be raised and lowered by operating the button shown below.

► From the front seats

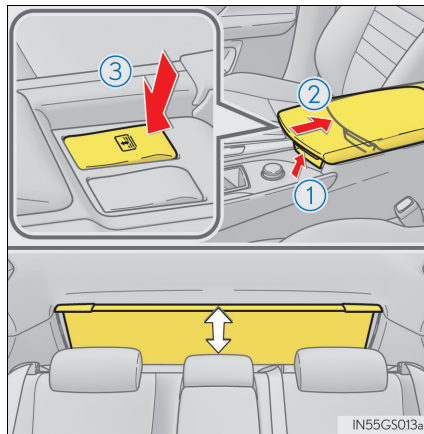

► From the rear seats (if equipped)

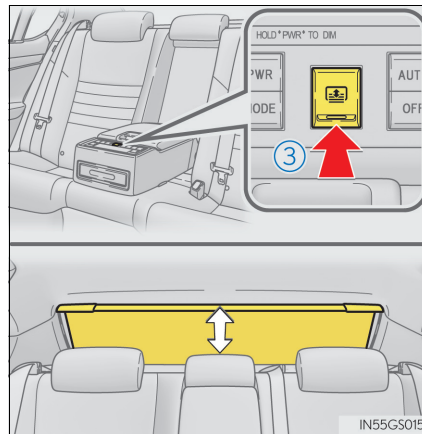

- ① Pull up the lever to release the lock.
- ② Slide the armrest.
- ③ Raise/lower

■ Rear door sunshades

Pull the tab of the rear door sunshade and hook the shade on using the anchors.

To retract the rear door sunshade, unhook the shade and retract it slowly.

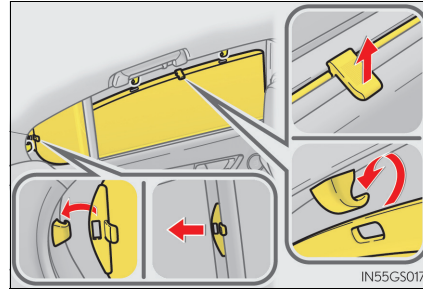

- The rear sunshade can be used when the power switch is in ON mode.
- The rear sunshade can be operated for approximately 1 minute even after the power switch is turned to ACCESSORY mode or turned off.
- Reverse operation feature: To ensure adequate rear visibility, the rear sunshade automatically lowers when the shift lever is shifted to R.

However, the rear sunshade is raised again if any of the following occurs:

- The button is pressed again.*
- Shift the shift lever into P.
- The shift lever is shifted out of R, and the vehicle reaches a speed of 15 km/h (9 mph).

If the hybrid system is off when the rear sunshade has been lowered due to the reverse operation feature, it will not be raised even when the hybrid system is turned on again and the vehicle reaches a speed of 15 km/h (9 mph). To raise the sunshade again, press the button.

*: Occasionally, the reverse function may not be carried out after the switch has been pressed. Repeat the above operation to operate the function.

- Vehicles with rear control panel: To prevent inadvertent operation, some buttons on the rear armrest can be locked. (→P. 360)
- Vehicles with rear control panel: Control panel illumination on the rear armrest can be turned off. (→P. 360)
- Time elapsed before the reverse operation feature activates can be changed. (Customizable features: →P. 561)

⚠ WARNING

When the rear sunshade is being operated, do not place fingers or other objects in the fastener section or in the opening. They may get caught, causing injury.

 NOTICE

- To prevent 12-volt battery discharge, do not operate the rear sunshade when the hybrid system is off.
- Observe the following precautions to ensure normal operation of the rear sunshade and rear door sunshades.
 - Do not place excessive load on the motor or other components of the rear sunshade.
 - Do not place objects where they may hinder opening and closing operations.
 - Do not attach items to the rear sunshade and rear door sunshades.
 - Keep the opening clean and clear of obstructions.
 - Do not operate the rear sunshade continuously for long periods of time.

Coat hooks

The coat hooks are provided with the rear assist grips.

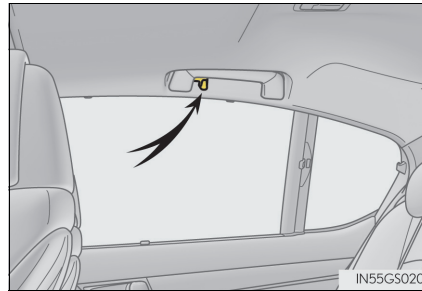

 WARNING

Do not hang coat hangers or other hard or sharp objects on the hook. If the SRS curtain shield airbags deploy, these items may become projectiles, causing death or serious injury.

Assist grips

An assist grip installed on the ceiling can be used to support your body while sitting on the seat.

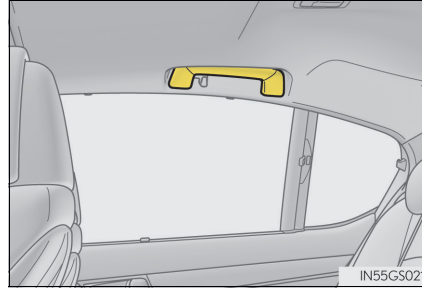

WARNING

Do not use the assist grip when getting in or out of the vehicle or rising from your seat.

NOTICE

To prevent damage to the assist grip, do not hang any heavy object or put a heavy load on the assist grip.

ERA-GLONASS*

ERA-GLONASS is a telematics service that uses Global Navigation Satellite System (GLONASS) data and embedded cellular technology to enable the following emergency calls to be made: Automatic emergency calls (Automatic Collision Notification) and manual emergency calls (by pressing the “SOS” button). This service is required by Eurasian Customs Union Regulations.

System components

- ① “SOS” button
- ② Indicator lights
- ③ Microphone

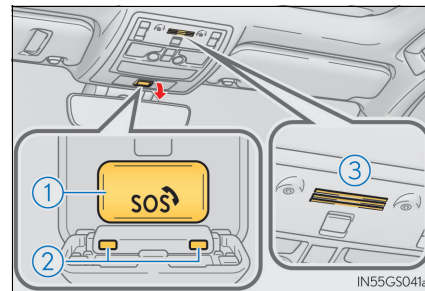

Emergency Notification Services

■ Automatic Collision Notification

If any airbag deploys, the system is designed to automatically call the Public Safety Answering Point (PSAP)*. The responding agent receives the vehicle’s location and attempts to speak with the vehicle occupants to assess the level of emergency. If the occupants are unable to communicate, the agent automatically treats the call as an emergency, contacts the nearest emergency services provider to describe the situation, and requests that assistance be sent to the location.

*: In some cases, the call cannot be made. (→P. 386)

*: If equipped

■ Emergency Assistance Button (“SOS”)

In the event of an emergency, push the “SOS” button to reach the Public Safety Answering Point (PSAP). The answering agent will determine your vehicle’s location, assess the emergency, and dispatch the necessary assistance required.

If you accidentally press the “SOS” button, tell the agent that you are not experiencing an emergency.

Indicator lights

When the power switch is turned to ON mode, the red indicator light will illuminate for 10 seconds and then the green indicator light will illuminate for 2 seconds, indicating that the system is enabled. The indicator lights indicate the following:

- If the green indicator light illuminates and stays on, the system is enabled.
- If the green indicator light flashes, an emergency call is being made (either automatically or manually).
- If no indicator lights illuminate, the system is not enabled.
- If the red indicator light illuminates any time other than immediately after the power switch is turned to ON mode, the system may be malfunctioning or the backup battery may be depleted. Contact any authorized Lexus retailer or Lexus authorized repairer, or any reliable repairer.

The service life of the backup battery is 3 years or more.

 **WARNING****■ When the Emergency Call may not be made**

- Any of the followings may occur. In such cases, report to the Public Safety Answering Point (PSAP) by other means such as nearby public phones.
 - It may sometimes be difficult to connect to the Public Safety Answering Point (PSAP) even in the reception area of the cellular phone due to the reception level, or if the line is busy.
In such cases, you may not be able to connect to the Public Safety Answering Point (PSAP) and thus will not be able to make emergency calls and report to the emergency departments even though the system tries to connect to the Public Safety Answering Point (PSAP).
 - When the vehicle is out of the cellular phone service area, the Emergency Call cannot be made.
 - When any related equipment (such as the "SOS" button panel, indicator lights, microphone, speaker, DCM, antenna, or any wires connecting the equipment.) has an abnormality, is damaged or broken, the Emergency Call cannot be made.
 - During the Emergency Call, the system makes repeated attempts to connect to the Public Safety Answering Point (PSAP). However, if it cannot connect to the Public Safety Answering Point (PSAP) due to poor radio wave reception, the system may not be able to connect to the cellular network and the call may finish without connecting. The red indicator light will blink for approximately 30 seconds to indicate this disconnection.
 - This device may not function if a shock is applied to it.
- If the 12-volt battery's voltage decreases or there is a disconnection, the system may not be able to access the Public Safety Answering Point (PSAP).

■ When replacing DCM to a new one

ERA-GLONASS have to be activated. Contact any authorized Lexus retailer or Lexus authorized repairer, or any reliable repairer.

 **WARNING**
■ For your safety

- Please drive safely.
The function of this system is to assist you in making the Emergency Call in case of accidents as traffic accidents or sudden medical emergencies, and it does not protect the driver or the passengers in any way. Please drive safely and fasten your seatbelts at all times for your safety.
- In case of an emergency, make lives the top priority.
- If you smell anything burning or another unusual smell, do not stay inside the vehicle and evacuate to a safe area immediately.
- Since the system detects shocks, the automatic reporting may not always occur synchronized with the operation of the airbag system. (If the vehicle is bumped from behind, etc.)
- The airbag may not inflate even in case of an accident, if it does not involve high impact. In such cases, the system may not make emergency calls automatically. The system may also not make automatic emergency calls even if the airbag has been inflated. If any of these should occur, please report to the Public Safety Answering Point (PSAP) by operating the "SOS" button.
- For safety, do not make the Emergency Call while driving.
Making calls during driving may cause mishandling of the steering wheel, which may lead to unexpected accidents.
Stop the vehicle and confirm the safety of the area before making the Emergency Call.
- When changing fuses, please use fuses that correspond to the described standard.
If you use fuses other than those described, it may cause ignition or smoke in the circuit and may lead to a fire.
- Using the system while there is smoke or an unusual smell may cause a fire. Stop using the system immediately and consult any authorized Lexus retailer or Lexus authorized repairer, or any reliable repairer.

 **NOTICE**
■ To prevent damage

Do not pour any liquid on to the "SOS" button panel etc. and make any impact to it.

■ If the "SOS" button panel malfunctions

It may not be able to make the Emergency Call or inform you of the correct condition of the system. If the "SOS" button panel has been broken, please consult any authorized Lexus retailer or Lexus authorized repairer, or any reliable repairer.

■ If there is any malfunction of the speaker or the microphone during the Emergency Call or the Manual Maintenance Check

You will not be able to communicate with the Public Safety Answering Point (PSAP) operator.

If any of this equipment has been broken, please consult any authorized Lexus retailer or Lexus authorized repairer, or any reliable repairer.

6-1. Maintenance and care

Cleaning and protecting
the vehicle exterior390

Cleaning and protecting
the vehicle interior..... 394

6-2. Maintenance

Maintenance
requirements 397

6-3. Do-it-yourself maintenance

Do-it-yourself service
precautions.....399

Hood 401

Positioning a floor jack 402

Engine compartment 403

12-volt battery 412

Tires 416

Tire inflation pressure 429

Wheels 431

Air conditioning filter 433

Electronic key battery..... 435

Checking and replacing
fuses..... 437

Light bulbs..... 442

Cleaning and protecting the vehicle exterior

Perform the following to protect the vehicle and maintain it in prime condition:

- Working from top to bottom, liberally apply water to the vehicle body, wheel wells and underside of the vehicle to remove any dirt and dust.
- Wash the vehicle body using a sponge or soft cloth, such as a chamois.
- For hard-to-remove marks, use car wash soap and rinse thoroughly with water.
- Wipe away any water.
- Wax the vehicle when the waterproof coating deteriorates.
If water does not bead on a clean surface, apply wax when the vehicle body is cool.

■ Self-restoring coat

The vehicle body has a self-restoring coating that is resistant to small surface scratches caused in a car wash etc.

- The coating lasts for 5 to 8 years from when the vehicle is delivered from the plant.
- The restoration time differs depending on the depth of the scratch and outside temperature. The restoration time may become shorter when the coating is warmed by applying warm water.
- Deep scratches caused by keys, coins, etc. cannot be restored.
- Do not use wax that contain abrasives.

■ Automatic car washes

- Fold the mirrors before washing the vehicle. Start washing from the front of the vehicle. Make sure to extend the mirrors before driving.
- Brushes used in automatic car washes may scratch the vehicle surface and harm your vehicle's paint.
- Rear spoiler (if equipped) may not be washable in some automatic car washes. There may also be an increased risk of damage to vehicle.

■ High-pressure car washes

- Do not allow the nozzles of the car wash to come within close proximity of the windows.
- Before using the car wash, check that the fuel filler door on your vehicle is closed properly.

■ Notes for a smart entry & start system (vehicles with entry function)

If the door handle becomes wet while the electronic key is within the effective range, the door may lock and unlock repeatedly. In that case, follow the following correction procedures to wash the vehicle:

- Place the key in a position 2 m (6 ft.) or more separate from the vehicle while the vehicle is being washed. (Take care to ensure that the key is not stolen.)
- Set the electronic key to battery-saving mode to disable the smart entry & start system. (→P. 155)

■ Aluminum wheels

- Remove any dirt immediately by using a neutral detergent. Do not use hard brushes or abrasive cleaners. Do not use strong or harsh chemical cleaners. Use the same mild detergent and wax as used on the paint.
- Do not use detergent on the wheels when they are hot, for example after driving for long distance in the hot weather.
- Wash detergent from the wheels immediately after use.

■ Brake caliper coating (vehicles with orange brake calipers for F SPORT models)

- When using detergent, use neutral detergent. Do not use hard brushes or abrasive cleaners, as they will damage the coating.
- Do not use detergent on the brake calipers when they are hot.
- Wash detergent off immediately after use.

■ Bumpers

Do not scrub with abrasive cleaners.

■ Front side windows water-repellent coating

- The following precautions can extend the effectiveness of the water-repellent coating.
 - Remove any dirt, etc. from the front side windows regularly.
 - Do not allow dirt and dust to accumulate on the windows for a long period. Clean the windows with a soft, damp cloth as soon as possible.
 - Do not use wax or glass cleaners that contain abrasives when cleaning the windows.
 - Do not use any metallic objects to remove condensation build up.
- When the water-repellent performance has become insufficient, the coating can be repaired. Contact any authorized Lexus retailer or Lexus authorized repairer, or any reliable repairer.

⚠ WARNING

■ **When washing the vehicle**

Do not apply water to the inside of the engine compartment. Doing so may cause the electrical components etc. to catch fire.

■ **When cleaning the windshield (vehicles with rain-sensing windshield wipers)**

Turn off AUTO mode of the wiper to prevent the wiper from operating. (→P. 251)

If AUTO mode is selected, the wipers may operate unexpectedly in the following situations, and may result in hands being caught or other serious injuries and cause damage to the wiper blades.

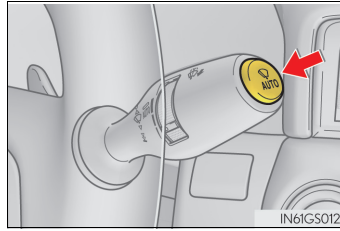

- When the upper part of the windshield where the raindrop sensor is located is touched by hand
- When a wet rag or similar is held close to the raindrop sensor
- If something bumps against the windshield
- If you directly touch the raindrop sensor body or if something bumps into the raindrop sensor

■ **Precautions regarding the exhaust pipes**

Exhaust gases cause the exhaust pipes to become quite hot.

When washing the vehicle, be careful not to touch the pipes until they have cooled sufficiently, as touching hot exhaust pipes can cause burns.

■ **Precaution regarding the rear bumper with Blind Spot Monitor (if equipped)**

If the paint of the rear bumper is chipped or scratched, the system may malfunction. If this occurs, consult any authorized Lexus retailer or Lexus authorized repairer, or any reliable repairer.

 NOTICE

■ **To prevent paint deterioration and corrosion on the body and components (aluminum wheels etc.)**

- Wash the vehicle immediately in the following cases:
 - After driving near the sea coast
 - After driving on salted roads
 - If coal tar, pollen or tree sap is present on the paint surface
 - If dead insects, insect droppings or bird droppings are present on the paint surface
 - After driving in an area contaminated with soot, oily smoke, mine dust, iron powder or chemical substances
 - If the vehicle becomes heavily soiled with dust or mud
 - If liquids such as benzene and gasoline are spilled on the paint surface
- If the paint is chipped or scratched, have it repaired immediately.
- To prevent the wheels from corroding, remove any dirt and store in a place with low humidity when storing the wheels.

■ **Cleaning the exterior lights**

- Wash carefully. Do not use organic substances or scrub with a hard brush. This may damage the surfaces of the lights.
- Do not apply wax to the surfaces of the lights. Wax may cause damage to the lenses.

■ **When using an automatic car wash (vehicles with rain-sensing windshield wipers)**

Turn off AUTO mode of the wiper to prevent the wiper from operating. (→P. 251)
If AUTO mode is selected, the wipers may operate and the wiper blades may be damaged.

■ **When using a high-pressure car wash**

- When washing the vehicle, do not let water from the high-pressure washer directly hit the camera or the area around the camera. Due to the shock from high-pressure water, it is possible that the device may not operate normally.
- Do not bring the nozzle tip close to boots (rubber or resin manufactured cover), connectors or the following parts. The parts may be damaged if they come into contact with high-pressure water.

• Traction related parts	• Steering parts
• Suspension parts	• Brake parts

Cleaning and protecting the vehicle interior

The following procedures will help protect your vehicle's interior and keep it in top condition:

Protecting the vehicle interior

- Remove dirt and dust using a vacuum cleaner. Wipe dirty surfaces with a cloth dampened with lukewarm water.
- If dirt cannot be removed, wipe it off with a soft cloth dampened with neutral detergent diluted to approximately 1%.

Wring out any excess water from the cloth and thoroughly wipe off remaining traces of detergent and water.

Cleaning the areas with satin-finish metal accents

- Remove dirt using a soft cloth or synthetic chamois dampened in a baking soda (sodium bicarbonate) solution.
Use a solution of approximately 9% baking soda dissolved in water.
- Wipe the surface with a dry, soft cloth to remove any remaining moisture.

Cleaning the leather areas

- Remove dirt and dust using a vacuum cleaner.
- Wipe off any excess dirt and dust with a soft cloth dampened with diluted detergent.
Use a diluted water solution of approximately 5% neutral wool detergent.
- Wring out any excess water from the cloth and thoroughly wipe off all remaining traces of detergent.
- Wipe the surface with a dry, soft cloth to remove any remaining moisture.
Allow the leather to dry in a shaded and ventilated area.

Cleaning the synthetic leather areas

- Remove dirt and dust using a vacuum cleaner.
- Wipe it off with a soft cloth dampened with neutral detergent diluted to approximately 1%.
- Wring out any excess water from the cloth and thoroughly wipe off remaining traces of detergent and water.

■ Caring for leather areas

Lexus recommends cleaning the interior of the vehicle at least twice a year to maintain the quality of the vehicle's interior.

■ Shampooing the carpets

There are several commercial foaming-type cleaners available. Use a sponge or brush to apply the foam. Rub in overlapping circles. Do not use water. Wipe dirty surfaces and let them dry. Excellent results are obtained by keeping the carpet as dry as possible.

■ Seat belts

Clean with mild soap and lukewarm water using a cloth or sponge. Also check the belts periodically for excessive wear, fraying or cuts.

■ When cleaning the carpeted portions of the glove box, console box, etc.

If a strong adhesive tape is used, there is a possibility that the surface of the carpet could be damaged.

⚠ WARNING**■ Water in the vehicle**

- Do not splash or spill liquid in the vehicle, such as on the floor, in the hybrid battery (traction battery) air vents, and in the trunk.
Doing so may cause the hybrid battery, electrical components, etc. to malfunction or catch fire.

- Do not get any of the SRS components or wiring in the vehicle interior wet. (→P. 44)
An electrical malfunction may cause the airbags to deploy or not function properly, resulting in death or serious injury.

■ Cleaning the interior (especially instrument panel)

Do not use polish wax or polish cleaner. The instrument panel may reflect off the windshield, obstructing the driver's view and leading to an accident, resulting in death or serious injury.

 NOTICE**■ Cleaning detergents**

- Do not use the following types of detergent, as they may discolor the vehicle interior or cause streaks or damage to painted surfaces:
 - Non-seat portions: Organic substances such as benzene or gasoline, alkaline or acidic solutions, dye, and bleach
 - Seats: Alkaline or acidic solutions, such as thinner, benzene, and alcohol
- Do not use polish wax or polish cleaner. The instrument panel's or other interior part's painted surface may be damaged.

■ Preventing damage to leather surfaces

Observe the following precautions to avoid damage to and deterioration of leather surfaces:

- Remove any dust or dirt from leather surfaces immediately.
- Do not expose the vehicle to direct sunlight for extended periods of time. Park the vehicle in the shade, especially during summer.
- Do not place items made of vinyl, plastic, or containing wax on the upholstery, as they may stick to the leather surface if the vehicle interior heats up significantly.

■ Water on the floor

Do not wash the vehicle floor with water.

Vehicle systems such as the audio system may be damaged if water comes into contact with electrical components such as the audio system above or under the floor of the vehicle. Water may also cause the body to rust.

■ When cleaning the inside of the windshield (vehicles with Lexus Safety System+)

Do not allow glass cleaner to contact the lens. Also, do not touch the lens. (→P. 263)

■ Cleaning the inside of the rear window

- Do not use glass cleaner to clean the rear window, as this may cause damage to the rear window defogger heater wires or antenna. Use a cloth dampened with lukewarm water to gently wipe the window clean. Wipe the window in strokes running parallel to the heater wires or antenna.
- Be careful not to scratch or damage the heater wires or antenna.

Maintenance requirements

To ensure safe and economical driving, day-to-day care and regular maintenance are essential. Lexus recommends the following maintenance:

Scheduled maintenance

Scheduled maintenance should be performed at specified intervals according to the maintenance schedule.

For details about maintenance items and schedules, refer to the “Lexus Service Booklet” or “Lexus Warranty Booklet”.

Do-it-yourself maintenance

What about do-it-yourself maintenance?

Many of the maintenance items are easy to do yourself if you have a little mechanical ability and a few basic automotive tools.

Note, however, that some maintenance tasks require special tools and skills. These are best performed by qualified technicians. Even if you're an experienced do-it-yourself mechanic, we recommend that repairs and maintenance be conducted by any authorized Lexus retailer or Lexus authorized repairer, or any reliable repairer. Any authorized Lexus retailer or repairer will keep a record of maintenance, which could be useful should you ever require Warranty Service. Should you choose to select a qualified and equipped professional other than an authorized Lexus repairer to service or maintain your vehicle, we recommend that you request that a record of maintenance be kept.

■ Where to go for maintenance service?

In order to maintain your vehicle in the best possible condition, Lexus recommends that maintenance service operations as well as other inspections and repairs be carried out by authorized Lexus retailers or Lexus authorized repairers, or any reliable repairers. For repairs and services covered by your warranty, please visit an authorized Lexus retailer or repairer, who will use genuine Lexus parts in repairing any difficulties you may encounter. There can also be advantages in utilizing authorized Lexus retailers or repairers for non-warranty repairs and services, as members of the Lexus network will be able to expertly assist you with any difficulties you may encounter.

Your Lexus retailer or Lexus authorized repairer, or any reliable repairer will perform all of the scheduled maintenance on your vehicle reliably and economically due to their experience with Lexus vehicles.

■ Does your vehicle need repairs?

Be on the alert for changes in performance and sounds, and visual tip-offs that indicate service is needed. Some important clues are:

- Engine missing, stumbling or pinging
- Appreciable loss of power
- Strange engine noises
- A fluid leak under the vehicle (However, water dripping from the air conditioning system after use is normal.)
- Change in exhaust sound (This may indicate a dangerous carbon monoxide leak. Drive with the windows open and have the exhaust system checked immediately.)
- Flat-looking tires, excessive tire squeal when cornering, uneven tire wear
- Vehicle pulls to one side when driven straight on a level road
- Strange noises related to suspension movement
- Loss of brake effectiveness, spongy feeling brake pedal, pedal almost touches the floor, vehicle pulls to one side when braking
- Engine coolant temperature continually higher than normal (→P. 105)

If you notice any of these clues, take your vehicle to any authorized Lexus retailer or Lexus authorized repairer, or any reliable repairer as soon as possible. Your vehicle may need adjustment or repair.

⚠ WARNING**■ If your vehicle is not properly maintained**

Improper maintenance could result in serious damage to the vehicle and possible death or serious injury.

■ Handling of the 12-volt battery

12-volt battery posts, terminals and related accessories contain lead and lead compounds which are known to cause brain damage. Wash your hands after handling. (→P. 412)

Do-it-yourself service precautions

If you perform maintenance by yourself, be sure to follow the correct procedure as given in these sections.

Items	Parts and tools
12-volt battery condition (→P. 412)	<ul style="list-style-type: none"> • Grease • Conventional wrench (for terminal clamp bolts)
Engine/power control unit coolant level (→P. 409)	<ul style="list-style-type: none"> • "Toyota Super Long Life Coolant" or a similar high quality ethylene glycol-based non-silicate, non-amine, non-nitrite and non-borate coolant with long-life hybrid organic acid technology "Toyota Super Long Life Coolant" is pre-mixed with 50% coolant and 50% deionized water. • Funnel (used only for adding coolant)
Engine oil level (→P. 406)	<ul style="list-style-type: none"> • "Toyota Genuine Motor Oil" or equivalent • Rag or paper towel • Funnel (used only for adding engine oil)
Fuses (→P. 437)	<ul style="list-style-type: none"> • Fuse with same amperage rating as original
Light bulbs (→P. 442)	<ul style="list-style-type: none"> • Bulb with same number and wattage rating as original • Phillips-head screwdriver • Flathead screwdriver • Wrench
Radiator and condenser (→P. 411)	—
Tire inflation pressure (→P. 429)	<ul style="list-style-type: none"> • Tire pressure gauge • Compressed air source
Washer fluid (→P. 411)	<ul style="list-style-type: none"> • Water or washer fluid containing antifreeze (for winter use) • Funnel (used only for adding water or washer fluid)

 **WARNING**

The engine compartment contains many mechanisms and fluids that may move suddenly, become hot, or become electrically energized. To avoid death or serious injury, observe the following precautions.

■ When working on the engine compartment

- Make sure that the "POWER ON" on the multi-information display and the "READY" indicator are both off.
- Keep hands, clothing and tools away from the moving fan and engine drive belt.
- Be careful not to touch the engine, power control unit, radiator, exhaust manifold, etc. right after driving as they may be hot. Oil and other fluids may also be hot.
- Do not leave anything that may burn easily, such as paper and rags, in the engine compartment.
- Do not smoke, cause sparks or expose an open flame to fuel. Fuel fumes are flammable.
- Take care because brake fluid can harm your hands or eyes and damage painted surfaces. If fluid gets on your hands or in your eyes, flush the affected area with clean water immediately. If you still experience discomfort, consult a doctor.

■ When working near the electric cooling fans or radiator grille

Be sure the power switch is off.

With the power switch in ON mode, the electric cooling fans may automatically start to run if the air conditioning is on and/or the coolant temperature is high. (→P. 411)

■ Safety glasses

Wear safety glasses to prevent flying or falling material, fluid spray, etc. from getting in your eyes.

 **NOTICE****■ If you remove the air cleaner filter**

Driving with the air cleaner filter removed may cause excessive engine wear due to dirt in the air.

■ If the fluid level is low or high

It is normal for the brake fluid level to go down slightly as the brake pads wear or when the fluid level in the accumulator is high.

If the reservoir needs frequent refilling, it may indicate a serious problem.

Hood

Release the lock from the inside of the vehicle to open the hood.

- 1 Pull the hood lock release lever.
The hood will pop up slightly.

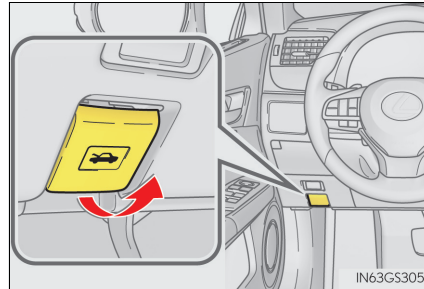

- 2 Pull up the auxiliary catch lever and lift the hood.

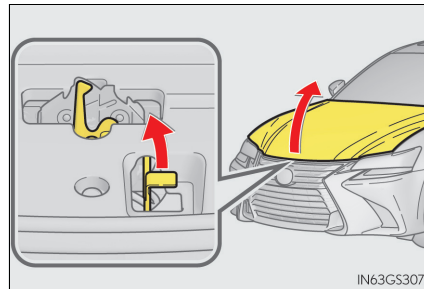

WARNING

■ Pre-driving check

Check that the hood is fully closed and locked.
If the hood is not locked properly, it may open while the vehicle is in motion and cause an accident, which may result in death or serious injury.

Positioning a floor jack

When using a floor jack, follow the instructions in the manual provided with the jack and perform the operation safely.

When raising your vehicle with a floor jack, position the jack correctly. Improper placement may damage your vehicle or cause injury.

◆ Front

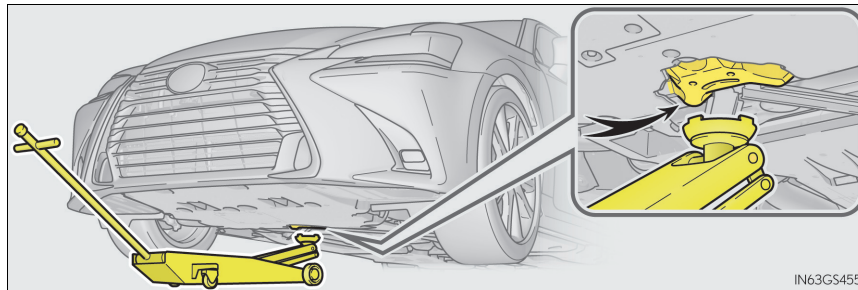

◆ Rear

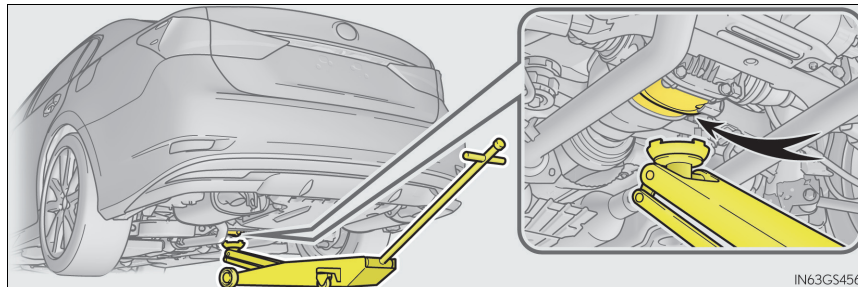

Engine compartment

▶ GS450h

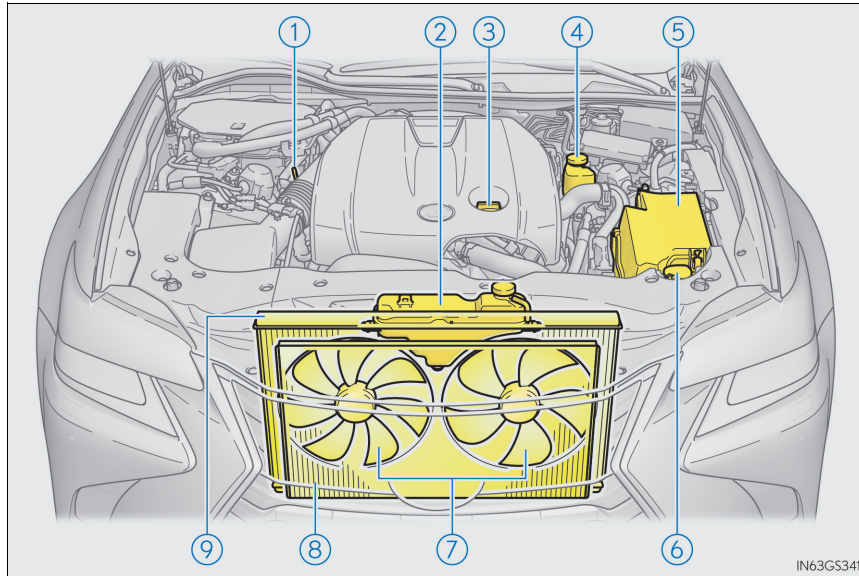

- | | |
|--|--------------------------------------|
| ① Engine oil level dipstick
(→P. 406) | ⑤ Fuse box
(→P. 437) |
| ② Engine coolant reservoir
(→P. 409) | ⑥ Washer fluid tank
(→P. 411) |
| ③ Engine oil filler cap
(→P. 407) | ⑦ Electric cooling fans
(→P. 411) |
| ④ Power control unit coolant
reservoir
(→P. 409) | ⑧ Condenser
(→P. 411) |
| | ⑨ Radiator
(→P. 411) |

■ 12-volt battery

→P. 412

▶ GS300h

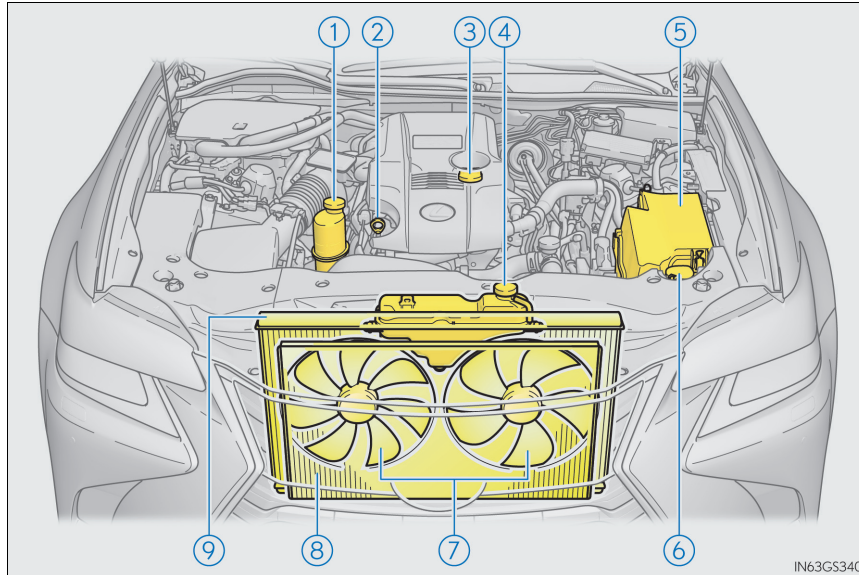

- | | |
|--|-------------------------------|
| ① Power control unit coolant reservoir (→P. 409) | ⑤ Fuse box (→P. 437) |
| ② Engine oil level dipstick (→P. 406) | ⑥ Washer fluid tank (→P. 411) |
| ③ Engine oil filler cap (→P. 407) | ⑦ Electric cooling fans |
| ④ Engine coolant reservoir (→P. 409) | ⑧ Condenser (→P. 411) |
| | ⑨ Radiator (→P. 411) |

■ 12-volt battery
→P. 412

Engine compartment cover

■ Removing the engine compartment cover

▶ Right-hand side

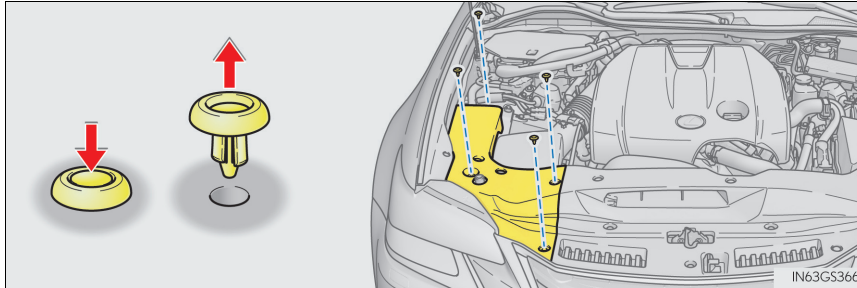

▶ Center

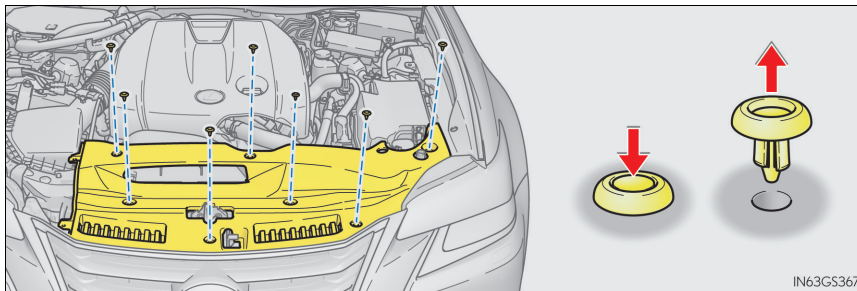

■ Installing the clips

- ① Push up center portion
- ② Insert
- ③ Press

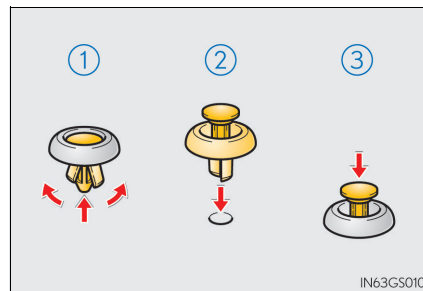

⚠ NOTICE

■ Checking the engine compartment cover after installation

Make sure that the cover is securely installed in its original position.

Engine oil

With the engine at operating temperature and turned off, check the oil level on the dipstick.

■ Checking the engine oil

1 Park the vehicle on level ground. After warming up the engine and turning off the hybrid system, wait more than 5 minutes for the oil to drain back into the bottom of the engine.

2 Holding a rag under the end, pull the dipstick out.

▶ GS450h

▶ GS300h

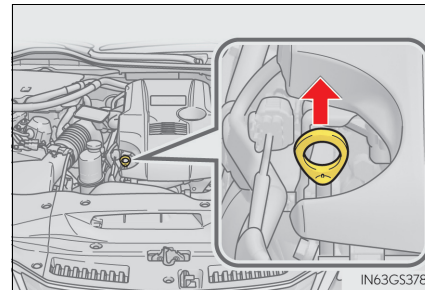
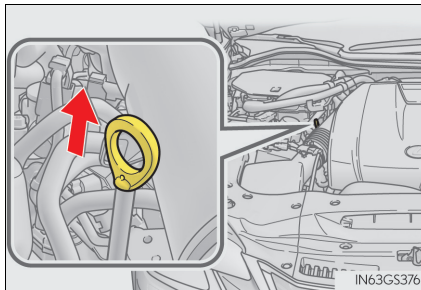

3 Wipe the dipstick clean.

4 Reinsert the dipstick fully.

5 Holding a rag under the end, pull the dipstick out and check the oil level.

① Low

② Normal

③ Excessive

▶ Flat dipstick

▶ Non-flat dipstick

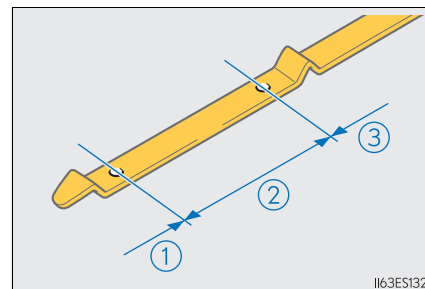
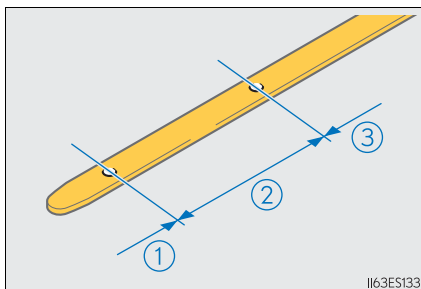

The shape of the dipstick may differ depending on the type of vehicle or engine.

6 Wipe the dipstick and reinsert it fully.

■ Adding engine oil

If the oil level is below or near the low level mark, add engine oil of the same type as that already in the engine.

▶ GS450h

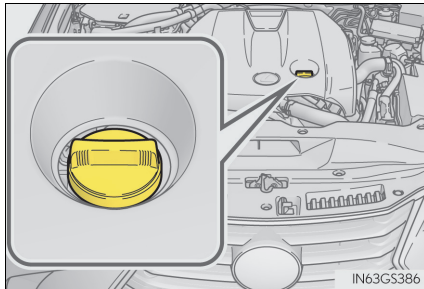

▶ GS300h

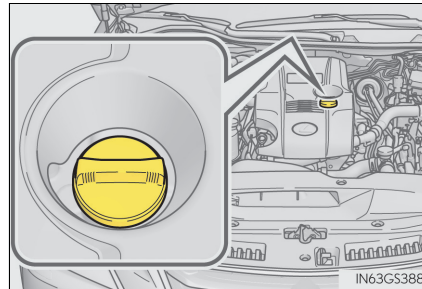

Make sure to check the oil type and prepare the items needed before adding oil.

Engine oil selection	→P. 550
Oil quantity (Low → Full)	1.5 L (1.6 qt., 1.3 Imp.qt.)
Items	Clean funnel

- 1 Remove the oil filler cap by turning it counterclockwise.
- 2 Add engine oil slowly, checking the dipstick.
- 3 Install the oil filler cap by turning it clockwise.

■ Engine oil consumption

A certain amount of engine oil will be consumed while driving. In the following situations, oil consumption may increase, and engine oil may need to be refilled in between oil maintenance intervals.

- When the engine is new, for example directly after purchasing the vehicle or after replacing the engine
- If low quality oil or oil of an inappropriate viscosity is used
- When driving at high engine speeds or with a heavy load, when towing, or when driving while accelerating or decelerating frequently
- When leaving the engine idling for a long time, or when driving frequently through heavy traffic

■ **After changing the engine oil**

The engine oil maintenance data should be reset. Perform the following procedures:

- 1 Press **<** or **>** of the meter control switch and select .
- 2 Press **▲** or **▼** of the meter control switch and select "Vehicle Settings". Then press **●**.
- 3 Press **▲** or **▼** of the meter control switch and select "Oil Maintenance". Then press **●**.
- 4 Select the "Yes" and press **●**.
- 5 A message is displayed on the multi-information display.



⚠ WARNING

■ **Used engine oil**

- Used engine oil contains potentially harmful contaminants which may cause skin disorders such as inflammation and skin cancer, so care should be taken to avoid prolonged and repeated contact. To remove used engine oil from your skin, wash thoroughly with soap and water.
- Dispose of used oil and filters only in a safe and acceptable manner. Do not dispose of used oil and filters in household trash, in sewers or onto the ground. Call any authorized Lexus retailer or Lexus authorized repairer, or any reliable repairer, service station or auto parts store for information concerning recycling or disposal.
- Do not leave used engine oil within the reach of children.

⚠ NOTICE

■ **To prevent serious engine damage**
Check the oil level on a regular basis.

■ **When replacing the engine oil**

- Be careful not to spill engine oil on the vehicle components.
- Avoid overfilling, or the engine could be damaged.
- Check the oil level on the dipstick every time you refill the vehicle.
- Be sure the engine oil filler cap is properly tightened.

Coolant

The coolant level is satisfactory if it is between the "FULL"/"F" and "LOW"/"L" lines on the reservoir when the hybrid system is cold.

■ Engine coolant reservoir

- ① Reservoir cap
- ② "FULL" line
- ③ "LOW" line

▶ GS450h

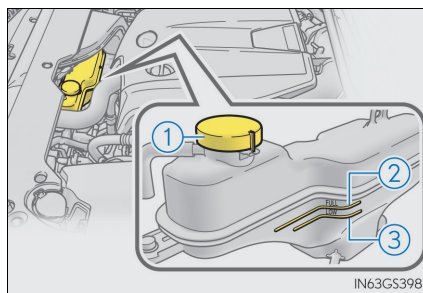

▶ GS300h

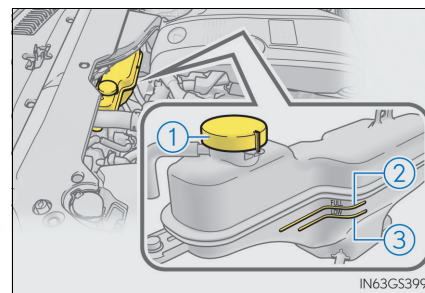

If the level is on or below the "LOW" line, add coolant up to the "FULL" line.
(→P. 535)

■ Power control unit coolant reservoir

▶ GS450h

- ① Reservoir cap
- ② "FULL" line
- ③ "LOW" line

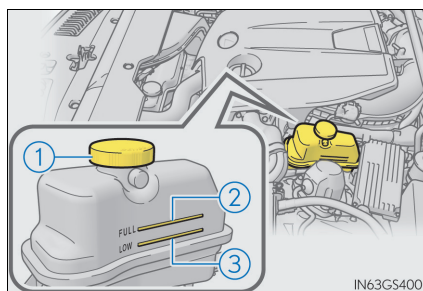

If the level is on or below the "LOW" line, add coolant up to the "FULL" line.
(→P. 535)

▶ GS300h

- ① Reservoir cap
- ② "F" line
- ③ "L" line

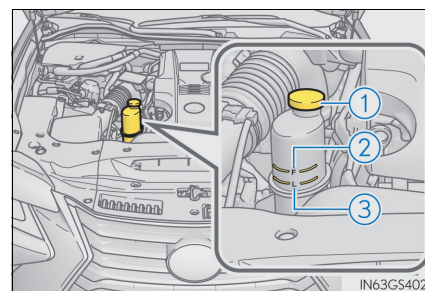

If the level is on or below the "L" line, add coolant up to the "F" line.
(→P. 535)

■ **Coolant selection**

Only use "Toyota Super Long Life Coolant" or a similar high quality ethylene glycol based non-silicate, non-amine, non-nitrite, and non-borate coolant with long-life hybrid organic acid technology.

"Toyota Super Long Life Coolant" is a mixture of 50% coolant and 50% deionized water. (Minimum temperature: -35°C [-31°F])

For more details about coolant, contact any authorized Lexus retailer or Lexus authorized repairer, or any reliable repairer.

■ **If the coolant level drops within a short time of replenishing**

Visually check the radiator, hoses, engine/power control unit coolant reservoir caps, drain cock and water pump.

If you cannot find a leak, have any authorized Lexus retailer or Lexus authorized repairer, or any reliable repairer, test the cap and check for leaks in the cooling system.

 **WARNING**

■ **When the hybrid system is hot**

Do not remove the engine/power control unit coolant reservoir caps or the coolant inlet cap. (→P. 540)

The cooling system may be under pressure and may spray hot coolant if the cap is removed, causing serious injuries, such as burns.

 **NOTICE**

■ **When adding coolant**

Coolant is neither plain water nor straight antifreeze. The correct mixture of water and antifreeze must be used to provide proper lubrication, corrosion protection and cooling. Be sure to read the antifreeze or coolant label.

■ **If you spill coolant**

Be sure to wash it off with water to prevent it from damaging parts or paint.

Radiator and condenser

Check the radiator and condenser and clear away any foreign objects. If either of the above parts is extremely dirty or you are not sure of their condition, have your vehicle inspected by any authorized Lexus retailer or Lexus authorized repairer, or any reliable repairer.

WARNING

■ When the hybrid system is hot

Do not touch the radiator or condenser as they may be hot and cause serious injuries, such as burns.

Washer fluid

If any washer does not work or the warning message appears on the multi-information display, the washer tank may be empty. Add washer fluid.

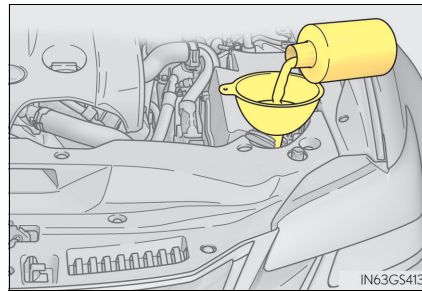

WARNING

■ When adding washer fluid

Do not add washer fluid when the hybrid system is hot or operating as washer fluid contains alcohol and may catch fire if spilled on the engine etc.

NOTICE

■ Do not use any fluid other than washer fluid

Do not use soapy water or engine antifreeze instead of washer fluid. Doing so may cause streaking on the vehicle's painted surfaces.

■ Diluting washer fluid

Dilute washer fluid with water as necessary. Refer to the freezing temperatures listed on the label of the washer fluid bottle.

12-volt battery

Location

The 12-volt battery is located on the left-hand side of trunk.

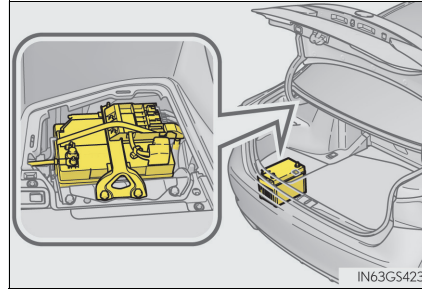

Removing the 12-volt battery cover

Pull the strap upwards to lift up the 12-volt battery cover.

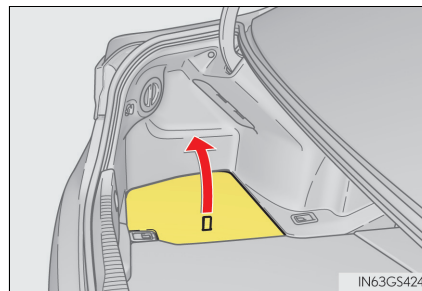

Exterior





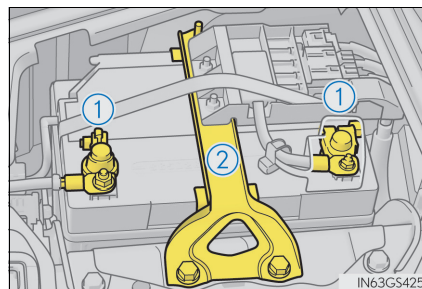

Make sure that the 12-volt battery terminals are not corroded and that there are no loose connections, cracks, or loose clamps.

- ① Terminals
- ② Hold-down clamp



Caution symbols

The meanings of each caution symbol on the top of the 12-volt battery are as follows:

	No smoking, no naked flames, no sparks		12-volt battery acid
	Shield eyes		Note operating instructions
	Keep away from children		Explosive gas

■ Before recharging

When recharging, the 12-volt battery produces hydrogen gas which is flammable and explosive. Therefore, observe the following precautions before recharging:

- If recharging with the 12-volt battery installed on the vehicle, be sure to disconnect the ground cable.
- Make sure the power switch on the charger is off when connecting and disconnecting the charger cables to the 12-volt battery.

■ After recharging/reconnecting the 12-volt battery

- The hybrid system may not start. Follow the procedure below to initialize the system.
 - 1 Shift the shift lever to P.
 - 2 Open and close any of the doors.
 - 3 Restart the hybrid system.
- Unlocking the doors using the smart entry & start system may not be possible immediately after reconnecting the 12-volt battery. If this happens, use the wireless remote control or the mechanical key to lock/unlock the doors.
- Start the hybrid system with the power switch in ACCESSORY mode. The hybrid system may not start with the power switch turned off. However, the hybrid system will operate normally from the second attempt.
- The power switch mode is recorded by the vehicle. If the 12-volt battery is reconnected, the vehicle will return the power switch mode to the status it was in before the 12-volt battery was disconnected. Make sure to turn off the power switch before disconnect the 12-volt battery. Take extra care when connecting the 12-volt battery if the power switch mode prior to discharge is unknown.

If the system will not start even after multiple attempts at all methods above, contact any authorized Lexus retailer or Lexus authorized repairer, or any reliable repairer.

 **WARNING****■ Chemicals in the 12-volt battery**

The 12-volt battery contains poisonous and corrosive sulfuric acid and may produce hydrogen gas which is flammable and explosive. To reduce the risk of death or serious injury, take the following precautions while working on or near the 12-volt battery:

- Do not cause sparks by touching the 12-volt battery terminals with tools.
- Do not smoke or light a match near the 12-volt battery.
- Avoid contact with eyes, skin and clothes.
- Never inhale or swallow electrolyte.
- Wear protective safety glasses when working near the 12-volt battery.
- Keep children away from the 12-volt battery.

■ Where to safely charge the 12-volt battery

Always charge the 12-volt battery in an open area. Do not charge the 12-volt battery in a garage or closed room where there is insufficient ventilation.

■ How to recharge the 12-volt battery

Recharge at a current of 5 A or less and make sure that the recharging period does not exceed a total of 12 hours.

■ Emergency measures regarding electrolyte

- If electrolyte gets in your eyes
Flush your eyes with clean water for at least 15 minutes and get immediate medical attention. If possible, continue to apply water with a sponge or cloth while traveling to the nearest medical facility.
- If electrolyte gets on your skin
Wash the affected area thoroughly. If you feel pain or burning, get medical attention immediately.
- If electrolyte gets on your clothes
It can soak through clothing on to your skin. Immediately take off the clothing and follow the procedure above if necessary.
- If you accidentally swallow electrolyte
Drink a large quantity of water or milk. Get emergency medical attention immediately.

■ When replacing the 12-volt battery

Use a 12-volt battery designed for this vehicle. Failure to do so may cause gas (hydrogen) to enter the passenger compartment, causing a fire or explosion.

For replacement of the 12-volt battery, contact any authorized Lexus retailer or Lexus authorized repairer, or any reliable repairer.

**NOTICE****■ When recharging the 12-volt battery**

Never recharge the 12-volt battery while the hybrid system is operating. Also, be sure all accessories are turned off.

Tires

Replace or rotate tires in accordance with maintenance schedules and treadwear.

Checking tires

Check if the treadwear indicators are showing on the tires. Also check the tires for uneven wear, such as excessive wear on one side of the tread.

Check the spare tire condition and pressure if not rotated.

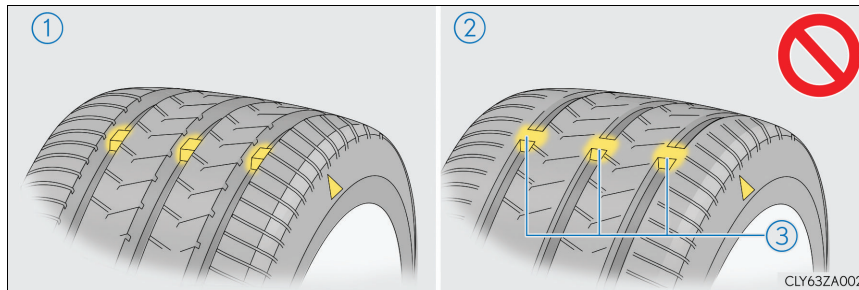

- ① New tread
- ② Worn tread
- ③ Treadwear indicator

The location of treadwear indicators is shown by the "TWI" or "Δ" mark, etc., molded into the sidewall of each tire.

Replace the tires if the treadwear indicators are showing on a tire.

Tire rotation

Rotate the tires in the order shown.

- ▶ Vehicles with front and rear tires of the same size
- ▶ Vehicles with front and rear tires of differing sizes

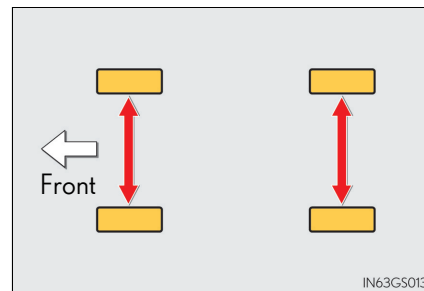
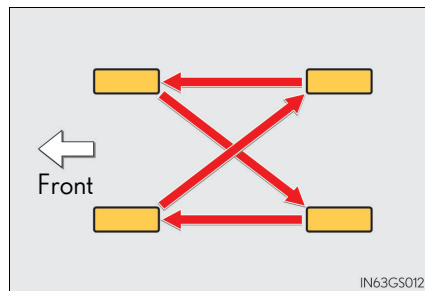

To equalize tire wear and help extend tire life, Lexus recommends that tire rotation is carried out approximately every 10000 km (6000 miles).

Do not fail to initialize the tire pressure warning system after tire rotation. (vehicle with the tire pressure warning system)

Tire pressure warning system (if equipped)

Your vehicle is equipped with a tire pressure warning system that uses tire pressure warning valves and transmitters to detect low tire inflation pressure before serious problems arise.

- ▶ Vehicles without the tire inflation pressure display function

If the tire pressure drops below a predetermined level, the driver is warned by a warning light. (→P. 463)

- ▶ Vehicles with the tire inflation pressure display function

- If the tire pressure drops below a predetermined level, the driver is warned by the multi-information display and a warning light. (→P. 460, 466)

- The tire pressure detected by the tire pressure warning system can be displayed on the multi-information display. (→P. 111)

The illustration used is intended as an example, and may differ from the image that is actually displayed on the multi-information display.

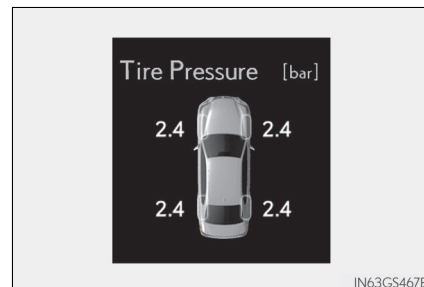

◆ **Installing tire pressure warning valves and transmitters**

When replacing tires or wheels, tire pressure warning valves and transmitters must also be installed.

When new tire pressure warning valves and transmitters are installed, new ID codes must be registered in the tire pressure warning computer and the tire pressure warning system must be initialized. Have tire pressure warning valve and transmitter ID codes registered by any authorized Lexus retailer or Lexus authorized repairer, or any reliable repairer. (→P. 419)







◆ **Initializing the tire pressure warning system**



■ **The tire pressure warning system must be initialized in the following circumstances:**

- When rotating the tires.
- When the tire inflation pressure is changed such as when changing traveling speed.

When the tire pressure warning system is initialized, the current tire inflation pressure is set as the benchmark pressure.

■ **How to initialize the tire pressure warning system**

- 1 Park the vehicle in a safe place and turn the power switch off.
Initialization cannot be performed while the vehicle is moving.
- 2 Adjust the tire inflation pressure to the specified cold tire inflation pressure level. (→P. 555)
Make sure to adjust the tire pressure to the specified cold tire inflation pressure level. The tire pressure warning system will operate based on this pressure level.
- 3 Turn the power switch to ON mode.
- 4 Press  or  on the meter control switch and select .
- 5 Press  or  on the meter control switch and select "Vehicle Settings".
Then press .

- 6 Press  or  on the meter control switch and select "TPMS". Then press and hold  until a message is displayed.

The message will be displayed on the multi-information display and the tire pressure warning light will blink slowly 3 times.

When the message disappears, initialization is complete.



◆ Registering ID codes

The tire pressure warning valve and transmitter is equipped with a unique ID code. When replacing a tire pressure warning valve and transmitter, it is necessary to register the ID code. Have the ID code registered by any authorized Lexus retailer or Lexus authorized repairer, or any reliable repairer.

■ When to replace your vehicle's tires

Tires should be replaced if:

- The treadwear indicators are showing on a tire.
- You have tire damage such as cuts, splits, cracks deep enough to expose the fabric, and bulges indicating internal damage
- A tire goes flat repeatedly or cannot be properly repaired due to the size or location of a cut or other damage

If you are not sure, consult with any authorized Lexus retailer or Lexus authorized repairer, or any reliable repairer.

■ Replacing tires and wheels (vehicles with the tire pressure warning system)

If the ID code of the tire pressure warning valve and transmitter is not registered, the tire pressure warning system will not work properly. After driving for about 10 minutes, the tire pressure warning light blinks for 1 minute and stays on to indicate a system malfunction.

■ Tire life

Any tire over 6 years old must be checked by a qualified technician even if it has seldom or never been used or damage is not obvious.

■ Routine tire inflation pressure checks

The tire pressure warning system does not replace routine tire inflation pressure checks. Make sure to check tire inflation pressure as part of your routine of daily vehicle checks.

■ When rotating the tires (vehicles with the tire pressure warning system featuring a tire inflation pressure display function)

Make sure that the power switch is off. If the tires are rotated while the power switch is in ON mode, the tire position information will not be updated.

If this accidentally occurs, either turn the power switch to off and then to ON mode, or initialize the system after checking that the tire pressure is properly adjusted.

■ Low profile tires (except 225/50R17 tires)

Generally, low profile tires will wear more rapidly and tire grip performance will be reduced on snowy and/or icy roads when compared to standard tires. Be sure to use snow tires or tire chains on snowy and/or icy roads and drive carefully at a speed appropriate for road and weather conditions. (→P. 336)

■ If the tread on snow tires wears down below 4 mm (0.16 in.)

The effectiveness of the tires as snow tires is lost.

■ Situations in which the tire pressure warning system may not operate properly (vehicles with the tire pressure warning system)**● In the following cases, the tire pressure warning system may not operate properly.**

- If non-genuine Lexus wheels are used.
- A tire has been replaced with a tire that is not an OE (Original Equipment) tire.
- A tire has been replaced with a tire that is not of the specified size.
- Tire chains etc. are equipped.
- An auxiliary-supported run-flat tire is equipped.
- If a window tint that affects the radio wave signals is installed.
- If there is a lot of snow or ice on the vehicle, particularly around the wheels or wheel housings.
- If the tire inflation pressure is extremely higher than the specified level.
- If wheel without the tire pressure warning valve and transmitter are used.
- If the ID code on the tire pressure warning valves and transmitters is not registered in the tire pressure warning computer.

● Performance may be affected in the following situations.

- Near a TV tower, electric power plant, gas station, radio station, large display, airport or other facility that generates strong radio waves or electrical noise
- When carrying a portable radio, cellular phone, cordless phone or other wireless communication device

Vehicles with the tire inflation pressure display function: If tire position information is not correctly displayed due to the radio wave conditions, the display may be corrected by driving and changing the radio wave conditions.

- When the vehicle is parked, the time taken for the warning to start or go off could be extended.
- When tire inflation pressure declines rapidly for example when a tire has burst, the warning may not function.

■ **The initialization operation (vehicles with the tire pressure warning system)**

- Make sure to carry out initialization after adjusting the tire inflation pressure. Also, make sure the tires are cold before carrying out initialization or tire inflation pressure adjustment.
- If you have accidentally turned the power switch off during initialization, it is not necessary to manually restart the initialization again, as initialization will restart automatically the next time the power switch is turned to ON mode.
- If you accidentally perform initialization when initialization is not necessary, adjust the tire inflation pressure to the specified level when the tires are cold, and conduct initialization again.

■ **Warning performance of the tire pressure warning system (if equipped)**

The warning of the tire pressure warning system will change in accordance with the conditions under which it was initialized. For this reason, the system may give a warning even if the tire pressure does not reach a low enough level, or if the pressure is higher than the pressure that was adjusted to when the system was initialized.

■ **When initialization of the tire pressure warning system has failed (vehicles with the tire pressure warning system)**

Initialization can be completed in a few minutes. However, in the following cases, the settings have not been recorded and the system will not operate properly. If repeated attempts to record tire inflation pressure settings are unsuccessful, have the vehicle inspected by any authorized Lexus retailer or Lexus authorized repairer, or any reliable repairer.

- The initialization message is not displayed on the multi-information display when performing initialization.
- After carrying out the initialization procedure, the tire pressure warning light blinks for 1 minute then stays on after driving for 20 minutes.

■ **Registering ID codes (vehicles with the tire pressure warning system)**

The ID codes of the tire pressure warning valve and transmitters for two sets of wheels can be registered.

It is not necessary to register the ID codes when replacing normal tires with snow tires, if the ID codes for the wheels of both normal tires and snow tires are registered beforehand.

For information about changing ID codes, ask any authorized Lexus retailer or Lexus authorized repairer, or any reliable repairer.

■ **Certification for tire pressure warning system (vehicles with the tire pressure warning system)**

The latest "DECLARATION of CONFORMITY "(DoC) is available at the following:DoC address :

<http://www.pacific-ind.co.jp/eng/products/car/tpms/doc/>

CE 0891

<p>Hereby, PACIFIC INDUSTRIAL CO.,LTD., declares that this PMV-C210 is in compliance with the essential requirements and other relevant provisions of Directive 1999/5/EC.</p>
<p>PACIFIC INDUSTRIAL CO.,LTD. vakuuttaa täten että PMV-C210 tyyppinen laite on direktiivin 1999/5/EY oleellisten vaatimusten ja sitä koskevien direktiivin muiden ehtojen mukainen.</p>
<p>Hierbij verklaart PACIFIC INDUSTRIAL CO.,LTD. dat het toestel PMV-C210 in overeenstemming is met de essentiële eisen en de andere relevante bepalingen van richtlijn 1999/5/EG.</p>
<p>Par la présente PACIFIC INDUSTRIAL CO.,LTD. déclare que l'appareil PMV-C210 est conforme aux exigences essentielles et aux autres dispositions pertinentes de la directive 1999/5/CE.</p>
<p>Härmed intygar PACIFIC INDUSTRIAL CO.,LTD. att denna PMV-C210 står i överensstämmelse med de väsentliga egenskapskrav och övriga relevanta bestämmelser som framgår av direktiv 1999/5/EG</p>
<p>Undertegnede PACIFIC INDUSTRIAL CO.,LTD. erklærer herved, at følgende udstyr PMV-C210 overholder de væsentlige krav og øvrige relevante krav i direktiv 1999/5/EF.</p>
<p>Hiermit erkläre PACIFIC INDUSTRIAL CO.,LTD., dass sich das Gerät PMV-C210 in Übereinstimmung mit den grundlegenden Anforderungen und den übrigen einschlägigen Bestimmungen der Richtlinie 1999/5/EG befindet.</p>
<p>ΜΕ ΤΗΝ ΠΑΡΟΥΣΑ ΠΑΚΙΦΙΚΗ ΙΝΔΥΣΤΡΙΑΛ ΚΟ.,ΛΤΔ. ΔΗΛΩΝΕΙ ΟΤΙ Η ΜΗΧΑΝΗΤΗΡΑ PMV-C210 ΣΥΜΜΟΡΦΩΝΕΤΑΙ ΠΡΟΣ ΤΙΣ ΟΥΣΙΩΔΕΙΣ ΑΠΑΙΤΗΣΕΙΣ ΚΑΙ ΤΙΣ ΛΟΙΠΕΣ ΣΧΕΤΙΚΕΣ ΔΙΑΤΑΞΕΙΣ ΤΗΣ ΟΔΗΓΙΑΣ 1999/5/ΕΚ.</p>
<p>Con la presente PACIFIC INDUSTRIAL CO.,LTD. dichiara che questo PMV-C210 è conforme ai requisiti essenziali ed alle altre disposizioni pertinenti stabilite dalla direttiva 1999/5/CE.</p>
<p>Por medio de la presente PACIFIC INDUSTRIAL CO.,LTD. declara que el PMV-C210 cumple con los requisitos esenciales y cualesquiera otras disposiciones aplicables o exigibles de la Directiva 1999/5/CE.</p>
<p>PACIFIC INDUSTRIAL CO.,LTD. declara que este PMV-C210 está conforme com os requisitos essenciais e outras disposições da Directiva 1999/5/CE.</p>
<p>Hawnhekk, PACIFIC INDUSTRIAL CO.,LTD., jiddikjara li dan PMV-C210 jikkonforma mal-ftigġiet essenzjali u ma provvedimenti oħrajn rilevanti li hemm fid-Dirrettiva 1999/5/EC.</p>
<p>Käesolevaga kinnitab PACIFIC INDUSTRIAL CO.,LTD. seadme PMV-C210 vastavust direktiivi 1999/5/EÜ põhinõuetele ja nimetatud direktiivist tulenevatele teistele asjakohastele sätetele.</p>
<p>Alulírott, PACIFIC INDUSTRIAL CO.,LTD. nyilatkozom, hogy a PMV-C210 megfelel a vonatkozó alapvető követelményeknek és az 1999/5/EC irányelv egyéb előírásainak.</p>

PACIFIC INDUSTRIAL CO.,LTD. tímto vyhlasuje, že PMV-C210 splňa základné požiadavky a všetky príslušné ustanovenia Smernice 1999/5/ES.
PACIFIC INDUSTRIAL CO.,LTD. tímto prohlašuje, že tento PMV-C210 je ve shodě se základními požadavky a dalšími příslušnými ustanoveními směrnice 1999/5/ES.
PACIFIC INDUSTRIAL CO.,LTD. izjavlja, da je ta PMV-C210 v skladu z bistvenimi zahtevami in ostalimi relevantnimi določili direktive 1999/5/ES.
Šiuo PACIFIC INDUSTRIAL CO.,LTD. deklaruoja, kad šis PMV-C210 atitinka esminius reikalavimus ir kitas 1999/5/EB Direktyvos nuostatas.
Ar šo PACIFIC INDUSTRIAL CO.,LTD. deklarē, ka PMV-C210 atbilst Direktīvas 1999/5/EK būtiskajām prasībām un citiem ar to saistītajiem noteikumiem.
Niniejszym PACIFIC INDUSTRIAL CO.,LTD. oświadcza, że PMV-C210 jest zgodny z zasadniczymi wymogami oraz pozostałymi stosownymi postanowieniami Dyrektywy 1999/5/EC.
Hér með lýsir PACIFIC INDUSTRIAL CO.,LTD. yfir því að PMV-C210 er í samræmi við grunnkröfur og aðrar kröfur, sem gerðar eru í tilskipun 1999/5/EC.
PACIFIC INDUSTRIAL CO.,LTD. erklærer herved at utstyret PMV-C210 er i samsvar med de grunnleggende krav og øvrige relevante krav i direktiv 1999/5/EF.
С настояще то, PACIFIC INDUSTRIAL CO.,LTD., декларира, че PMV-C210 е в съответствие със съществените изисквания и другите приложими разпоредби на Директива 1999/5/ЕС.
Prin prezenta, PACIFIC INDUSTRIAL CO.,LTD., declară că aparatul PMV-C210 este în conformitate cu cerințele esențiale și cu alte prevederi pertinente ale Directivei 1999/5/CE.
Ovim , PACIFIC INDUSTRIAL CO.,LTD., izjavlja da ovaj PMV-C210 je usklađen sa bitnim zahtjevima i drugim relevantnim odredbama Direktive 1999/5/EC.
Ovim, PACIFIC INDUSTRIAL CO.,LTD., deklarirše da je PMV-C210 u skladu sa osnovnim zahtjevima i ostalim relevantnim odredbama Direktive 1999/5/EC.
Ovim PACIFIC INDUSTRIAL CO.,LTD., izjavlja da je PMV-C210 u skladu sa bitnim zahtjevima i drugim relevantnim odredbama Direktive 1999/5/EC.
Me ané tē kēsaj, PACIFIC INDUSTRIAL CO, LTD., Deklaron se ky PMV-C210 ēshtë nē pārputhje me kērkēsat themelore dhe dispozitat e tjera pārkatēse tē direktīvēs 1999/5/EC.

 The latest "DECLARATION of CONFORMITY" (DoC) is available at the following address:
<http://www.globaldenso.com/en/products/oem/index.html>

Hereby, DENSO CORPORATION declares that this 22AAA is in compliance with the essential requirements and other relevant provisions of Directive 1999/5/EC.
DENSO CORPORATION vakuuttaa täten että 22AAA tyyppinen laite on direktiivin 1999/5/EY oleellisten vaatimusten ja sitä koskevien direktiivin muiden ehtojen mukainen.
Hierbij verklaart DENSO CORPORATION dat het toestel 22AAA in overeenstemming is met de essentiële eisen en de andere relevante bepalingen van richtlijn 1999/5/EG.
Par la présente DENSO CORPORATION déclare que l'appareil 22AAA est conforme aux exigences essentielles et aux autres dispositions pertinentes de la directive 1999/5/CE.
Härmed intygar DENSO CORPORATION att denna 22AAA står i överensstämmelse med de väsentliga egenskapskrav och övriga relevanta bestämmelser som framgår av direktiv 1999/5/EG.
Undertegnede DENSO CORPORATION erklærer herved, at følgende udstyr 22AAA overholder de væsentlige krav og øvrige relevante krav i direktiv 1999/5/EF.
Hiermit erklärt DENSO CORPORATION, dass sich das Gerät 22AAA in Übereinstimmung mit den grundlegenden Anforderungen und den übrigen einschlägigen Bestimmungen der Richtlinie 1999/5/EG befindet.
ΜΕ ΤΗΝ ΠΑΡΟΥΣΑ DENSO CORPORATION ΔΗΛΩΝΕΙ ΟΤΙ 22ΑΑΑ ΣΥΜΜΟΡΦΩΝΕΤΑΙ ΠΡΟΣ ΤΙΣ ΟΥΣΙΩΔΕΙΣ ΑΠΑΙΤΗΣΕΙΣ ΚΑΙ ΤΙΣ ΛΟΙΠΕΣ ΣΧΕΤΙΚΕΣ ΔΙΑΤΑΞΕΙΣ ΤΗΣ ΟΔΗΓΙΑΣ 1999/5/ΕΚ.
Con la presente DENSO CORPORATION dichiara che questo 22AAA è conforme ai requisiti essenziali ed alle altre disposizioni pertinenti stabilite dalla direttiva 1999/5/CE.
Por medio de la presente DENSO CORPORATION declara que el 22AAA cumple con los requisitos esenciales y cualesquiera otras disposiciones aplicables o exigibles de la Directiva 1999/5/CE.
DENSO CORPORATION declara que este 22AAA está conforme com os requisitos essenciais e outras disposições da Directiva 1999/5/CE.
Hawnhekk, DENSO CORPORATION, jiddikjara li dan 22AAA jikkonforma mal-ħtigijiet essenzjali u ma provvedimenti oħrajn relevanti li hemm fid-Dirrettiva 1999/5/EC.
Käesolevaga kinnitab DENSO CORPORATION seadme 22AAA vastavust direktiivi 1999/5/EÜ põhinõuetele ja nimetatud direktiivist tulenevatele teistele asjakohastele sätetele.
Alulírott, DENSO CORPORATION nyilatkozom, hogy a 22AAA megfelel a vonatkozó alapvető követelményeknek és az 1999/5/EC irányelv egyéb előírásainak.

DENSO CORPORATION tímto vyhlasuje, že 22AAA spĺňa základné požiadavky a všetky príslušné ustanovenia Smernice 1999/5/ES.
DENSO CORPORATION tímto prohlašuje, že tento 22AAA je ve shodě se základními požadavky a dalšími příslušnými ustanoveními směrnice 1999/5/ES.
DENSO CORPORATION izjavlja, da je ta 22AAA v skladu z bistvenimi zahtevami in ostalimi relevantnimi določili direktive 1999/5/ES.
Šiuo DENSO CORPORATION deklaruoja, kad šis 22AAA atitinka esminius reikalavimus ir kitas 1999/5/EB Direktyvos nuostatas.
Ar šo DENSO CORPORATION deklarē, ka 22AAA atbilst Direktīvas 1999/5/EK būtiskajām prasībām un citiem ar to saistītajiem noteikumiem.
Niniejszym DENSO CORPORATION oświadcza, że 22AAA jest zgodny z zasadniczymi wymogami oraz pozostałymi stosownymi postanowieniami Dyrektywy 1999/5/EC.
Hér með lýsir DENSO CORPORATION yfir því að 22AAA er í samræmi við grunnkröfur og aðrar kröfur, sem gerðar eru í tilskipun 1999/5/EC.
DENSO CORPORATION erklærer herved at utstyret 22AAA er i samsvar med de grundlæggende krav og øvrige relevante krav i direktiv 1999/5/EF.
С настоящето, DENSO CORPORATION, декларира, че 22AAA е в съответствие със съществените изисквания и другите приложими разпоредби на Директива 1999/5/EC.
Prin prezenta, DENSO CORPORATION, declară că aparatul 22AAA este în conformitate cu cerințele esențiale și cu alte prevederi pertinente ale Directivei 1999/5/CE.
Ovim, DENSO CORPORATION, izjavljuje da ovaj 22AAA je usklađen sa bitnim zahtjevima i drugim relevantnim odredbama Direktive 1999/5/EC.
Ovim, DENSO CORPORATION, deklarirše da je 22AAA u skladu sa osnovnim zahtevima i ostalim relevantnim odredbama Direktive 1999/5/EC.
Ovim DENSO CORPORATION, izjavljuje da je 22AAA u skladu s bitnim zahtjevima i drugim relevantnim odredbama Direktive 1999/5/EC i Pravilnika o RiTT opremi (NN 25/2012).
Nepermjet kesaj, DENSO CORPORATION, deklaroi qe ky 22AAA eshte ne pajtim me kerkesat thelbesore dhe dispozitat e tjera perkatese te Direktives 1999/5/EC.

⚠ WARNING**■ When inspecting or replacing tires**

Observe the following precautions to prevent accidents.

Failure to do so may cause damage to parts of the drive train as well as dangerous handling characteristics, which may lead to an accident resulting in death or serious injury.

- Do not mix tires of different makes, models or tread patterns.
Also, do not mix tires of remarkably different treadwear.
- Do not use tire sizes other than those recommended by Lexus.
- Do not mix differently constructed tires (radial, bias-belted or bias-ply tires).
- Do not mix summer, all season and snow tires.
- Do not use tires that have been used on another vehicle.
Do not use tires if you do not know how they were used previously.
- Vehicles with compact spare tire: Do not tow if your vehicle has a compact spare tire installed.
- Vehicles with emergency tire puncture repair kit: Do not tow anything if a tire that has been repaired using the emergency tire puncture repair kit is installed. The load on the tire may cause unexpected damage to the tire.

■ When initializing the tire pressure warning system (vehicles with the tire pressure warning system)

Do not initialize tire inflation pressure without first adjusting the tire inflation pressure to the specified level. Otherwise, the tire pressure warning light may not come on even if the tire inflation pressure is low, or it may come on when the tire inflation pressure is actually normal.

■ Caution regarding interference with electronic devices (vehicles with the tire pressure warning system featuring a tire inflation pressure display function)

- People with implantable cardiac pacemakers, cardiac resynchronization therapy-pacemakers or implantable cardioverter defibrillators should not come within 450 mm (17.7 in.) of the tire pressure warning system initiators. The radio waves may affect the operation of such devices.

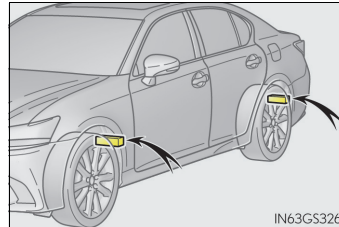

- Users of any electrical medical device other than implantable cardiac pacemakers, cardiac resynchronization therapy-pacemakers or implantable cardioverter defibrillators should consult the manufacturer of the device for information about its operation under the influence of radio waves.
Radio waves could have unexpected effects on the operation of such medical devices.

 NOTICE

■ **Repairing or replacing tires, wheels, tire pressure warning valves, transmitters and tire valve caps (vehicles with the tire pressure warning system)**

- When removing or fitting the wheels, tires or the tire pressure warning valves and transmitters, contact any authorized Lexus retailer or Lexus authorized repairer, or any reliable repairer as the tire pressure warning valves and transmitters may be damaged if not handled correctly.
- Make sure to install the tire valve caps. If the tire valve caps are not installed, water could enter the tire pressure warning valves and the tire pressure warning valves could be bound.
- When replacing tire valve caps, do not use tire valve caps other than those specified. The cap may become stuck.

■ **To avoid damage to the tire pressure warning valves and transmitters (vehicles with the tire pressure warning system)**

When a tire is repaired with liquid sealants, the tire pressure warning valve and transmitter may not operate properly. If a liquid sealant is used, contact any authorized Lexus retailer or Lexus authorized repairer, or any reliable repairer or other qualified service shop as soon as possible. After use of liquid sealant, make sure to replace the tire pressure warning valve and transmitter when repairing or replacing the tire.
(→P. 418)

■ **Driving on rough roads**

Take particular care when driving on roads with loose surfaces or potholes. These conditions may cause losses in tire inflation pressure, reducing the cushioning ability of the tires. In addition, driving on rough roads may cause damage to the tires themselves, as well as the vehicle's wheels and body.

■ **Low profile tires (except 225/50R17 tires)**

Low profile tires may cause greater damage than usual to the tire wheel when sustaining impact from the road surface. Therefore, pay attention to the following:

- Be sure to use proper tire inflation pressure. If tires are under-inflated, they may be damaged more severely.
- Avoid potholes, uneven pavement, curbs and other road hazards. Failure to do so may lead to severe tire and wheel damage.

■ **If tire inflation pressure of each tire becomes low while driving**

Do not continue driving, or your tires and/or wheels may be ruined.

Tire inflation pressure

Make sure to maintain proper tire inflation pressure. Tire inflation pressure should be checked at least once per month. However, Lexus recommends that tire inflation pressure be checked once every two weeks. (→P. 555)

■ Effects of incorrect tire inflation pressure

Driving with incorrect tire inflation pressure may result in the following:

- Reduced fuel economy
- Reduced driving comfort and poor handling
- Reduced tire life due to wear
- Reduced safety
- Damage to the drive train

If a tire needs frequent inflating, have it checked by any authorized Lexus retailer or Lexus authorized repairer, or any reliable repairer.

■ Instructions for checking tire inflation pressure

When checking tire inflation pressure, observe the following:

- Check only when the tires are cold.
If your vehicle has been parked for at least 3 hours or has not been driven for more than 1.5 km or 1 mile, you will get an accurate cold tire inflation pressure reading.
- Always use a tire pressure gauge.
It is difficult to judge if a tire is properly inflated based only on its appearance.
- It is normal for the tire inflation pressure to be higher after driving as heat is generated in the tire. Do not reduce tire inflation pressure after driving.
- Passengers and luggage weight should be placed so that the vehicle is balanced.

WARNING

■ Proper inflation is critical to save tire performance

Keep your tires properly inflated.

If the tires are not properly inflated, the following conditions may occur which could lead to an accident resulting in death or serious injury:

- Excessive wear
- Uneven wear
- Poor handling
- Possibility of blowouts resulting from overheated tires
- Air leaking from between tire and wheel
- Wheel deformation and/or tire damage
- Greater possibility of tire damage while driving (due to road hazards, expansion joints, sharp edges in the road, etc.)



NOTICE

■ **When inspecting and adjusting tire inflation pressure**

Be sure to put the tire valve caps back on.

If a valve cap is not installed, dirt or moisture may get into the valve and cause an air leak, resulting in decreased tire inflation pressure.

Wheels

If a wheel is bent, cracked or heavily corroded, it should be replaced. Otherwise, the tire may separate from the wheel or cause a loss of handling control.

Wheel selection

When replacing wheels, care should be taken to ensure that they are equivalent to those removed in load capacity, diameter, rim width and inset*.

Replacement wheels are available at any authorized Lexus retailer or Lexus authorized repairer, or any reliable repairer.

*: Conventionally referred to as "offset".

Lexus does not recommend using the following:

- Wheels of different sizes or types
- Used wheels
- Bent wheels that have been straightened
- Steel wheels (except for vehicles with steel spare wheel)

Aluminum wheel precautions

- Use only Lexus wheel nuts and wrenches designed for use with your aluminum wheels.
- When rotating, repairing or changing your tires, check that the wheel nuts are still tight after driving 1600 km (1000 miles).
- Be careful not to damage the aluminum wheels when using tire chains.
- Use only Lexus genuine balance weights or equivalent and a plastic or rubber hammer when balancing your wheels.

■ When replacing wheels (vehicles with the tire pressure warning system)

The wheels of your vehicle are equipped with tire pressure warning valves and transmitters that allow the tire pressure warning system to provide advance warning in the event of a loss in tire inflation pressure. Whenever wheels are replaced, tire pressure warning valves and transmitters must be installed. (→P. 418)

 **WARNING****■ When replacing wheels**

- Do not use wheels that are a different size from those recommended in the Owner's Manual, as this may result in a loss of handling control.
- Never use an inner tube in a leaking wheel which is designed for a tubeless tire. Doing so may result in an accident, causing death or serious injury.
- Except for vehicles with steel spare wheel: Do not install steel wheels. The wheel contact surface could be damaged, and the wheel could come off while driving, which could lead to an accident resulting in death or serious injury. (except for vehicles with steel spare wheel)

■ Use of defective wheels prohibited

Do not use cracked or deformed wheels.
Doing so could cause the tire to leak air during driving, possibly causing an accident.

 **NOTICE****■ Replacing tire pressure warning valves and transmitters (vehicles with the tire pressure warning system)**

- Because tire repair or replacement may affect the tire pressure warning valves and transmitters, make sure to have tires serviced by any authorized Lexus retailer or Lexus authorized repairer, or any reliable repairer or other qualified service shop. In addition, make sure to purchase your tire pressure warning valves and transmitters at any authorized Lexus retailer or Lexus authorized repairer, or any reliable repairer.
- Ensure that only genuine Lexus wheels are used on your vehicle. Tire pressure warning valves and transmitters may not work properly with non-genuine wheels.

Air conditioning filter

The air conditioning filter must be changed regularly to maintain air conditioning efficiency.

Removal method

- 1 Turn the power switch off.
- 2 Open the glove box. Lift up the side with the stay, disconnect the stay tabs and remove the partition by pulling horizontally.
- 3 Press the tabs and remove the filter cover.
- 4 Press the tabs and remove the filter case.

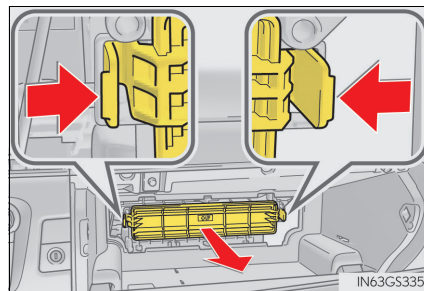
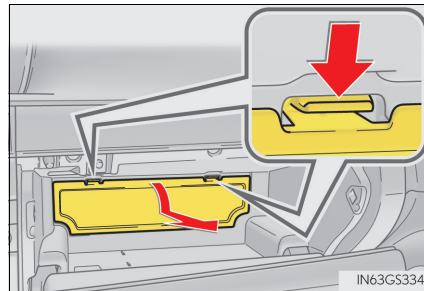
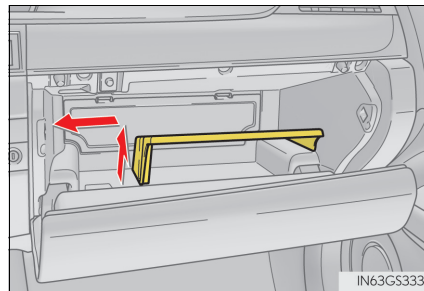

- 5 Remove the air conditioning filter from the filter case and replace it with a new one.

The “↑UP” marks shown on the filter and the filter case should be pointing up.

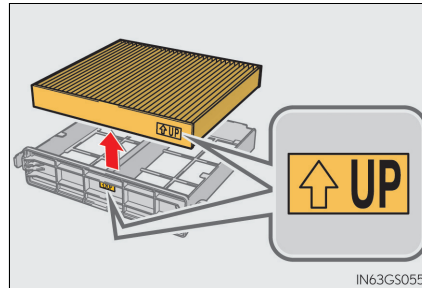

■ **Changing interval**

Inspect and replace the air conditioning filter according to the maintenance schedule. In dusty areas or areas with heavy traffic flow, early replacement may be required. (For scheduled maintenance information, please refer to the “Lexus Service Booklet” or “Lexus Warranty Booklet”.)

■ **If air flow from the vents decreases dramatically**

The filter may be clogged. Check the filter and replace if necessary.

■ **Air conditioning filter with deodorizing function**

When fragrances are placed in your vehicle, the deodorizing effect may become significantly weakened in a short period.

When an air conditioning odor comes out continuously, replace the air conditioning filter.

 **NOTICE**

■ **When using the air conditioning system**

When fragrances are placed in your vehicle, the deodorizing effect may become significantly weakened in a short period.

When an air conditioning odor comes out continuously, replace the air conditioning filter.

Electronic key battery

Replace the battery with a new one if it is depleted.

You will need the following items:

- Flathead screwdriver
- Small flathead screwdriver
- Lithium battery CR2032

Replacing the battery

- 1 Take out the mechanical key.

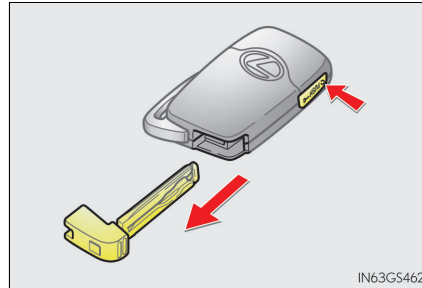

- 2 Remove the cover.

To prevent damage to the key, cover the tip of the screwdriver with a rag.

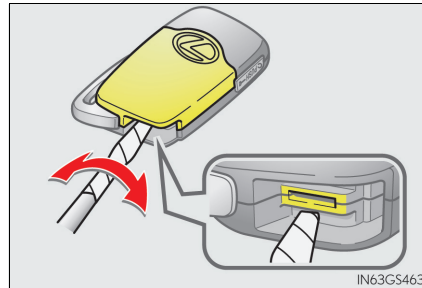

- 3 Remove the battery cover.

To prevent damage to the key, cover the tip of the screwdriver with a rag.

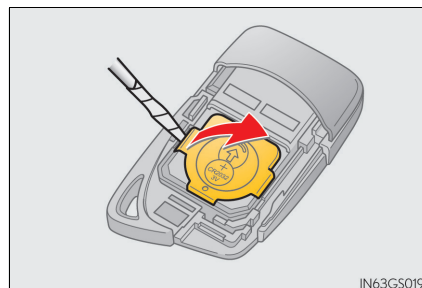

- 4 Remove the depleted battery.
Insert a new battery with the "+" terminal facing up.

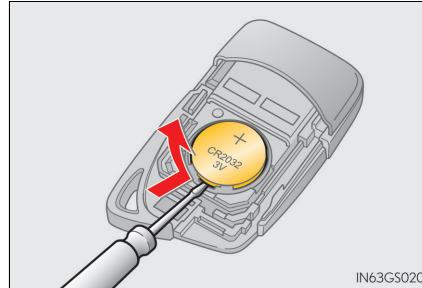

■ **Use a CR2032 lithium battery**

- Batteries can be purchased at any authorized Lexus retailer or Lexus authorized repairer, or any reliable repairer, local electrical appliance shops or camera stores.
- Replace only with the same or equivalent type recommended by the manufacturer.
- Dispose of used batteries according to the local laws.

■ **When the card key battery needs to be replaced (if equipped)**

The battery for the card key is available only at Lexus dealers. Your Lexus dealer can replace the battery for you.

■ **If the electronic key battery is depleted**

The following symptoms may occur:

- The smart entry & start system and wireless remote control will not function properly.
- The operational range will be reduced.

⚠ WARNING

■ **Removed battery and other parts**

These parts are small and if swallowed by a child, they can cause choking. Keep away from children. Failure to do so could result in death or serious injury.

■ **Lithium battery precautions**

CAUTION
RISK OF EXPLOSION IF BATTERY IS REPLACED BY AN INCORRECT TYPE.
DISPOSE OF USED BATTERIES ACCORDING TO THE INSTRUCTIONS

⚠ NOTICE

■ **For normal operation after replacing the battery**

Observe the following precautions to prevent accidents:

- Always work with dry hands.
Moisture may cause the battery to rust.
- Do not touch or move any other component inside the remote control.
- Do not bend either of the battery terminals.

Checking and replacing fuses

If any of the electrical components do not operate, a fuse may have blown. If this happens, check and replace the fuses as necessary.

- 1 Turn the power switch off.
- 2 Open the fuse box cover.
 - ▶ Engine compartment:

Remove the engine compartment cover (→P. 405) and remove all of the clips.

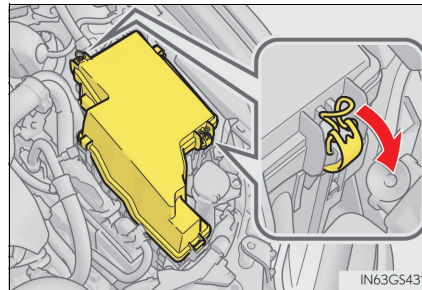

Push the tabs on either side to detach the lock and lift the lid off while pulling the lock plate.

When installing the lid, check that the lock plate and the tabs on either side are connected correctly.

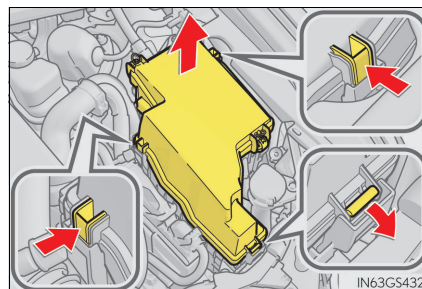

438 6-3. Do-it-yourself maintenance

- ▶ Left side instrument panel (left-hand drive vehicles)

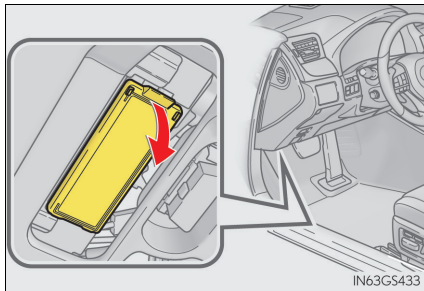

Remove the lid.

- ▶ Left side instrument panel (right-hand drive vehicles)

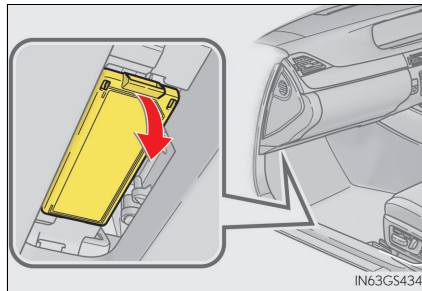

Remove the lid.

- ▶ Right side instrument panel (left-hand drive vehicles)

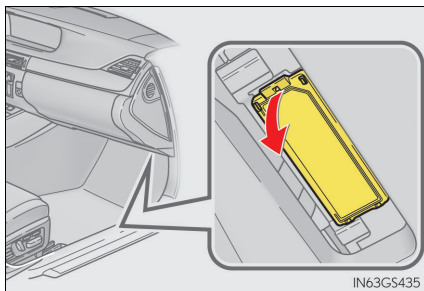

Remove the lid.

- ▶ Right side instrument panel (right-hand drive vehicles)

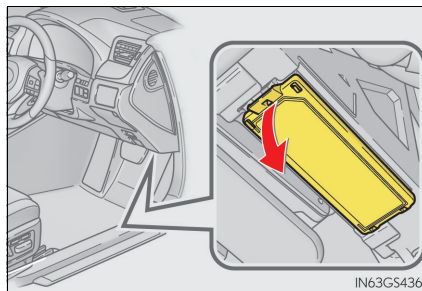

Remove the lid.

► Trunk

Push the tab in and lift the lid off.

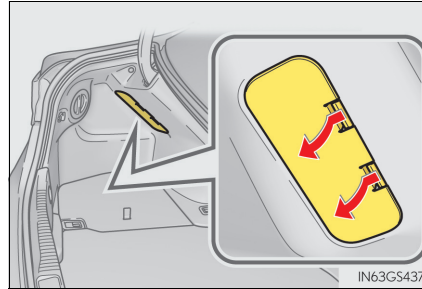

Remove the lid.

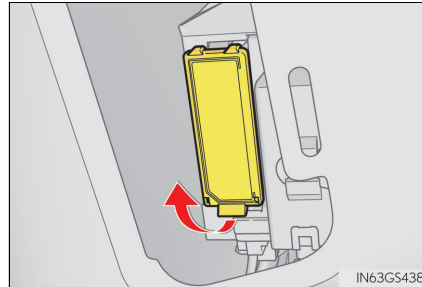

► The upper part of the 12-volt battery

Pull the strap upwards to lift up the 12-volt battery cover.

When one or more of the fuses in this unit are blown, the unit needs to be replaced as a whole.

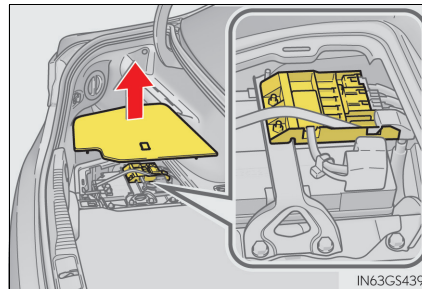

3 Remove the fuse with the pullout tool.

Only type A fuse can be removed using the pullout tool.

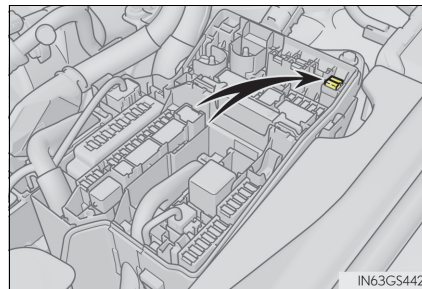

4 Check if the fuse is blown.

- ① Normal fuse
- ② Blown fuse

Type A and B:

Replace the blown fuse with a new fuse of an appropriate amperage rating. The amperage rating can be found on the fuse box lid.

Type C and D:

Contact any authorized Lexus retailer or Lexus authorized repairer, or any reliable repairer.

► Type A

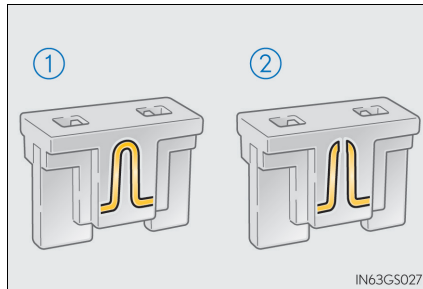

► Type B

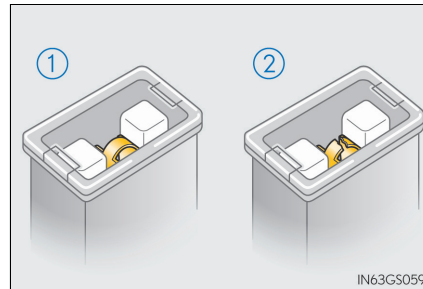

► Type C

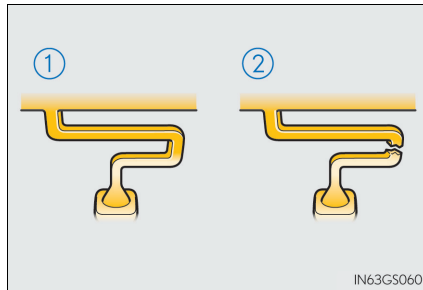

► Type D

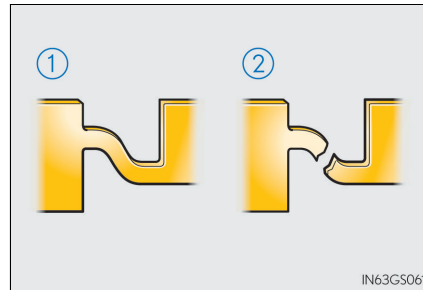

■ **After a fuse is replaced**

- If the lights do not turn on even after the fuse has been replaced, a bulb may need replacement. (→P. 442)
- If the replaced fuse blows again, have the vehicle inspected by any authorized Lexus retailer or Lexus authorized repairer, or any reliable repairer.

■ **If there is an overload in a circuit**

The fuses are designed to blow, protecting the wiring harness from damage.

■ **When replacing light bulbs**

Lexus recommends that you use genuine Lexus products designed for this vehicle. Because certain bulbs are connected to circuits designed to prevent overload, non-genuine parts or parts not designed for this vehicle may be unusable.

 **WARNING**

■ **To prevent system breakdowns and vehicle fire**

Observe the following precautions.

Failure to do so may cause damage to the vehicle, and possibly a fire or injury.

- Never use a fuse of a higher amperage rating than that indicated, or use any other object in place of a fuse.
- Always use a genuine Lexus fuse or equivalent.
Never replace a fuse with a wire, even as a temporary fix.
- Do not modify the fuses or fuse boxes.

 **NOTICE**

■ **Before replacing fuses**

Have the cause of electrical overload determined and repaired by any authorized Lexus retailer or Lexus authorized repairer, or any reliable repairer as soon as possible.

Light bulbs

You may replace the following bulbs by yourself. The difficulty level of replacement varies depending on the bulb. As there is a danger that components may be damaged, we recommend that replacement is carried out by any authorized Lexus retailer or Lexus authorized repairer, or any reliable repairer.

Preparing for light bulb replacement

Check the wattage of the light bulb to be replaced. (→P. 558)

Removing the engine compartment covers

→P. 405

Bulb locations

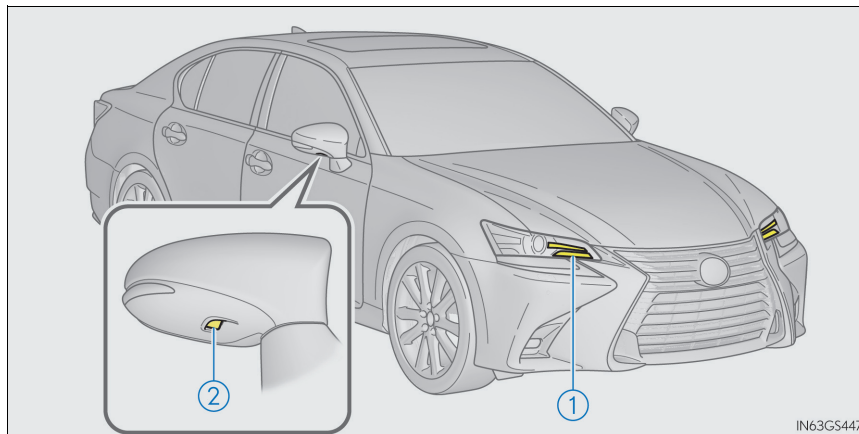

- ① Front turn signal light (vehicles with single-beam headlights)
- ② Outer foot light

Replacing light bulbs

■ Front turn signal light (vehicles with single-beam headlights)

- 1 For the left side only: Remove the bolt and move the washer fluid filler opening.

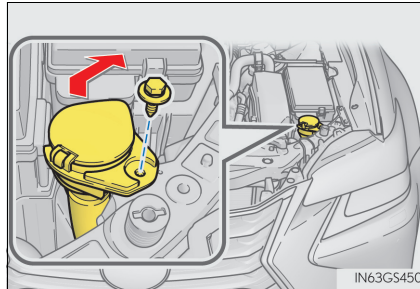

- 2 Turn the bulb base counterclockwise.

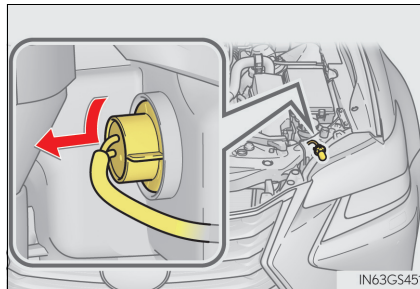

- 3 Remove the light bulb.

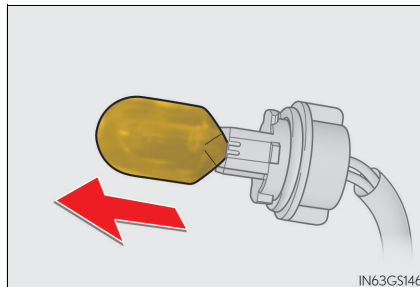

444 6-3. Do-it-yourself maintenance

- 4 When installing, reverse the steps listed.

After installing the bulb base, secure the cord with the clips and if replacing the left side bulb, make sure to install the bolt for the washer fluid filler opening in its original position.

▶ Right side

▶ Left side

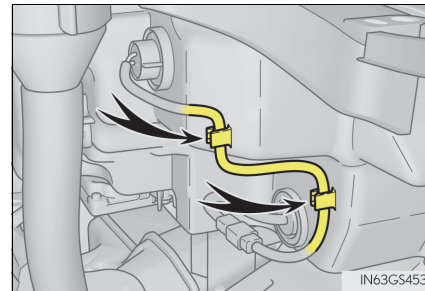
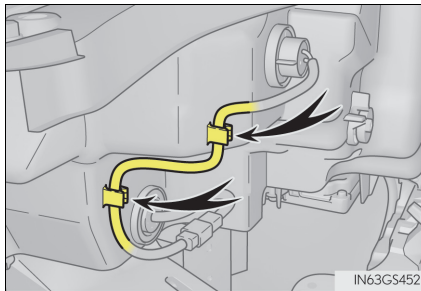

■ Outer foot lights

- 1 Press the upper part of the outside rear view mirror to tilt the mirror face upward, and apply protective tape to the lower part of the mirror cover.

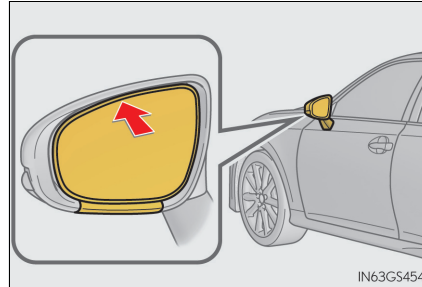

- 2 Insert 2 flathead screwdrivers wrapped in protective tape, and disconnect the tabs behind the mirror.

Pry the mirror out toward you, disconnecting the 2 tabs at a time.

Work carefully, ensuring that you do not drop the mirror.

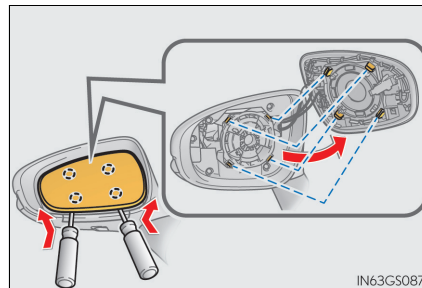

- 3 Disconnect the connectors behind the mirror, and remove the mirror.

When removing the thin connectors, make sure to mark one of the connectors with a piece of tape, to avoid mixing them up when reinstalling.

Work carefully, ensuring that you do not drop the mirror.

When handling the mirror, do not touch the parts applied with grease.

The number of connectors equipped differs by vehicle specification.

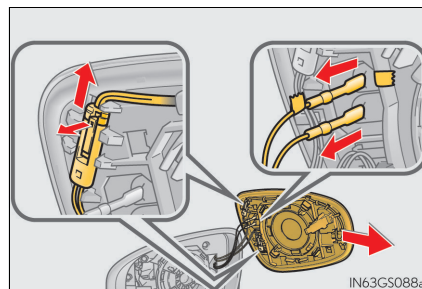

- 4 Remove the screws and take off the mirror cover.

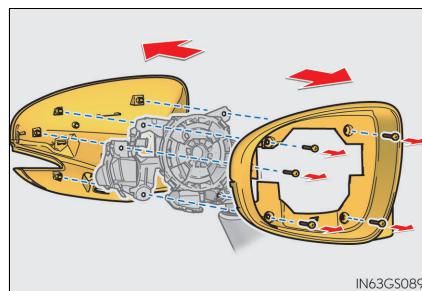

446 6-3. Do-it-yourself maintenance

- 5 Turn the bulb base counterclockwise.

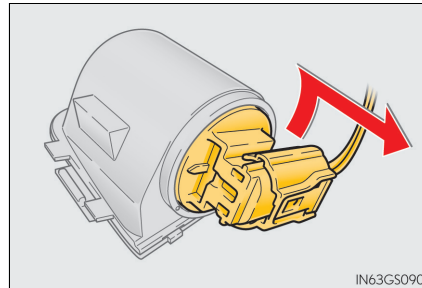

- 6 Remove the light bulb.

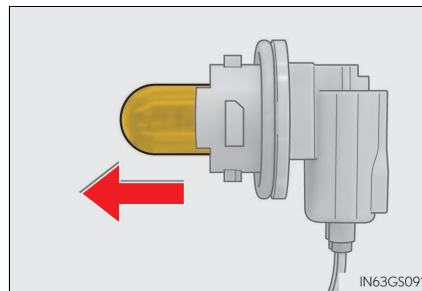

- 7 After installing the new bulb, secure the socket to the light body.

When inserting the socket, align the marks printed on the light body and the socket.

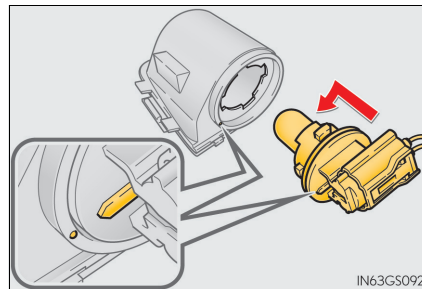

- 8 Install the visor cover on the mirror frame, secure it with a screw, and install the side turn signal light and outer foot light.

Use only the screw position shown in the illustration.

Side turn signal light: Align the tabs on the light and the cover and install.

Outer foot light: Interlock the tabs in the groove of the light body with those on the cover, and secure.

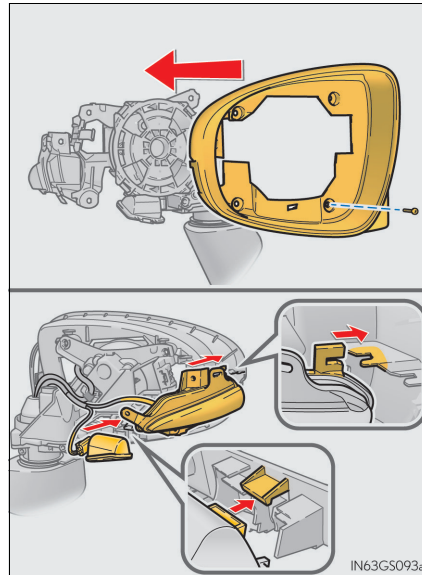

- 9 Disconnect the tabs, and separate the top and bottom of the rear side cover of the mirror.

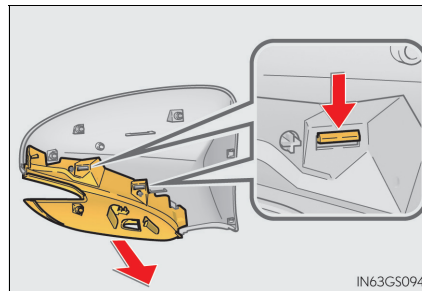

- 10** Install the cover of the back end of the mirror, installing the lower side and the upper side in that order.

When installing the lower side of the cover, insert the side turn signal light pin into the hole in the cover.

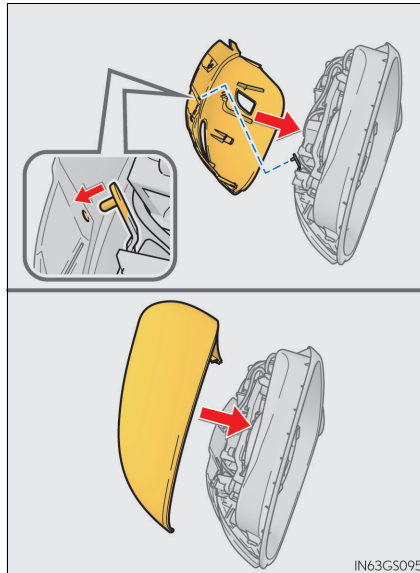

- 11** Secure the cover with screws and reconnect the connectors back together.

Secure the cords by returning them to the hooks as they were.

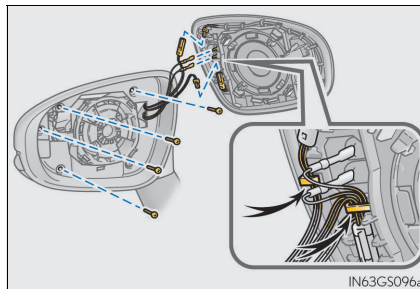

- 12** Align the tabs, and secure the mirror by pushing in each diagonally-opposite pair of tabs in order.

Make sure to insert the tabs in order as shown in the illustration, and push them in until a click is heard.

If you do not hear the click, do not force the tabs in. Instead, remove the mirror and check that the tabs are aligned.

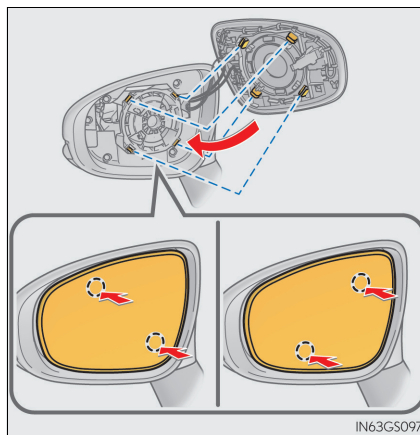

■ Replacing the following bulbs

If any of the lights listed below has burnt out, have it replaced by any authorized Lexus retailer or Lexus authorized repairer, or any reliable repairer.

- Headlights
- Front position lights/daytime running lights
- Front fog lights
- Front turn signal lights (vehicles with triple-beam headlights)
- Side turn signal lights
- Stop/tail lights
- Stop lights
- Rear fog light
- Rear turn signal lights
- Back-up lights
- High mounted stoplight
- License plate lights

■ LED Lights

The lights other than the front turn signal light (vehicles with single-beam headlights) and outer foot lights each consist of a number of LEDs. If any of the LEDs burn out, take your vehicle to any authorized Lexus retailer or Lexus authorized repairer, or any reliable repairer to have the light replaced.

■ Condensation build-up on the inside of the lens

Temporary condensation build-up on the inside of the headlight lens does not indicate a malfunction. Contact any authorized Lexus retailer or Lexus authorized repairer, or any reliable repairer for more information in the following situations:

- Large drops of water have built up on the inside of the lens.
- Water has built up inside the headlight.

■ When replacing light bulbs

→P. 441

 **WARNING**

■ **Replacing light bulbs**

- Turn off the lights. Do not attempt to replace the bulb immediately after turning off the lights.
The bulbs become very hot and may cause burns.
- Do not touch the glass portion of the light bulb with bare hands. When it is unavoidable to hold the glass portion, use and hold with a clean dry cloth to avoid getting moisture and oils on the bulb.
Also, if the bulb is scratched or dropped, it may blow out or crack.
- Fully install light bulbs and any parts used to secure them. Failure to do so may result in heat damage, fire, or water entering the headlight unit. This may damage the headlights or cause condensation to build up on the lens.

■ **To prevent damage or fire**

- Make sure bulbs are fully seated and locked.
- Check the wattage of the bulb before installing to prevent heat damage.

 **NOTICE**

■ **When replacing the outer foot lights**

If the front window is stopping you from conducting the replace operation properly, open the window on the side you are working on to allow you enough space to work. Continuing the operation without giving yourself enough space to work could lead you to scratch the vehicle.

When trouble arises

7

7-1. Essential information

Emergency flashers	452
If your vehicle has to be stopped in an emergency	453

7-2. Steps to take in an
emergency

If your vehicle needs to be towed.....	454
If you think something is wrong.....	459
If a warning light turns on or a warning buzzer sounds.....	460
If a warning message is displayed	466
If you have a flat tire (vehicles with spare tire).....	498
If you have a flat tire (vehicles without spare tire).....	509
If the hybrid system will not start.....	523
If the parking brake cannot be released.....	525
If the electronic key does not operate properly	527
If the 12-volt battery is discharged	530
If your vehicle overheats.....	535
If the vehicle becomes stuck	542

Emergency flashers

The emergency flashers are used to warn other drivers when the vehicle has to be stopped in the road due to a breakdown, etc.

Press the switch.

All the turn signal lights will flash.
To turn them off, press the switch once again.

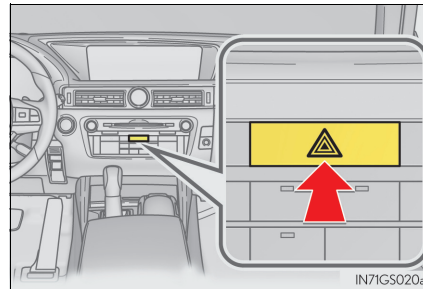

■ Emergency flashers

If the emergency flashers are used for a long time while the hybrid system is not operating (while the "READY" indicator is not illuminated), the 12-volt battery may discharge.

If your vehicle has to be stopped in an emergency

Only in an emergency, such as if it becomes impossible to stop the vehicle in the normal way, stop the vehicle using the following procedure:

- 1 Steadily step on the brake pedal with both feet and firmly depress it.
Do not pump the brake pedal repeatedly as this will increase the effort required to slow the vehicle.
- 2 Shift the shift lever to N.
 - ▶ If the shift lever is shifted to N
- 3 After slowing down, stop the vehicle in a safe place by the road.
- 4 Stop the hybrid system.
 - ▶ If the shift lever cannot be shifted to N
- 3 Keep depressing the brake pedal with both feet to reduce vehicle speed as much as possible.

- 4 To stop the hybrid system, press and hold the power switch for 2 consecutive seconds or more, or press it briefly 3 times or more in succession.

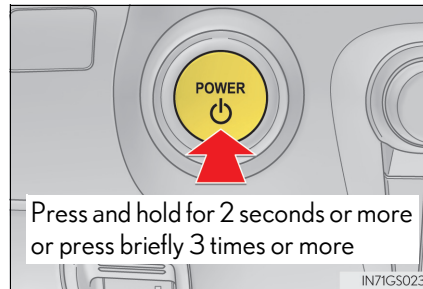

- 5 Stop the vehicle in a safe place by the road.

WARNING

■ If the hybrid system has to be turned off while driving

Power assist for the steering wheel will be lost, making the steering wheel heavier to turn. Decelerate as much as possible before turning off the hybrid system.

If your vehicle needs to be towed

If towing is necessary, we recommend having your vehicle towed by any authorized Lexus retailer or Lexus authorized repairer, or any reliable repairer or commercial towing service, using a wheel-lift type truck or flatbed truck.

Use a safety chain system for all towing, and abide by all state/provincial and local laws.

Situations when it is necessary to contact dealers before towing

The following may indicate a problem with your transmission. Contact any authorized Lexus retailer or Lexus authorized repairer, or any reliable repairer or commercial towing service before towing.

- The hybrid warning message shows on the multi-information display and the vehicle does not move.
- The vehicle makes an abnormal sound.

Towing with a sling-type truck

Do not tow with a sling-type truck to prevent body damage.

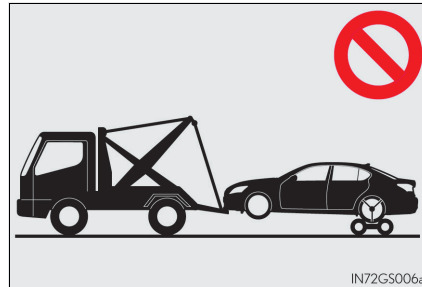

Towing with a wheel-lift type truck

► From the front

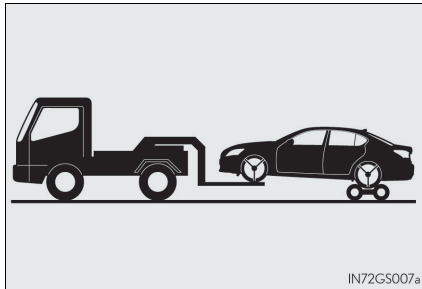

Use a towing dolly under the rear wheels.

► From the rear

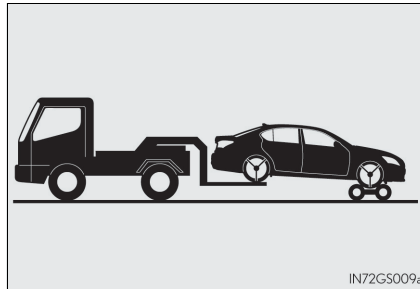

Use a towing dolly under the front wheels.

Using a flatbed truck

If your vehicle is transported by a flatbed truck, it should be tied down at the locations shown in the illustration.

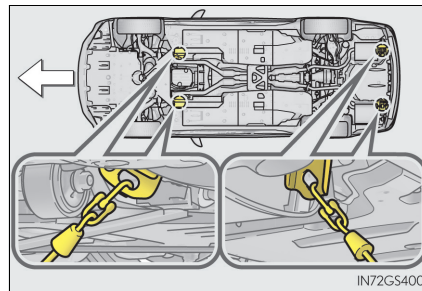

If you use chains or cables to tie down your vehicle, the angles shaded in black must be 45°.

Do not overly tighten the tie downs or the vehicle may be damaged.

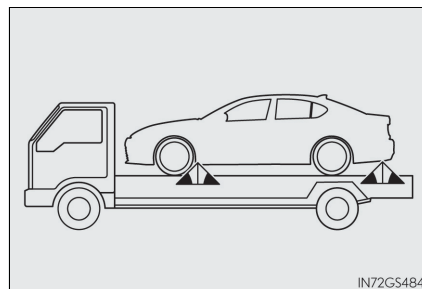

Emergency towing

If a tow truck is not available in an emergency, your vehicle may be temporarily towed using cables or chains secured to the emergency towing eyelets. This should only be attempted on hard surfaced roads for short distances at under 30 km/h (18 mph).

A driver must be in the vehicle to steer and operate the brakes. The vehicle's wheels, drive train, axles, steering and brakes must be in good condition.

Emergency towing procedure

- 1 Take out the towing eyelet. (→P. 499, 511)
- 2 Remove the eyelet cover using a flathead screwdriver.

To protect the bodywork, place a rag between the screwdriver and the vehicle body as shown in the illustration.

▶ Except F SPORT models

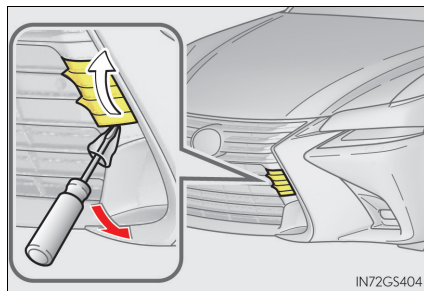

▶ F SPORT models

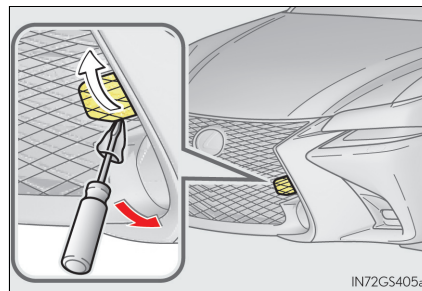

- 3 Insert the towing eyelet into the hole and tighten partially by hand.

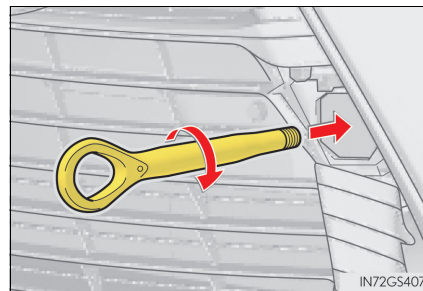

- 4 Tighten down the towing eyelet securely using a wheel nut wrench or hard metal bar.

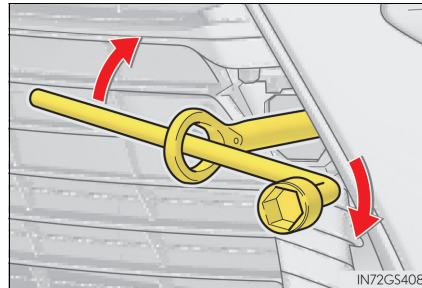

- 5 Securely attach cables or chains to the towing eyelet.
Take care not to damage the vehicle body.
- 6 Enter the vehicle being towed and start the hybrid system.
If the hybrid system does not start, turn the power switch to ON mode.
- 7 Shift the shift lever to N and release the parking brake.
When the shift lever cannot be shifted: →P. 229

■ While towing

If the hybrid system is off, the power assist for the brakes and steering will not function, making steering and braking more difficult.

■ Wheel nut wrench

Wheel nut wrench is installed in trunk. (→P. 499, 511)

⚠ WARNING

Observe the following precautions.
Failure to do so may result in death or serious injury.

■ When towing the vehicle

Be sure to transport the vehicle with all four wheels raised off the ground. If the vehicle is towed with the tires contacting the ground, the drivetrain and related parts may be damaged, an accident may occur due to a change in direction of the vehicle or electricity generated by the operation of the motor may cause a fire to occur depending on the nature of the damage or malfunction.

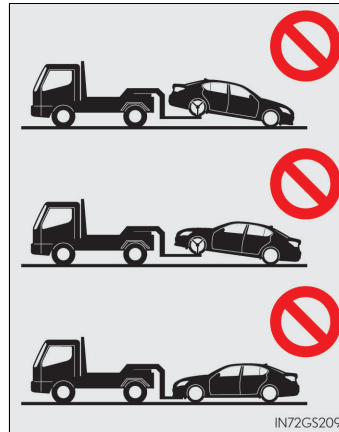
**■ While towing**

- When towing using cables or chains, avoid sudden starts, etc. which place excessive stress on the towing eyelets, cables or chains. The towing eyelets, cables or chains may become damaged, broken debris may hit people, and cause serious damage.
- Do not turn the power switch off.
There is a possibility that the steering wheel is locked and cannot be operated.

■ Installing towing eyelets to the vehicle

Make sure that towing eyelets are installed securely.
If not securely installed, towing eyelets may come loose during towing.

⚠ NOTICE**■ To prevent damage to the vehicle when towing using a wheel-lift type truck**

- Do not tow the vehicle from the rear when the power switch is off. The steering lock mechanism is not strong enough to hold the front wheels straight.
- When raising the vehicle, ensure adequate ground clearance for towing at the opposite end of the raised vehicle. Without adequate clearance, the vehicle could be damaged while being towed.

■ To prevent damage to the vehicle when towing with a sling-type truck

Do not tow with a sling-type truck, either from the front or rear.

■ To prevent damage to the vehicle during emergency towing

Do not secure cables or chains to the suspension components.

If you think something is wrong

If you notice any of the following symptoms, your vehicle probably needs adjustment or repair. Contact any authorized Lexus retailer or Lexus authorized repairer, or any reliable repairer as soon as possible.

Visible symptoms

- Fluid leaks under the vehicle.
(Water dripping from the air conditioning after use is normal.)
- Flat-looking tires or uneven tire wear
- Engine coolant temperature gauge needle continually points higher than normal.

Audible symptoms

- Changes in exhaust sound
- Excessive tire squeal when cornering
- Strange noises related to the suspension system
- Pinging or other noises related to the hybrid system





Operational symptoms





- Engine missing, stumbling or running roughly
- Appreciable loss of power
- Vehicle pulls heavily to one side when braking
- Vehicle pulls heavily to one side when driving on a level road
- Loss of brake effectiveness, spongy feeling, pedal almost touches the floor







If a warning light turns on or a warning buzzer sounds



Calmly perform the following actions if any of the warning lights comes on or flashes. If a light comes on or flashes, but then goes off, this does not necessarily indicate a malfunction in the system. However, if this continues to occur, have the vehicle inspected by any authorized Lexus retailer or Lexus authorized repairer, or any reliable repairer.

Warning light and warning buzzer list

Warning light	Warning light/Details/Actions
	<p>Brake system warning light (warning buzzer)</p> <ul style="list-style-type: none"> • Low brake fluid • Malfunction in the electronically controlled brake system <p>→ Immediately stop the vehicle in a safe place and contact any authorized Lexus retailer or Lexus authorized repairer, or any reliable repairer. Continuing to drive the vehicle may be dangerous.</p>
 (If equipped)	<p>Charging system warning light</p> <p>Indicates a malfunction in the vehicle's charging system</p> <p>→ Immediately stop the vehicle in a safe place and contact any authorized Lexus retailer or Lexus authorized repairer, or any reliable repairer.</p>
	<p>Malfunction indicator lamp</p> <p>Indicates a malfunction in:</p> <ul style="list-style-type: none"> • The hybrid system; • The emission control system (if equipped); • The electronic engine control system; • The electronic throttle control system; or • The electronic hybrid transmission control system (if equipped) <p>→ Have the vehicle inspected by any authorized Lexus retailer or Lexus authorized repairer, or any reliable repairer immediately.</p>
	<p>SRS warning light</p> <p>Indicates a malfunction in:</p> <ul style="list-style-type: none"> • The SRS airbag system; or • The seat belt pretensioner system <p>→ Have the vehicle inspected by any authorized Lexus retailer or Lexus authorized repairer, or any reliable repairer immediately.</p>

Warning light	Warning light/Details/Actions
	<p>ABS warning light Indicates a malfunction in:</p> <ul style="list-style-type: none"> • The ABS; or • The brake assist system <p>→ Have the vehicle inspected by any authorized Lexus retailer or Lexus authorized repairer, or any reliable repairer immediately.</p>
	<p>Electric power steering system warning light (warning buzzer) Indicates a malfunction in the EPS (Electric Power Steering) system</p> <p>→ Have the vehicle inspected by any authorized Lexus retailer or Lexus authorized repairer, or any reliable repairer immediately.</p>
 <p>(Flashes) (If equipped)</p>	<p>PCS (Pre-Crash Safety system) warning light</p> <ul style="list-style-type: none"> ● When the warning light flashes (and a buzzer sounds): Indicates a malfunction in the PCS (Pre-Crash Safety system) → Have the vehicle inspected by any authorized Lexus retailer or Lexus authorized repairer, or any reliable repairer immediately. ● When the warning light flashes (and a buzzer does not sound): Indicates that the PCS (Pre-Crash Safety system) is temporarily unavailable, possibly due to either of the following: <ul style="list-style-type: none"> • An area around the radar sensor or camera sensor being dirty or covered with condensation, ice, stickers, etc. → Clear the dirt, condensation, ice, stickers, etc. (→P. 264, 285) • Radar sensor or camera sensor operational conditions (such as temperature etc.) being not met → Driving is possible in this case. The PCS (Pre-Crash Safety system) will be enabled if the operational conditions (such as temperature etc.) are met again. ● When the warning light is illuminated: Either the VSC (Vehicle Stability Control) system or PCS (Pre-Crash Safety system) is disabled or both are disabled. → To enable the PCS (Pre-Crash Safety system), enable both the VSC system and PCS (Pre-Crash Safety system). (→P. 281, 327)
	<p>Slip indicator Indicates a malfunction in:</p> <ul style="list-style-type: none"> • The VSC system; • The TRC system; or • The hill-start assist control system <p>→ Have the vehicle inspected by any authorized Lexus retailer or Lexus authorized repairer, or any reliable repairer immediately. The light will flash when the VSC, TRC or ABS system is operating.</p>

Warning light	Warning light/Details/Actions
 (Flashes) (If equipped)	“AFS OFF” indicator Indicates a malfunction in the adaptive front-lighting system → Have the vehicle inspected by any authorized Lexus retailer or Lexus authorized repairer, or any reliable repairer immediately.
 (Flashes)	Brake hold operated indicator Indicates a malfunction in the brake hold system → Have the vehicle inspected by any authorized Lexus retailer or Lexus authorized repairer, or any reliable repairer immediately.
 (Flashes)	Parking brake indicator Indicates a malfunction in the parking brake system → Have the vehicle inspected by any authorized Lexus retailer or Lexus authorized repairer, or any reliable repairer immediately.
	Brake system warning light Indicates a malfunction in: <ul style="list-style-type: none"> • The electronically controlled brake system; • The regenerative braking system; or • The parking brake system → Have the vehicle inspected by any authorized Lexus retailer or Lexus authorized repairer, or any reliable repairer immediately.
	Low fuel level warning light Indicates remaining fuel is approximately 9.9 L (2.6 gal., 2.2 Imp.gal.) or less → Refuel the vehicle.
	Seat belt reminder light (warning buzzer)* Warns the driver and/or front passenger to fasten their seat belts → Fasten the seat belt. If the front passenger’s seat is occupied, the front passenger’s seat belt also needs to be fastened to make the warning light (warning buzzer) off.
	Master warning light A buzzer sounds and the warning light comes on and flashes to indicate that the master warning system has detected a malfunction. → P. 466

Warning light	Warning light/Details/Actions
 <p>(If equipped)</p>	<p>Tire pressure warning light When the light comes on: Low tire inflation pressure such as</p> <ul style="list-style-type: none"> • Natural causes (→P. 464) • Flat tire (→P. 498, 509) <p>→ Adjust the tire inflation pressure to the specified level. The light will turn off after a few minutes. In case the light does not turn off even if the tire inflation pressure is adjusted, have the system checked by any authorized Lexus retailer or Lexus authorized repairer, or any reliable repairer.</p> <p>When the light comes on after blinking for 1 minute: Malfunction in the tire pressure warning system</p> <p>→ Have the system checked by any authorized Lexus retailer or Lexus authorized repairer, or any reliable repairer.</p>
 <p>(If equipped)</p>	<p>LKA warning light The warning light comes on and a warning message is displayed to indicate that the LKA (Lane-Keeping Assist) system is not available temporarily or has detected a malfunction.</p> <p>→ P. 478</p>

*: Driver's and front passenger's seat belt buzzer:

The driver's and front passenger's seat belt buzzer sounds to alert the driver and front passenger that his or her seat belt is not fastened. The buzzer sounds intermittently for 30 seconds after the vehicle reaches a speed of 20 km/h (12 mph). Then, if the seat belt is still unfastened, the buzzer will sound in a different tone for 90 more seconds.

■ Front passenger detection sensor, seat belt reminder and warning buzzer

- If luggage is placed on the front passenger seat, the front passenger detection sensor may cause the warning light to flash and the warning buzzer to sound even if a passenger is not sitting in the seat.
- If a cushion is placed on the seat, the sensor may not detect a passenger, and the warning light may not operate properly.

■ If the malfunction indicator lamp comes on while driving

The malfunction indicator lamp will come on if the fuel tank becomes completely empty. If the fuel tank is empty, refuel the vehicle immediately. The malfunction indicator lamp will go off after several trips.

If the malfunction indicator lamp does not go off, contact any authorized Lexus retailer or Lexus authorized repairer, or any reliable repairer as soon as possible.

■ Electric power steering system warning light (warning buzzer)

When the 12-volt battery charge becomes insufficient or the voltage temporarily drops, the electric power steering system warning light may come on and the warning buzzer may sound.

■ **When the tire pressure warning light comes on (if equipped)**

Carry out the following procedure after the tire temperature has lowered sufficiently.

- Check the tire inflation pressure and adjust to the appropriate level.
- If the warning light does not go out even after several minutes, check that the tire inflation pressure is at the specified level and carry out initialization.

The warning light may come on again if the above operations are conducted without first allowing the tire temperature to lower sufficiently.

■ **The tire pressure warning light may come on due to natural causes**

The tire pressure warning light may come on due to natural causes such as natural air leaks and tire inflation pressure changes caused by temperature. In this case, adjusting the tire inflation pressure will turn off the warning light (after a few minutes).

■ **When a tire is replaced with a spare tire**

The compact spare tire is not equipped with a tire pressure warning valve and transmitter. If a tire goes flat, the tire pressure warning light will not turn off even though the flat tire has been replaced with the spare tire.

■ **Conditions that the tire pressure warning system may not function properly**

→P. 420

■ **If the tire pressure warning light frequently comes on after blinking for 1 minute**

If the tire pressure warning light frequently comes on after blinking for 1 minute when the power switch is turned to ON mode, have it checked by any authorized Lexus retailer or Lexus authorized repairer, or any reliable repairer.

■ **Warning buzzer**

In some cases, the buzzer may not be heard because of noisy place or an audio sound.

 **WARNING****■ If both the ABS and the brake system warning lights remain on**

Stop your vehicle in a safe place immediately and contact any authorized Lexus retailer or Lexus authorized repairer, or any reliable repairer. The vehicle will become extremely unstable during braking, and the ABS system may fail, which could cause an accident resulting in death or serious injury.

■ When the electric power steering system warning light comes on

The steering wheel may become extremely heavy.
If the steering wheel becomes heavier than usual when operating, hold firmly and operate using more force than usual.

■ If the tire pressure warning light comes on

Be sure to observe the following precautions. Failure to do so could cause a loss of vehicle control and result in death or serious injury.

- Stop your vehicle in a safe place as soon as possible. Adjust the tire inflation pressure immediately.
- If the tire pressure warning light comes on even after tire inflation pressure adjustment, it is probable that you have a flat tire. Check the tires. If a tire is flat, change it with the spare tire and have the flat tire repaired by the nearest any authorized Lexus retailer or Lexus authorized repairer, or any reliable repairer.
- Avoid abrupt maneuvering and braking. If the vehicle tires deteriorate, you could lose control of the steering wheel or the brakes.

■ If a blowout or sudden air leakage should occur

The tire pressure warning system may not activate immediately.

 **NOTICE****■ To ensure the tire pressure warning system operates properly**

Do not install tires with different specifications or makers, as the tire pressure warning system may not operate properly.

If a warning message is displayed

If a warning is shown on the multi-information display, stay calm and perform the following actions:

▶ Except F SPORT models

▶ F SPORT models

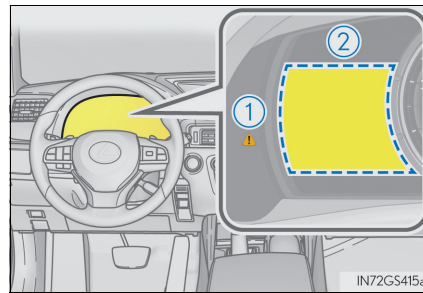
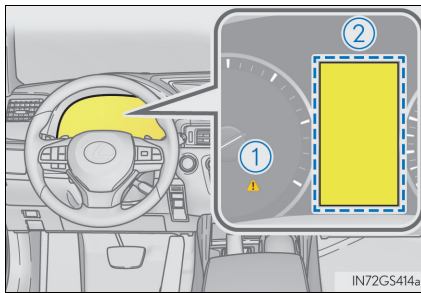

① Master warning light





The master warning light also comes on or flashes in order to indicate that a message is currently being displayed on the multi-information display.





② Multi-information display

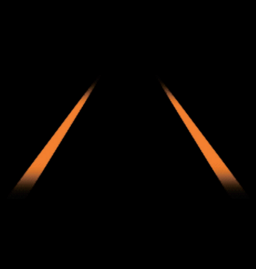



If any of the warning light comes on again after the following actions have been performed, contact any authorized Lexus retailer or Lexus authorized repairer, or any reliable repairer.



Warning message and warning buzzer list





Warning message	Details/Actions
 <p>(If equipped)</p>	<p>Indicates that there is a high possibility of a frontal collision, or that the pre-crash braking function is operating</p> <p>At the same time, BRAKE ! will appear on the head-up display.</p> <p>A buzzer also sounds.</p> <p>→ Avoid the collision by decelerating using the brakes or taking other evasive actions.</p>





Warning message	Details/Actions
 <p>(If equipped)</p>	<p>Indicates that your vehicle is nearing the vehicle ahead (in vehicle-to-vehicle distance control mode)</p> <p>At the same time,  will appear on the head-up display (the image flashes). A buzzer also sounds.</p> <p>→ Slow the vehicle by applying the brakes.</p>
 <p>(If equipped)</p>	<p>Indicates that the vehicle has deviated from the lane (while the LKA [Lane-Keeping Assist] system is operating)</p> <p>The lane line on the side the vehicle has deviated from flashes in amber.</p> <p>At the same time,  will appear on the head-up display (the image flashes). A buzzer also sounds.</p> <p>→ Check around the vehicle and back to inside of the lane lines.</p>
<p>Braking Power Low</p> <p>Stop in a Safe Place</p> <p>See Owner's Manual</p>  <p>(Flashes)</p>	<p>Indicates a malfunction in the brake system A buzzer also sounds.</p> <p>→ Have the vehicle inspected by any authorized Lexus retailer or Lexus authorized repairer, or any reliable repairer. Continuing to drive the vehicle may be dangerous.</p>





Warning message	Details/Actions
<p data-bbox="395 499 651 689"> Stop the vehicle in a safe place Shift to P position </p>  <p data-bbox="408 759 467 779">(Flashes)</p>	<p data-bbox="675 566 1235 701"> Indicates a malfunction in the gasoline engine or that the shift lever is in N for a long period of time A buzzer also sounds. → Release the accelerator pedal and change the shift position to D, S or R. </p>
<p data-bbox="395 813 651 981"> Shift to P Before Exiting Vehicle </p>  <p data-bbox="408 1050 467 1070">(Flashes)</p>	<p data-bbox="675 880 1235 992"> Indicates that the driver's door was opened with the shift position in any position other than P A buzzer also sounds. → Shift the shift position to P. </p>
<p data-bbox="395 1104 651 1294"> Hybrid System Malfunction Do Not Be Towed </p> 	<p data-bbox="675 1171 1235 1305"> Indicates a malfunction in the hybrid system A buzzer also sounds. → Immediately stop the vehicle in a safe place and contact any authorized Lexus retailer or Lexus authorized repairer, or any reliable repairer. </p>
	<p data-bbox="675 1395 1235 1664"> Indicates that hood or one or more of the doors or trunk are not fully closed The system also indicates which hood or doors or trunk are not fully closed. If the vehicle reaches a speed of 5 km/h (3 mph),  flashes and a buzzer sounds to indicate that the hood or door(s) or trunk are not yet fully closed. → Make sure that hood or all doors or trunk are closed. </p>







Warning message	Details/Actions
  (If equipped)	<p>Indicates a malfunction in the Lexus parking assist All assist-sensors flash. A buzzer also sounds. → Have the vehicle inspected by any authorized Lexus retailer or Lexus authorized repairer, or any reliable repairer.</p>
  (If equipped)	<p>Indicates that Lexus parking assist-sensor is dirty or covered with ice A buzzer also sounds. → Clean the sensor.</p>
<p>EPB can't be Released</p> <p>Close Door and Fasten Your Seatbelt</p>  (Flashes)	<p>Indicates an attempt was made to release the parking brake with a door open or the front passenger's seat belt unfastened A buzzer also sounds. → Close all doors and fasten the front passenger's seat belt before releasing the parking brake.</p>





Warning message	Details/Actions
<p data-bbox="395 495 651 678">Shift to P Before Exiting Vehicle</p>  <p data-bbox="408 748 467 768">(Flashes)</p>	<p data-bbox="675 573 1233 685">Indicates that the driver's door was opened with the shift position in any position other than P A buzzer also sounds. → Shift the shift position to P.</p>
<p data-bbox="395 801 651 1014">Shift Is in N Release Accelerator Before Shifting</p>  <p data-bbox="408 1095 467 1115">(Flashes)</p>	<p data-bbox="675 887 1233 1021">Indicates that the accelerator pedal is depressed while the shift lever is in N A buzzer also sounds. → Release the accelerator pedal and shift the shift position to D, S or R.</p>
<p data-bbox="395 1149 651 1395">Depress Brake When Vehicle Is Stopped Hybrid System May Overheat</p>  <p data-bbox="408 1476 467 1496">(Flashes)</p>	<p data-bbox="675 1245 1233 1379">Indicates that the accelerator pedal is depressed while the shift lever is in N A buzzer also sounds. → Release the accelerator pedal and shift the shift position to D, S or R.</p>



Warning message	Details/Actions
<p data-bbox="395 495 651 584">Hybrid Battery Low</p> <p data-bbox="395 629 651 674">Hybrid System Stopped</p> <p data-bbox="395 707 651 797">Shift to P and Restart</p>  <p data-bbox="408 864 467 887">(Flashes)</p>	<p data-bbox="675 618 1233 707">Indicates that the hybrid battery (traction battery) power has dropped because a long period of time has elapsed after shifting the shift lever to N</p> <p data-bbox="675 707 1233 752">A buzzer also sounds.</p> <p data-bbox="675 752 1233 797">→ Restart the hybrid system when starting the vehicle.</p>
<p data-bbox="395 931 651 1021">Hybrid System Malfunction</p> <p data-bbox="395 1055 651 1144">Stop in a Safe Place See Owner's Manual</p> 	<p data-bbox="675 965 1233 1010">Indicates a malfunction in the hybrid system</p> <p data-bbox="675 1010 1233 1055">Depending on the malfunction, troubleshooting methods may also be displayed.</p> <p data-bbox="675 1055 1233 1099">A buzzer also sounds.</p> <p data-bbox="675 1099 1233 1189">→ Immediately stop the vehicle in a safe place and contact any authorized Lexus retailer or Lexus authorized repairer, or any reliable repairer.</p>
<p data-bbox="395 1256 651 1346">Hybrid Battery Low</p> <p data-bbox="395 1379 651 1469">Shift Out of N to Recharge</p>  <p data-bbox="408 1536 467 1559">(Flashes)</p>	<p data-bbox="675 1335 1233 1379">Indicates that the traction battery is low</p> <p data-bbox="675 1379 1233 1424">A buzzer also sounds.</p> <p data-bbox="675 1424 1233 1514">→ When stopping the vehicle for a long period of time, shift the shift lever to P. The battery cannot be charged with the shift lever in N.</p>
<p data-bbox="395 1603 651 1693">Check Power Steering System</p>  	<p data-bbox="675 1603 1233 1648">Indicates a malfunction in the EPS (Electric Power Steering) system</p> <p data-bbox="675 1648 1233 1693">A buzzer also sounds.</p> <p data-bbox="675 1693 1233 1783">→ Have the vehicle inspected by any authorized Lexus retailer or Lexus authorized repairer, or any reliable repairer.</p>





Warning message	Details/Actions
<p data-bbox="395 495 651 607">Release Parking Brake</p>  <p data-bbox="408 678 467 696">(Flashes)</p>	<p data-bbox="675 539 1235 645">Indicates that the vehicle is being driven at 5 km/h (3 mph) or more with the parking brake still engaged. A buzzer also sounds. → Release the parking brake.</p>
<p data-bbox="395 730 651 864">Vehicle May Roll Shift to P</p>  <p data-bbox="408 936 467 954">(Flashes)</p>	<p data-bbox="675 786 1235 891">Indicates that the parking brake is engaged with the shift position not in P A buzzer also sounds. → Change the shift position to P.</p>
<p data-bbox="395 987 651 1234">Brake Hold Fault Depress Brake to Deactivate Visit Your Dealer</p> 	<p data-bbox="675 1055 1235 1234">Indicates a malfunction in the brake hold system A buzzer also sounds. → Depress the brake pedal to turn off the brake hold system. Have the vehicle inspected by any authorized Lexus retailer or Lexus authorized repairer, or any reliable repairer.</p>
<p data-bbox="395 1346 651 1547">Brake Hold Warning Depress Brake on Slope</p>	<p data-bbox="675 1379 1235 1514">Indicates that the brake hold system is turned on while on a steep slope A buzzer also sounds. → Do not use only the brake hold system on steep slopes. Be sure to also depress the brake pedal.</p>
<p data-bbox="395 1581 651 1693">EPB Activation Stopped Incompletely</p>   <p data-bbox="408 1765 467 1783">(Flashes) (Flashes)</p>	<p data-bbox="675 1603 1235 1760">Indicates a malfunction in the parking brake system A buzzer also sounds. → Press the parking brake switch. If the warning message is still displayed, have the vehicle inspected by any authorized Lexus retailer or Lexus authorized repairer, or any reliable repairer.</p>









Warning message	Details/Actions
<p data-bbox="437 510 609 667">Release Parking Brake while Depressing Brake</p>	<p data-bbox="675 517 1233 651">Indicates an attempt was made to release the parking brake without depressing the brake pedal A buzzer also sounds. → Release the parking brake while depressing the brake pedal.</p>
<p data-bbox="459 786 584 931"> Release Accelerator</p> <p data-bbox="400 1061 475 1137"> (Flashes)</p>	<p data-bbox="675 853 1233 987">Indicates that the shift position was changed and Drive-Start Control was operated while depressing the accelerator pedal A buzzer also sounds. → Momentarily release the accelerator pedal.</p>
<p data-bbox="448 1178 603 1335">Slippery Road. Cannot Shift to Lower Gear.</p> <p data-bbox="400 1361 475 1415"></p>	<p data-bbox="675 1223 1233 1357">Indicates an attempt was made to shift to 1st gear with the shift position in S while on a slippery surface The vehicle will not shift down from 2nd gear. A buzzer also sounds. → Drive the vehicle in 2nd gear or higher.</p>
<p data-bbox="448 1458 592 1749"> LKA Hold Steering Wheel</p> <p data-bbox="483 1794 563 1816">(If equipped)</p>	<p data-bbox="675 1559 1233 1693">Indicates that the LKA (Lane-Keeping Assist) system has determined that the driver does not have their hands on the steering wheel while the steering control function is on → Firmly hold the steering wheel.</p>







Warning message	Details/Actions
<p data-bbox="395 495 651 712"> LKA Steering Assist Unavailable Hold Steering Wheel </p>  <p data-bbox="483 790 563 808">(If equipped)</p>	<p data-bbox="675 555 1235 741"> Indicates that steering control function is temporarily canceled due to the LKA (Lane-Keeping Assist) system determining that the driver does not have their hands on the steering wheel while the steering control function is on A buzzer also sounds. → Firmly hold the steering wheel. </p>
<p data-bbox="395 837 651 1048"> Parking Brake Overheated Parking Brake Unavailable </p>  	<p data-bbox="675 925 1235 1032"> Indicates that the parking brake system is overheating A buzzer also sounds. → Do not use the parking brake until the message disappears. </p>
<p data-bbox="395 1155 651 1294"> Check Engine Visit Your Dealer </p>  	<p data-bbox="675 1193 1235 1328"> Indicates an engine malfunction A buzzer also sounds. → Have the vehicle inspected by any authorized Lexus retailer or Lexus authorized repairer, or any reliable repairer. </p>
<p data-bbox="395 1406 651 1617"> Check Engine Reduced Engine Power Visit Your Dealer </p>  	<p data-bbox="675 1485 1235 1619"> Indicates an engine malfunction A buzzer also sounds. → Have the vehicle inspected by any authorized Lexus retailer or Lexus authorized repairer, or any reliable repairer. </p>







Warning message	Details/Actions
<p data-bbox="395 495 651 584">SRS Airbag System Malfunction</p> <p data-bbox="432 629 614 663">Visit Your Dealer</p>  	<p data-bbox="675 517 930 551">Indicates a malfunction in:</p> <ul data-bbox="699 551 1054 607" style="list-style-type: none"> • The SRS airbag system; or • The seat belt pretensioner system <p data-bbox="699 607 919 629">A buzzer also sounds.</p> <p data-bbox="675 629 1233 707">→ Have the vehicle inspected by any authorized Lexus retailer or Lexus authorized repairer, or any reliable repairer.</p>
<p data-bbox="395 775 651 864">Antilock Brake System Malfunction</p> <p data-bbox="432 909 614 943">Visit Your Dealer</p> 	<p data-bbox="675 797 930 831">Indicates a malfunction in:</p> <ul data-bbox="699 831 954 887" style="list-style-type: none"> • The ABS; or • The brake assist system <p data-bbox="699 887 919 909">A buzzer also sounds.</p> <p data-bbox="675 909 1233 987">→ Immediately stop the vehicle in a safe place and contact any authorized Lexus retailer or Lexus authorized repairer, or any reliable repairer.</p>
<p data-bbox="395 1055 651 1211">Engine Coolant Temp High</p> <p data-bbox="416 1256 630 1290">Stop in a Safe Place</p> <p data-bbox="416 1335 630 1368">See Owner's Manual</p> 	<p data-bbox="675 1211 1233 1267">Indicates that the engine coolant temperature is too high</p> <p data-bbox="699 1267 919 1290">A buzzer also sounds.</p> <p data-bbox="675 1290 778 1312">→ P. 535</p>
<p data-bbox="395 1491 651 1581">Charging System Malfunction</p> <p data-bbox="456 1626 590 1704">See Owner's Manual</p> 	<p data-bbox="675 1581 1225 1603">Indicates a malfunction in the vehicle's charging system.</p> <p data-bbox="675 1603 1233 1682">→ Immediately stop the vehicle in a safe place and contact any authorized Lexus retailer or Lexus authorized repairer, or any reliable repairer.</p>







Warning message	Details/Actions
<div data-bbox="395 495 651 719" style="background-color: black; color: white; padding: 5px; text-align: center;"> Radar Cruise Control Unavailable Clean Sensor </div> <div data-bbox="395 730 475 786" style="text-align: center;">  </div> <p data-bbox="483 797 563 819">(If equipped)</p>	<p data-bbox="675 595 1233 651">Indicates that the radar sensor is dirty or covered with ice</p> <p data-bbox="699 651 914 674">A buzzer also sounds.</p> <p data-bbox="675 674 882 696">→ Clean the sensor.</p>
<div data-bbox="395 846 651 992" style="background-color: black; color: white; padding: 5px; text-align: center;"> Radar Cruise Control Unavailable </div> <div data-bbox="395 1003 475 1059" style="text-align: center;">  </div> <p data-bbox="483 1070 563 1093">(If equipped)</p>	<p data-bbox="675 898 1233 954">Indicates that the dynamic radar cruise control system cannot be used temporarily due to bad weather</p> <p data-bbox="699 954 914 976">A buzzer also sounds.</p> <p data-bbox="675 976 1233 1032">→ Use the radar cruise control system when it becomes available again.</p>
<div data-bbox="395 1122 651 1379" style="background-color: black; color: white; padding: 5px; text-align: center;"> Radar Cruise Control Unavailable Depress Brake to Resume Driving </div> <div data-bbox="483 1379 563 1402">(If equipped)</div>	<p data-bbox="675 1223 1233 1279">Indicates that the radar cruise control system brake control function is temporarily unavailable</p> <p data-bbox="675 1279 898 1301">→ Depress the brake.</p>
<div data-bbox="395 1435 651 1547" style="background-color: black; color: white; padding: 5px; text-align: center;"> Grille Shutter inoperable </div> <div data-bbox="395 1559 475 1615" style="text-align: center;">  </div> <p data-bbox="483 1626 563 1648">(If equipped)</p>	<p data-bbox="675 1458 1233 1514">Indicates that the grille shutter system cannot operate or the grille shutter is dirty or covered with ice</p> <p data-bbox="699 1514 914 1536">A buzzer also sounds.</p> <p data-bbox="675 1536 1233 1615">→ Have the vehicle inspected by any authorized Lexus retailer or Lexus authorized repairer, or any reliable repairer.</p>

Warning message	Details/Actions
<p data-bbox="395 495 651 607">Check Entry & Start System</p>  <p data-bbox="408 680 611 719">(Flashes) (Vehicles with entry function)</p>	<p data-bbox="675 533 1225 589">Indicates a malfunction in the smart entry & start system A buzzer also sounds.</p> <p data-bbox="675 591 1233 669">→ Have the vehicle inspected by any authorized Lexus retailer or Lexus authorized repairer, or any reliable repairer.</p>
<p data-bbox="395 752 651 887">Blind Spot Monitor Unavailable</p>  <p data-bbox="483 981 563 999">(If equipped)</p>	<p data-bbox="675 801 1233 880">Indicates that a Blind Spot Monitor sensor or the surrounding area on the bumper is dirty or covered with ice A buzzer also sounds.</p> <p data-bbox="675 882 1233 938">→ Clean the sensor and its surrounding area on the bumper.</p>
<p data-bbox="395 1025 651 1160">Cruise Control Malfunction</p> <p data-bbox="395 1162 651 1196">Visit Your Dealer</p> 	<p data-bbox="675 1025 1233 1081">Indicates a malfunction in the cruise control system or dynamic radar cruise control system (if equipped)</p> <p data-bbox="675 1084 1233 1184">Press the "ON/OFF" button once to deactivate the system, and then press the button again to reactivate the system. A buzzer also sounds.</p> <p data-bbox="675 1187 1233 1265">→ Have the vehicle inspected by any authorized Lexus retailer or Lexus authorized repairer, or any reliable repairer.</p>
<p data-bbox="395 1308 651 1397">Cruise Control Fault</p> <p data-bbox="395 1442 651 1520">Press Brake to Deactivate</p> <p data-bbox="395 1565 651 1599">Visit Your Dealer</p>  <p data-bbox="483 1693 563 1711">(If equipped)</p>	<p data-bbox="675 1408 1233 1464">Indicates a malfunction in the dynamic radar cruise control with full-speed range</p> <p data-bbox="675 1467 1233 1500">Depress the brake pedal. A buzzer also sounds.</p> <p data-bbox="675 1503 1233 1581">→ Have the vehicle inspected by any authorized Lexus retailer or Lexus authorized repairer, or any reliable repairer.</p>





Warning message	Details/Actions
<div style="background-color: black; color: white; padding: 10px; text-align: center;"> <p>Lane Keeping Assist Malfunction</p> <p>Visit Your Dealer</p> </div> <div style="display: flex; justify-content: center; gap: 10px; margin-top: 5px;">   </div> <p style="text-align: center; font-size: small;">(If equipped)</p>	<p>Indicates a malfunction in the LKA (Lane-Keeping Assist) system A buzzer also sounds. → Have the vehicle inspected by any authorized Lexus retailer or Lexus authorized repairer, or any reliable repairer.</p>
<div style="background-color: black; color: white; padding: 10px; text-align: center;"> <p>Forward Camera System Unavailable</p> </div> <div style="display: flex; justify-content: center; gap: 10px; margin-top: 5px;">   </div> <p style="text-align: center; font-size: small;">(Flashes) (If equipped)</p>	<p>The operation conditions of the camera sensor (temperature, etc.) are not met. → When the operation conditions of the camera sensor (temperature, etc.) are met, the following systems will become available.</p> <ul style="list-style-type: none"> • PCS (Pre-Crash Safety system) • LKA (Lane-Keeping Assist) system • RSA (Road Sign Assist) • Dynamic radar cruise control with full-speed range • Dynamic radar cruise control • AHS (Adaptive High-beam System) • Automatic High Beam
<div style="background-color: black; color: white; padding: 10px; text-align: center;"> <p>Lane Keeping Assist Unavailable</p> </div> <div style="display: flex; justify-content: center; gap: 10px; margin-top: 5px;">   </div> <p style="text-align: center; font-size: small;">(If equipped)</p>	<p>Indicates that the system is temporarily unavailable due to a malfunction in a sensor other than the camera sensor A buzzer also sounds. → Turn the LKA (Lane-Keeping Assist) system off, wait for a little while, and then turn the LKA (Lane-Keeping Assist) system back on.</p>
<div style="background-color: black; color: white; padding: 10px; text-align: center;"> <p>Forward Camera System Unavailable</p> <p>Clean Windshield</p> </div> <div style="display: flex; justify-content: center; gap: 10px; margin-top: 5px;">   </div> <p style="text-align: center; font-size: small;">(Flashes) (If equipped)</p>	<p>Dirt, rain, condensation, ice, snow, etc., are present on the windshield in front of the camera sensor. The following systems will be temporarily unusable.</p> <ul style="list-style-type: none"> • PCS (Pre-Crash Safety system) • LKA (Lane-Keeping Assist) system • RSA (Road Sign Assist) • Dynamic radar cruise control with full-speed range • Dynamic radar cruise control • AHS (Adaptive High-beam System) • Automatic High Beam <p>→ Turn the system off, remove any dirt, rain, condensation, ice, snow, etc., from the windshield, and then turn the system back on.</p>



Warning message	Details/Actions
<p data-bbox="395 495 651 674">Pre-Crash Safety Malfunction</p> <p data-bbox="432 629 614 663">Visit Your Dealer</p> <div data-bbox="395 685 564 745">   </div> <p data-bbox="408 745 464 763">(Flashes)</p> <p data-bbox="483 772 560 790">(If equipped)</p>	<p data-bbox="675 555 1233 611">Indicates a malfunction in the PCS (Pre-Crash Safety system)</p> <p data-bbox="695 611 916 638">A buzzer also sounds.</p> <p data-bbox="675 638 1233 719">→ Have the vehicle inspected by any authorized Lexus retailer or Lexus authorized repairer, or any reliable repairer.</p>
<p data-bbox="395 824 651 947">Blind Spot Monitor System Malfunction</p> <p data-bbox="432 999 614 1032">Visit Your Dealer</p> <div data-bbox="395 1055 475 1115">  </div> <p data-bbox="483 1122 560 1140">(If equipped)</p>	<p data-bbox="675 891 1233 947">Indicates a malfunction in the BSM (Blind Spot Monitor) system</p> <p data-bbox="695 947 916 974">A buzzer also sounds.</p> <p data-bbox="675 974 1233 1055">→ Have the vehicle inspected by any authorized Lexus retailer or Lexus authorized repairer, or any reliable repairer.</p>
<p data-bbox="395 1173 651 1279"> Oil Pressure Low</p> <p data-bbox="448 1330 600 1408">Stop in a Safe Place</p> <p data-bbox="416 1458 632 1491">See Owner's Manual</p> <div data-bbox="395 1514 475 1574">  </div>	<p data-bbox="675 1301 1058 1328">Indicates abnormal engine oil pressure</p> <p data-bbox="695 1328 916 1355">A buzzer also sounds.</p> <p data-bbox="675 1355 1233 1435">→ Immediately stop the vehicle in a safe place and contact any authorized Lexus retailer or Lexus authorized repairer, or any reliable repairer.</p>
<p data-bbox="395 1603 651 1709">Check VGRS System</p> <div data-bbox="395 1731 475 1792">  </div> <p data-bbox="483 1794 560 1812">(If equipped)</p>	<p data-bbox="675 1619 1233 1675">Indicates a malfunction in the VGRS (Variable Gear Ratio Steering)</p> <p data-bbox="695 1675 916 1702">A buzzer also sounds.</p> <p data-bbox="675 1702 1233 1783">→ Have the vehicle inspected by any authorized Lexus retailer or Lexus authorized repairer, or any reliable repairer.</p>





Warning message	Details/Actions
<p data-bbox="395 495 651 607">Check DRS System</p>  <p data-bbox="483 685 563 707">(If equipped)</p>	<p data-bbox="675 510 1235 568">Indicates a malfunction in the DRS (Dynamic Rear Steering)</p> <p data-bbox="699 568 916 591">A buzzer also sounds.</p> <p data-bbox="675 595 1235 674">→ Have the vehicle inspected by any authorized Lexus retailer or Lexus authorized repairer, or any reliable repairer.</p>
<p data-bbox="395 730 651 913">Braking Power Low</p> <p data-bbox="435 869 611 898">Visit Your Dealer</p> 	<p data-bbox="675 763 1235 815">Indicates a malfunction in the electronically controlled brake system</p> <p data-bbox="699 815 916 837">A buzzer also sounds.</p> <p data-bbox="675 842 1235 949">→ Immediately stop the vehicle in a safe place and contact any authorized Lexus retailer or Lexus authorized repairer, or any reliable repairer. Continuing to drive in this condition is dangerous.</p>
<p data-bbox="395 1021 651 1133">Parking Brake Unavailable</p>  	<p data-bbox="675 1014 1235 1066">Indicates an attempt was made to engage the parking brake while driving</p> <p data-bbox="699 1066 916 1088">A buzzer also sounds.</p> <p data-bbox="675 1093 1235 1200">→ Press the parking brake switch. If the warning message is still displayed, have the vehicle inspected by any authorized Lexus retailer or Lexus authorized repairer, or any reliable repairer.</p>
<p data-bbox="395 1245 651 1451">Electronic Parking Brake Malfunction</p> <p data-bbox="435 1413 611 1442">Visit Your Dealer</p>  	<p data-bbox="675 1294 1182 1323">Indicates a malfunction in the parking brake system</p> <p data-bbox="699 1323 916 1346">A buzzer also sounds.</p> <p data-bbox="675 1350 1235 1458">→ Press the parking brake switch. If the warning message is still displayed, have the vehicle inspected by any authorized Lexus retailer or Lexus authorized repairer, or any reliable repairer.</p>
<p data-bbox="395 1574 651 1742">Lane Keeping Assist Unavailable at Current Speed</p> <p data-bbox="483 1753 563 1776">(If equipped)</p>	<p data-bbox="675 1619 1235 1671">Indicates that LKA (Lane-Keeping Assist) system cannot be used due to the vehicle speed being too high</p> <p data-bbox="675 1671 823 1693">→ Slow down.</p>



Warning message	Details/Actions
<p data-bbox="395 495 651 607">Turn Lights Off</p>  <p data-bbox="408 678 467 696">(Flashes)</p>	<p data-bbox="675 528 1233 607">Indicates that the power switch is turned off or turned to ACCESSORY mode and the driver's door is opened while the lights are turned on</p> <p data-bbox="699 611 914 629">A buzzer also sounds.</p> <p data-bbox="675 633 890 651">→ Turn the lights off.</p>
<p data-bbox="395 730 651 842">Moon Roof Open</p>  <p data-bbox="408 913 467 931">(Flashes)</p> <p data-bbox="483 943 563 960">(If equipped)</p>	<p data-bbox="675 786 1233 842">Indicates that the moon roof is not fully closed (with the power switch off, and the driver's door open)</p> <p data-bbox="699 846 914 864">A buzzer also sounds.</p> <p data-bbox="675 869 922 887">→ Close the moon roof.</p>
<p data-bbox="395 987 651 1099">Window Open</p>  <p data-bbox="408 1171 467 1189">(Flashes)</p>	<p data-bbox="675 1032 1233 1088">Indicates that the windows are not fully closed (with the power switch off, and the driver's door open)</p> <p data-bbox="699 1093 914 1111">A buzzer also sounds.</p> <p data-bbox="675 1115 930 1133">→ Close all the windows.</p>
<p data-bbox="395 1223 651 1335">Window / Moon Roof Open</p>  <p data-bbox="408 1406 467 1424">(Flashes)</p> <p data-bbox="483 1435 563 1453">(If equipped)</p>	<p data-bbox="675 1267 1233 1346">Indicates that the windows and the moon roof are not fully closed (with the power switch off, and the driver's door open)</p> <p data-bbox="699 1350 914 1368">A buzzer also sounds.</p> <p data-bbox="675 1373 1121 1391">→ Close all the windows and the moon roof.</p>
<p data-bbox="395 1480 651 1592">Brake Hold Malfunction</p> <p data-bbox="395 1615 651 1671">Visit Your Dealer</p>   <p data-bbox="408 1742 467 1760">(Flashes)</p>	<p data-bbox="675 1547 1145 1581">Indicates a malfunction in the brake hold system</p> <p data-bbox="699 1585 914 1603">A buzzer also sounds.</p> <p data-bbox="675 1608 1233 1686">→ Have the vehicle inspected by any authorized Lexus retailer or Lexus authorized repairer, or any reliable repairer.</p>

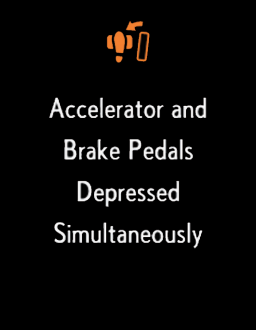

Warning message	Details/Actions
<p>Brake Hold Active</p> <p>Depress Brake and Switch to Deactivate</p>	<p>Indicates that the brake hold system cannot be turned off A buzzer also sounds. → Depress the brake pedal.</p>
<p>Brake Hold Unavailable</p> <p>Driver Door Open</p> <p>Brake Hold Unavailable</p> <p>Driver Seat Belt Unbuckled</p>	<p>Indicates that the brake hold system is not available The reason the brake hold system is not available may be displayed. A buzzer also sounds. → Close the driver's door. → Fasten the driver's seat belt.</p>
<p>Depress Brake to Maintain Brake Hold</p> <p>Close Driver Door to Maintain Brake Hold</p> <p>Fasten Driver Seat Belt to Maintain Brake Hold</p>	<p>Indicates that the brake hold system is unable to continue brake hold function The reason the brake hold system is not continue may be displayed. A buzzer also sounds. → Depress the brake pedal. → Close the driver's door. → Fasten the driver's seat belt.</p>



Warning message	Details/Actions
<p data-bbox="395 495 651 629">Warming Up Maximum Vehicle Speed: 110km/h</p> 	<p data-bbox="675 539 1233 651">Indicates that the vehicle is unable to drive over 110 km/h (65 mph) until the transmission warms up A buzzer also sounds. → Wait until the transmission warms up.</p>
<p data-bbox="395 741 651 943">Parking Brake Activated</p> <p data-bbox="395 864 651 943">Release before Driving</p>	<p data-bbox="675 786 1233 875">Indicates that the parking brake is set automatically while the brake hold system is holding the brakes A buzzer also sounds. → Release the parking brake.</p>
 <p data-bbox="395 1066 651 1267">Drive-Start Control Malfunction</p> <p data-bbox="395 1223 651 1267">Visit Your Dealer</p> 	<p data-bbox="675 1111 1233 1245">Indicates a malfunction in the Drive-Start Control system A buzzer also sounds. → Have the vehicle inspected by any authorized Lexus retailer or Lexus authorized repairer, or any reliable repairer.</p>
 <p data-bbox="395 1514 651 1592">Brake Override Malfunction</p> <p data-bbox="395 1637 651 1682">Visit Your Dealer</p> 	<p data-bbox="675 1547 1233 1682">Indicates a malfunction in the brake override system A buzzer also sounds. → Have the vehicle inspected by any authorized Lexus retailer or Lexus authorized repairer, or any reliable repairer.</p>



Warning message	Details/Actions
<p data-bbox="395 495 651 584">Engine Oil Level Low</p> <p data-bbox="395 618 651 674">Add or Replace</p>	<p data-bbox="675 506 1235 640">Indicates that engine oil level is low This message may appear if the vehicle is stopped on a slope. Move the vehicle to a level surface and check to see if the message disappears. A buzzer also sounds.</p> <p data-bbox="675 640 1235 674">→ Check the level of engine oil, and add if necessary.</p>
<p data-bbox="395 719 651 808">Hybrid System Overheated</p> <p data-bbox="395 842 651 931">Reduced Output Power</p>	<p data-bbox="675 741 1235 875">Indicates that the hybrid system has overheated This message may be displayed when driving under severe operating conditions. (For example, when driving up a long steep hill.) A buzzer also sounds.</p> <p data-bbox="675 875 1235 909">→ Stop and check. (→P. 535)</p>
<p data-bbox="395 976 651 1066">Headlight System Malfunction</p> <p data-bbox="395 1099 651 1155">Visit Your Dealer</p> 	<p data-bbox="675 965 1235 1178">Indicates a malfunction in:</p> <ul data-bbox="699 987 1235 1155" style="list-style-type: none"> • The AHS (Adaptive High-beam System) (if equipped); • The Automatic High Beam (if equipped); • The AFS (Adaptive Front-lighting System) (if equipped); or • The LED headlight system <p data-bbox="699 1155 1235 1178">A buzzer also sounds.</p> <p data-bbox="675 1178 1235 1256">→ Have the vehicle inspected by any authorized Lexus retailer or Lexus authorized repairer, or any reliable repairer.</p>
<p data-bbox="395 1290 651 1379">Check RSA System</p>  <p data-bbox="483 1469 563 1491">(If equipped)</p>	<p data-bbox="675 1312 1235 1368">Indicates a malfunction in the RSA (Road Sign Assist) A buzzer also sounds</p> <p data-bbox="675 1368 1235 1447">→ Have the vehicle inspected by any authorized Lexus retailer or Lexus authorized repairer, or any reliable repairer.</p>

Warning message	Details/Actions
 <p>Accelerator and Brake Pedals Depressed Simultaneously</p>  <p>(Flashes)</p>	<p>Indicates that the accelerator and brake pedals are being depressed simultaneously, and the brake override system is operating. → Release the accelerator or brake pedal. (→P. 201)</p>
 <p>Tire Pressure [bar]</p> <p>2.4 1.6</p> <p>2.4 2.4</p>  <p>(If equipped)</p>	<p>Indicates that the tire inflation pressure is low → Check the tire inflation pressure, and adjust to the appropriate level.</p>

Warning message	Details/Actions
 <p>Tire Pressure</p>  <p>(If equipped)</p>	<p>Indicates a malfunction in the tire pressure warning system</p> <p>→ Stop the vehicle in a safe place and turn the power switch off then on again. If the tire pressure warning indicator flashes for 1 minute then illuminates, there is a malfunction in the system. Have the vehicle inspected by any authorized Lexus retailer or Lexus authorized repairer, or any reliable repairer.</p>
 <p>Tire Pressure [bar]</p> <p>(If equipped)</p>	<p>Indicates that the tire position information cannot be recognized</p> <p>→ Drive for a short while and check if the display updates.</p> <p>If the radio wave conditions improve, the display may return to normal. If the tire pressure is still not displayed after driving for several minutes, stop the vehicle in a safe place, turn the power switch off then on again, and start driving. If the tire pressure is still not displayed even after repeating this process several times, have the vehicle inspected by any authorized Lexus retailer or Lexus authorized repairer, or any reliable repairer.</p>
<p>Windshield Washer Fluid Low</p>	<p>Indicates that the washer fluid level is low</p> <p>→ Add washer fluid.</p>
<p>Fuel Low</p>	<p>Indicates that remaining fuel is approximately 9.9 L (2.6 gal., 2.2 Imp.gal.) or less</p> <p>→ Refuel the vehicle.</p>

Warning message	Details/Actions
 <p>Roads May Be Icy</p> <p>Drive with Care</p>	<p>Indicates that the outside temperature is approximately 3°C (37°F) or lower A buzzer also sounds. → Drive carefully, as the road may be icy.</p>
<p>Oil Maintenance Required Soon</p>	<p>Indicates that the engine oil is scheduled to be changed → Check the engine oil and change if necessary. After changing the engine oil, the oil change system should be reset. (→P. 406) (The indicator will not work properly unless the oil maintenance data has been reset.)</p>
<p>Injector Maintenance Required Soon</p>  <p>(If equipped)</p>	<p>Indicates that the fuel injectors require maintenance soon → Have any authorized Lexus retailer or Lexus authorized repairer, or any reliable repairer replenish the injector cleaner to the fuel tank and reset the message as necessary.</p>
<p>Oil Maintenance Required</p>	<p>Indicates that the engine oil and oil filter should be changed → Have the engine oil and oil filter checked and/or changed by any authorized Lexus retailer or Lexus authorized repairer, or any reliable repairer. After changing the engine oil, the oil change system should be reset. (→P. 406)</p>
<p>Injector Maintenance Required</p> <p>Visit Your Dealer</p>  <p>(If equipped)</p>	<p>Indicates that the fuel injectors require maintenance → Have any authorized Lexus retailer or Lexus authorized repairer, or any reliable repairer replenish the injector cleaner and reset the message.</p>

Warning message	Details/Actions
<p data-bbox="395 495 651 674">To Activate Auto High Beam, Switch Headlights to High Beam</p> <p data-bbox="483 685 563 707">(If equipped)</p>	<p data-bbox="675 539 1235 651">Indicates that the Automatic High Beam switch was pressed while the low beams were on → Turn the high beam headlights on before pressing the Automatic High Beam switch.</p>
<p data-bbox="395 734 651 898">To Activate AHS, Switch Headlights to High Beam</p> <p data-bbox="483 909 563 931">(If equipped)</p>	<p data-bbox="675 768 1235 880">Indicates that the Adaptive High-beam System switch was pressed while the low beams were on → Turn the high beam headlights on before pressing the Adaptive High-beam System switch.</p>
<p data-bbox="395 958 651 1122">VSC Turned Off Pre-Crash Brake System Unavailable</p>  <p data-bbox="483 1223 563 1245">(If equipped)</p>	<p data-bbox="675 1025 1235 1160">Indicates that, since the VSC (Vehicle Stability Control) system was turned off, the pre-crash braking and pre-crash brake assist are stopped (The pre-crash warning function will be operational) → Turn the VSC on. (→P. 327)</p>
<p data-bbox="395 1272 651 1361">Pre-Crash Safety Unavailable</p>  <p data-bbox="411 1451 467 1473">(Flashes)</p> <p data-bbox="483 1485 563 1507">(If equipped)</p>	<p data-bbox="675 1272 1235 1350">Indicates that the PCS (Pre-Crash Safety system) is temporarily unavailable A buzzer also sounds.</p> <p data-bbox="675 1350 1235 1485">→ When conditions improve, the system resumes operation. If this item is displayed continuously, have the vehicle inspected by any authorized Lexus retailer or Lexus authorized repairer, or any reliable repairer.</p>

Warning message	Details/Actions
<p>High Power Consumption</p> <p>Partial Limit On AC/Heater Operation</p>  <p>(Flashes)</p>	<p>Air conditioning, heater and other operations are temporarily limited due to high power consumption</p> <p>→ Turn off unnecessary electronic equipment to reduce power consumption.</p> <p>Please wait until the power supply returns to normal.</p> <p>If this item is frequently displayed, have the vehicle inspected by any authorized Lexus retailer or Lexus authorized repairer, or any reliable repairer immediately.</p>
<p>Pre-Crash Safety Unavailable</p> <p>Clean Sensor</p>  <p>(Flashes)</p> <p>(If equipped)</p>	<p>Indicates that part of the PCS (Pre-Crash Safety system) sensor is dirty, covered with ice, etc.</p> <p>A buzzer also sounds.</p> <p>→ Remove any dirt, ice, etc.</p>

Other displayed messages

Carrying out the corresponding action turns the messages off.

Warning message	Details/Actions
<p>Maintenance Required for Hybrid Battery Cooling Parts at Your Dealer</p>	<p>Maintenance of the hybrid battery (traction battery) cooling component is required</p> <p>The filter may be clogged, the air intake vent may be blocked or there may be a gap in the duct.</p> <p>→ Have maintenance performed on the hybrid battery (traction battery) cooling component at any authorized Lexus retailer or Lexus authorized repairer, or any reliable repairer.</p>

7

When trouble arises

Warning message	Details/Actions
EV Mode Unavailable	<p data-bbox="671 920 1243 1137"> Indicates that the EV drive mode is not available* The reason the EV drive mode is not available (the vehicle is idling, battery charge is low, speed is higher than the EV drive mode operating speed range, accelerator pedal is depressed too much) may be displayed. A buzzer also sounds. → Use the EV drive mode when it becomes available. </p>
EV Mode Unavailable	
System Warming Up	
EV Mode Unavailable Hybrid Battery Low	
EV Mode Unavailable Speed Range Exceeded	
EV Mode Unavailable Reduce Acceleration to Activate	

*: For the EV drive mode operating conditions (→P. 222).

Warning message	Details/Actions
<p>EV Mode Deactivated</p>	<p>Indicates that the EV drive mode has been automatically canceled* The reason the EV drive mode is not available (the battery charge is low, speed is higher than the EV drive mode operating speed range, accelerator pedal is depressed too much) may be displayed. A buzzer also sounds. → Drive the vehicle for a while.</p>
<p>EV Mode Deactivated</p>	
<p>Hybrid Battery Low</p>	
<p>EV Mode Deactivated</p> <p>Speed Range Exceeded</p>	
<p>EV Mode Deactivated</p> <p>Accelerator Depressed Too Far</p>	
<p> (Flashes)</p>	

*: For the EV drive mode operating conditions (→P. 222).

■ **Warning message in radar cruise mode (if equipped)**

In the following cases, the warning message may not be displayed even if vehicle-to-vehicle distance decreases:



- When your vehicle and the vehicle ahead are traveling at the same speed or the vehicle ahead is traveling more quickly than your vehicle
- When the vehicle ahead is traveling at a very low speed
- Immediately after cruise control speed is set
- At the instant the accelerator pedal is depressed



■ **Open door warning message**

The open door warning message continues to display until a door or the trunk is fully closed, even if the power switch is turned off. However, approximately 20 minutes after a door or the trunk is not fully closed, the 12-volt battery-saving function operates and the display turns off even though a door or the trunk is not fully closed.







■ **Warning buzzer**



In some cases, the buzzer may not be heard because of noisy place or an audio sound.

Interior buzzer	Exterior buzzer	Warning message	Details/Actions
Once	—	<p>Key Not Detected</p> <p>Check Key Location</p>  <p>(Flashes)</p>	<p>The electronic key is not detected when an attempt is made to start the hybrid system.</p> <p>→ Start the hybrid system with the electronic key present.</p>
Once	3 times	<p>Key Not Detected</p> <p>Check Key Location</p>  <p>(Flashes)</p>	<p>The electronic key was carried outside the vehicle and a door other than the driver's door was opened and closed while the power switch was in a mode other than off.</p> <p>→ Bring the electronic key back into the vehicle.</p> <p>The driver's door was opened and closed while the electronic key was not in the vehicle, the shift lever was in P and the power switch was not turned off.</p> <p>→ Turn the power switch off or bring the electronic key back into the vehicle.</p>
Once	Continuous	<p>Key Not Detected</p> <p>Check Key Location</p> <hr/> <p>Turn Off Vehicle</p> <p>(Displayed alternately)</p>  <p>(Flashes)</p>	<p>An attempt was made to exit the vehicle with the electronic key and lock the doors without first turning the power switch off when the shift lever was in P.</p> <p>→ Turn the power switch off and lock the doors again.</p>

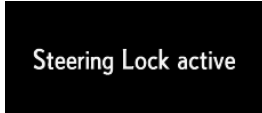
Interior buzzer	Exterior buzzer	Warning message	Details/Actions
9 times	—	<div style="background-color: black; color: white; padding: 5px; text-align: center;"> Key Not Detected Check Key Location </div>  <p>(Flashes)</p>	<p>An attempt was made to drive when the regular key was not inside the vehicle. → Confirm that the electronic key is inside the vehicle.</p>
Continuous	—	<div style="background-color: black; color: white; padding: 5px; text-align: center;"> Shift to P Before Exiting Vehicle </div>  <p>(Flashes)</p>	<p>The driver's door was opened when the shift lever was not in P and the power switch was not turned off. → Shift the shift lever to P.</p>
Continuous	Continuous	<div style="background-color: black; color: white; padding: 5px; text-align: center;"> Shift to P Before Exiting Vehicle </div> <hr/> <div style="background-color: black; color: white; padding: 5px; text-align: center;"> Key Not Detected Check Key Location </div> <p>(Displayed alternately)</p>  <p>(Flashes)</p>	<p>The driver's door was opened and closed while the electronic key was not in the vehicle, the shift lever was not in P and the power switch was not turned off. → Shift the shift lever to P. → Bring the electronic key back into the vehicle.</p>

Interior buzzer	Exterior buzzer	Warning message	Details/Actions
—	Con- tinuous	<div style="background-color: black; color: white; padding: 5px; text-align: center;"> Key Left inside Vehicle </div> <p>(Vehicles with the entry function)</p>	<p>An attempt was made to lock the doors using the smart entry & start system while the electronic key was still inside the vehicle. → Retrieve the electronic key from the vehicle and lock the doors again.</p>
Once	Con- tinuous	<div style="background-color: black; color: white; padding: 5px; text-align: center;"> Key Left inside Vehicle </div>	<p>An attempt was made to lock either front door by opening a door and putting the inside lock button into the lock position, then closing the door by pulling on the outside door handle with the electronic key still inside the vehicle. For some models only: An attempt was made to lock the doors other than using the smart entry & start system while the electronic key was still inside the vehicle. → Retrieve the electronic key from the vehicle and lock the doors again.</p>
Once	—	<div style="background-color: black; color: white; padding: 5px; text-align: center;"> Depress Brake and Then Touch Key to Power Switch </div>	<ul style="list-style-type: none"> • When the doors were unlocked with the mechanical key and then the power switch was pressed, the electronic key could not be detected in the vehicle. • The electronic key could not be detected in the vehicle even after the power switch was pressed two consecutive times. <p>→ Touch the electronic key to the power switch while depressing the brake pedal.</p>
Once	—	<div style="background-color: black; color: white; padding: 5px; text-align: center;"> Shift to P position to Start </div> <div style="text-align: center;">  (Flashes) </div>	<p>An attempt was made to start the hybrid system with the shift lever in an incorrect position. → Shift the shift lever to P and start the hybrid system.</p>

Interior buzzer	Exterior buzzer	Warning message	Details/Actions
—	—		<p>Power was turned off due to the automatic power off function.</p> <p>→ Next time when starting the hybrid system, operate the hybrid system for approximately 5 minutes to recharge the 12-volt battery.</p>
Once	—	 	<p>The electronic key has a low battery.</p> <p>→ Replace the electronic key battery. (→P. 435)</p>
Once	—		<p>The driver's door was opened and closed with the power switch turned off and then the power switch was put in ACCESSORY mode twice without the hybrid system being started.</p> <p>→ Press the power switch while depressing the brake pedal.</p> <p>During an hybrid system starting procedure in the event that the electronic key was not functioning properly (→P. 528), the power switch was touched with the electronic key.</p> <p>→ Press the power switch within 10 seconds of the buzzer sounding.</p>
Once	—	  (Flashes)	<p>The steering lock could not be released within 3 seconds of the power switch being pressed.</p> <p>→ Press the power switch while depressing the brake pedal and moving the steering wheel left and right.</p>

Interior buzzer	Exterior buzzer	Warning message	Details/Actions
Once	—	<div style="background-color: black; color: white; padding: 5px; text-align: center;"> Shift to P Before Exiting Vehicle </div>  <p>(Flashes)</p>	<p>The power switch has been turned off with the shift lever in a position other than P or N. → Shift the shift lever to P.</p>
Once	—	<div style="background-color: black; color: white; padding: 5px; text-align: center;"> Turn Off Vehicle </div>  <p>(Flashes)</p>	<p>After the power switch has been turned off with the shift lever in a position other than P, the shift lever has been shifted to P. → Turn the power switch off.</p>

■ **Warning buzzer**

In some cases, the buzzer may not be heard because of noisy place or an audio sound.

If you have a flat tire (vehicles with spare tire)

Your vehicle is equipped with a spare tire. The flat tire can be replaced with the spare tire.

For details about tires: →P. 416

WARNING

■ If you have a flat tire

Do not continue driving with a flat tire.
Driving even a short distance with a flat tire can damage the tire and the wheel beyond repair, which could result in an accident.

Before jacking up the vehicle

- Stop the vehicle in a safe place on a hard, flat surface.
- Set the parking brake.
- Shift the shift lever to P.
- Stop the hybrid system.
- Turn on the emergency flashers. (→P. 452)

Location of the spare tire, jack and tools

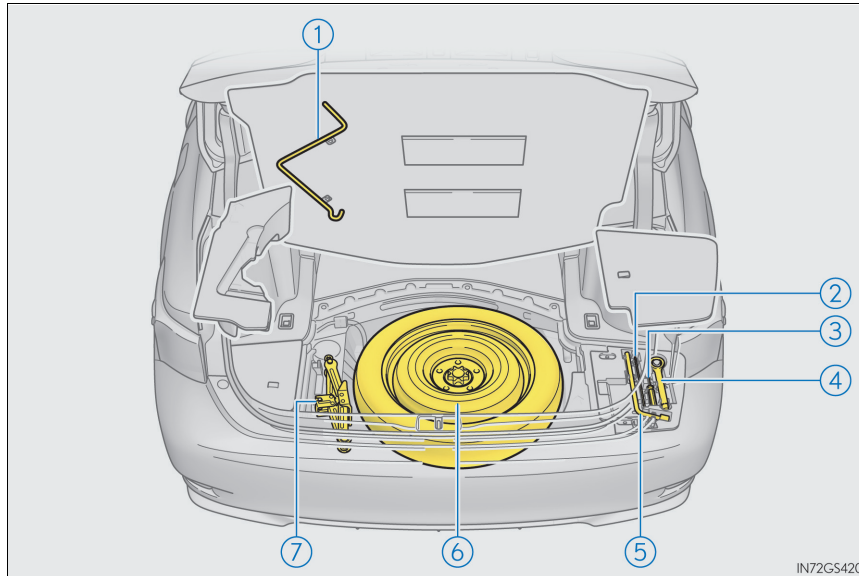

- ① Jack handle
- ② Parking brake release tool
- ③ Screwdriver
- ④ Towing eyelet
- ⑤ Wheel nut wrench
- ⑥ Spare tire
- ⑦ Jack

 **WARNING**

■ **Using the tire jack**

Observe the following precautions.

Improper use of the tire jack may cause the vehicle to suddenly fall off the jack, leading to death or serious injury.

- Do not use the tire jack for any purpose other than replacing tires or installing and removing tire chains.
- Only use the tire jack that comes with this vehicle for replacing a flat tire. Do not use it on other vehicles, and do not use other tire jacks for replacing tires on this vehicle.
- Put the jack properly in its jack point.
- Do not put any part of your body under the vehicle while it is supported by the jack.
- Do not start the hybrid system or drive the vehicle while the vehicle is supported by the jack.
- Do not raise the vehicle while someone is inside.
- When raising the vehicle, do not put an object on or under the jack.
- Do not raise the vehicle to a height greater than that required to replace the tire.
- Use a jack stand if it is necessary to get under the vehicle.
- When lowering the vehicle, make sure that there is no-one near the vehicle. If there are people nearby, warn them vocally before lowering.

Taking out the jack and jack handle

- 1 Remove the center luggage mat. (→P. 375)
- 2 Remove the spacer and take out the jack handle from the reverse side of the center luggage mat.

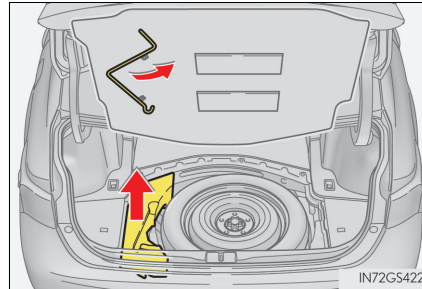

- 3 Take out the jack.
 - ① For tightening
 - ② For loosening

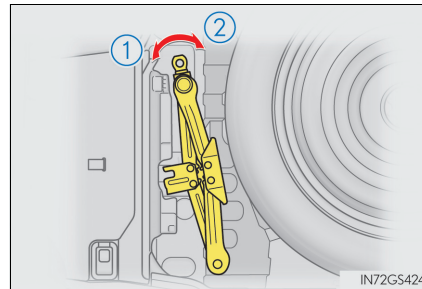

Taking out the spare tire

- 1 Remove the center luggage mat. (→P. 375)
- 2 Loosen the center fastener that secures the spare tire.

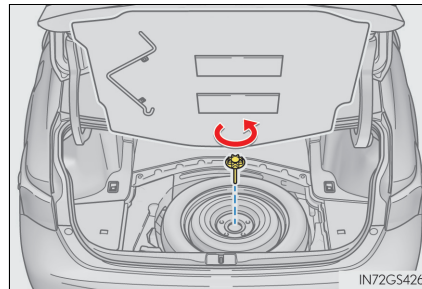

⚠ WARNING

■ When storing the spare tire

Be careful not to catch fingers or other body parts between the spare tire and the body of the vehicle.

Replacing a flat tire

- 1 Check the tires.

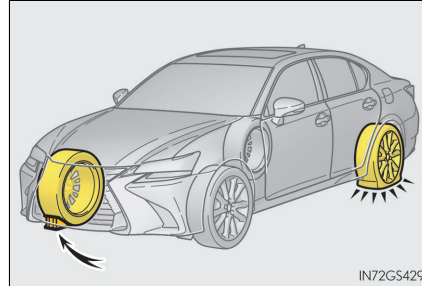

Flat tire		Wheel chock positions
Front	Left-hand side	Behind the rear right-hand side tire
	Right-hand side	Behind the rear left-hand side tire
Rear	Left-hand side	In front of the front right-hand side tire
	Right-hand side	In front of the front left-hand side tire

- 2 Slightly loosen the wheel nuts (one turn).

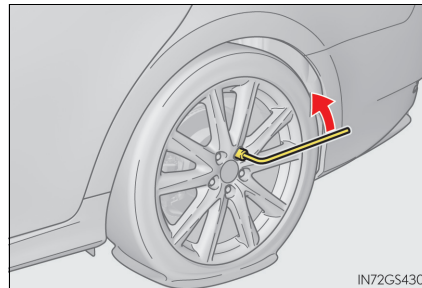

- 3 Turn the tire jack portion "A" by hand until the notch of the jack is in contact with the jack point.

The jack point guides are located under the rocker panel. They indicate the jack point positions.

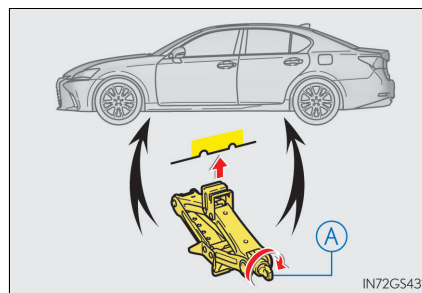

- 4 Raise the vehicle until the tire is slightly raised off the ground.

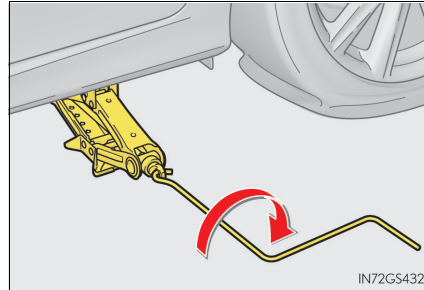

- 5 Remove all the wheel nuts and the tire.

When resting the tire on the ground, place the tire so that the wheel design faces up to avoid scratching the wheel surface.

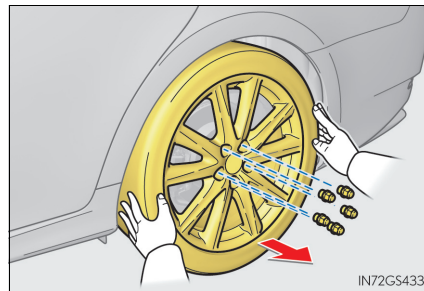

⚠ WARNING

■ Replacing a flat tire

- Do not touch the disc wheels or the area around the brakes immediately after the vehicle has been driven. After the vehicle has been driven the disc wheels and the area around the brakes will be extremely hot. Touching these areas with hands, feet or other body parts while changing a tire, etc. may result in burns.
- Failure to follow these precautions could cause the wheel nuts to loosen and the tire to fall off, resulting in death or serious injury.
 - Never use oil or grease on the wheel bolts or wheel nuts. Oil and grease may cause the wheel nuts to be excessively tightened, leading to bolt or disc wheel damage. In addition, the oil or grease can cause the wheel nuts to loosen and the wheel may fall off, causing a serious accident. Remove any oil or grease from the wheel bolts or wheel nuts.
 - Have the wheel nuts tightened with a torque wrench to 103 N•m (10.5 kgf•m, 76 ft•lbf) as soon as possible after changing wheels.
 - When installing a tire, only use wheel nuts that have been specifically designed for that wheel.
 - If there are any cracks or deformations in the bolt screws, nut threads or bolt holes of the wheel, have the vehicle inspected by any authorized Lexus retailer or Lexus authorized repairer, or any reliable repairer.

Installing the spare tire

- 1 Remove any dirt or foreign matter from the wheel contact surface.

If foreign matter is on the wheel contact surface, the wheel nuts may loosen while the vehicle is in motion, causing the tire to come off.

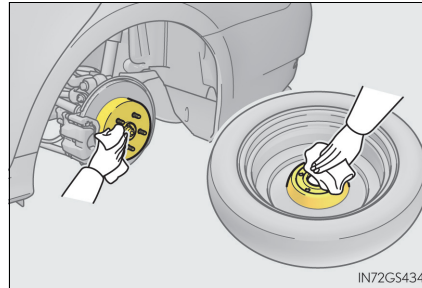

- 2 Install the tire and loosely tighten each wheel nut by hand by approximately the same amount.

When replacing an aluminum wheel with a steel wheel, tighten the wheel nuts until the tapered portion comes into loose contact with the disc wheel seat.

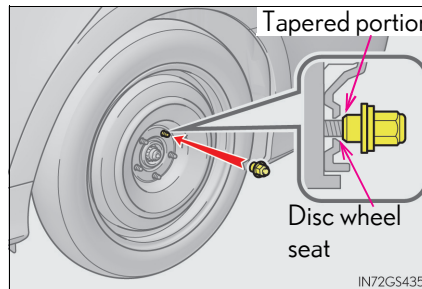

When replacing an aluminum wheel with an aluminum wheel, turn the wheel nuts until the washers come into contact with the disc wheel.

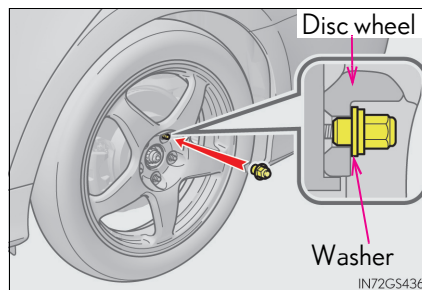

- 3 Lower the vehicle.

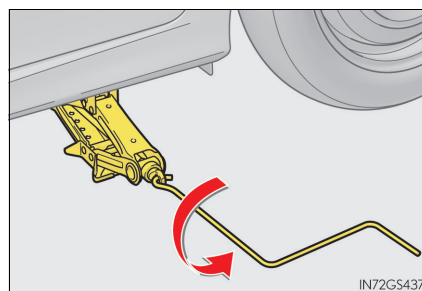

- 4 Firmly tighten each wheel nut two or three times in the order shown in the illustration.

Tightening torque:
103 N•m (10.5 kgf•m, 76 ft•lbf)

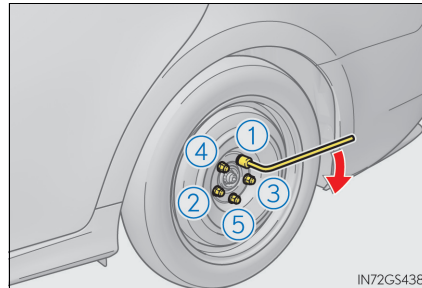

- 5 Stow the flat tire, tire jack and all tools.

■ The compact spare tire

- The compact spare tire is identified by the label "TEMPORARY USE ONLY" on the tire sidewall.
- Use the compact spare tire temporarily, and only in an emergency.
- Make sure to check the tire inflation pressure of the compact spare tire. (→P. 555)

■ When using the compact spare tire (vehicles with the tire pressure warning system)

As the compact spare tire is not equipped with a tire pressure warning valve and transmitter, low inflation pressure of the spare tire will not be indicated by the tire pressure warning system. Also, if you replace the compact spare tire after the tire pressure warning light comes on, the light remains on.

■ When the compact spare tire is equipped

The vehicle may become lower when driving with the compact spare tire compared to when driving with standard tires.

■ If you have a flat rear tire on a road covered with snow or ice (vehicles with front and rear tires of the same size and compact spare tire only)

Install the compact spare tire on one of the front wheels of the vehicle. Perform the following steps and fit tire chains to the rear tires:

- 1 Replace a front tire with the compact spare tire.
- 2 Replace the flat rear tire with the tire removed from the front of the vehicle.
- 3 Fit tire chains to the rear tires.

■ Certification for the jack



Manufacturer's Declaration of Conformity

Manufacturer:
Kawasaki Industrial Co., Ltd.
4618 Mukaijima Shimada, Shizuoka, Japan

The EU Directives covered by this Declaration

2006/42/EC Machinery Directive

The product covered by this declaration

JACK SUB-ASSY,PANTOGRAPH

model

0.8ton , 1.1ton , 1.35ton , 1.5ton

The basis on which conformity is being declared

The product identified above complies with the requirements of
the Machinery Directive
Directive above by meeting following standards

JIS D 8103

The technical documentation required to demonstrate that the product
meets the requirement the Machinery Directive has been compiled by
the signatory below and is available for inspection by the relevant
enforcement authorities.

A sample of the product has been tested by the manufacturer

Technical File No: KSF-201-00-01

The CE mark was first applied in:2010

Done at Shizuoka, Japan

Signature:

A handwritten signature in black ink, appearing to read 'Koji Kawasaki', written over a horizontal line.

Koji Kawasaki
PRESIDENT ,Kawasaki Industrial Co., Ltd.

Date of Issue: 25 December,2009

 **WARNING**
■ When using the compact spare tire

- Remember that the compact spare tire provided is specifically designed for use with your vehicle. Do not use your compact spare tire on another vehicle.
- Do not use more than one compact spare tire simultaneously.
- Replace the compact spare tire with a standard tire as soon as possible.
- Avoid sudden acceleration, abrupt steering, sudden braking and shifting operations that cause sudden engine braking.

■ When the compact spare tire is attached

The vehicle speed may not be correctly detected, and the following systems may not operate correctly:

- | | |
|--|---|
| • ABS & Brake assist | • Adaptive Variable Suspension system (if equipped) |
| • VSC | • LKA (Lane-Keeping Assist) (if equipped) |
| • TRC | • Tire pressure warning system (if equipped) |
| • Cruise control (if equipped) | • VDIM |
| • Dynamic radar cruise control with full-speed range (if equipped) | • VGRS (if equipped) |
| • (Pre-Crash Safety system) (if equipped) | • Lexus parking assist monitor (if equipped) |
| • EPS | • Lexus parking assist-sensor (if equipped) |
| • AFS (if equipped) | • Navigation system (if equipped) |
| • LDH (if equipped) | |
| • DRS (if equipped) | |

■ Speed limit when using the compact spare tire

Do not drive at speeds in excess of 80 km/h (50 mph) when a compact spare tire is installed on the vehicle.

The compact spare tire is not designed for driving at high speeds. Failure to observe this precaution may lead to an accident causing death or serious injury.

■ After using the tools and jack

Before driving, make sure all the tools and jack are securely in place in their storage location to reduce the possibility of personal injury during a collision or sudden braking.



NOTICE

- **Be careful when driving over bumps with the compact spare tire installed on the vehicle.**

The vehicle may become lower when driving with the compact spare tire compared to when driving with standard tires. Be careful when driving over uneven road surfaces.

- **Driving with tire chains and the compact spare tire**

Do not fit tire chains to the compact spare tire.

Tire chains may damage the vehicle body and adversely affect driving performance.

- **When replacing the tires (vehicles with the tire pressure warning system)**

When removing or fitting the wheels, tires or the tire pressure warning valve and transmitter, contact any authorized Lexus retailer or Lexus authorized repairer, or any reliable repairer as the tire pressure warning valve and transmitter may be damaged if not handled correctly.

If you have a flat tire (vehicles without spare tire)

Your vehicle is not equipped with a spare tire, but instead is equipped with an emergency tire puncture repair kit.

A puncture caused by a nail or screw passing through the tire tread can be repaired temporarily with the emergency tire puncture repair kit.

WARNING

■ If you have a flat tire

Do not continue driving with a flat tire.

Driving even a short distance with a flat tire can damage the tire and the wheel beyond repair, which could result in an accident.

Driving with a flat tire may cause a circumferential groove on the side wall.

In such a case, the tire may explode when using a repair kit.

Before repairing the vehicle

- Stop the vehicle in a safe place on a hard, flat surface.
- Set the parking brake.
- Shift the shift lever to P.
- Stop the hybrid system.
- Turn on the emergency flashers. (→P. 452)
- Check the degree of the tire damage.

A tire should only be repaired with the emergency tire puncture repair kit if the damage is caused by a nail or screw passing through the tire tread.

- Do not remove the nail or screw from the tire. Removing the object may widen the opening and disenable emergency repair with the kit.
- To avoid sealant leakage, move the vehicle until the area of the puncture, if known, is positioned at the top of the tire.

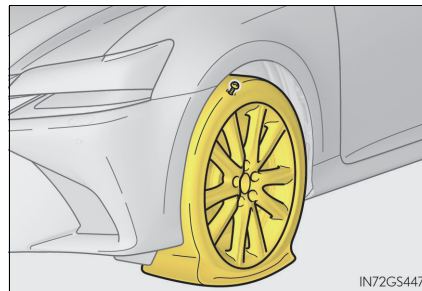
**■ A flat tire that cannot be repaired with the emergency tire puncture repair kit**

In the following cases, the tire cannot be repaired with the emergency tire puncture repair kit. Contact any authorized Lexus retailer or Lexus authorized repairer, or any reliable repairer.

- When the tire is damaged due to driving without sufficient air pressure
- When the tire lost air pressure due to a crack or damage in the tire sidewall
- When the tire is visibly separated from the wheel
- When the cut or damage to the tread is 4 mm (0.16 in.) long or more
- When the wheel is damaged
- When two or more tires have been punctured
- When there is more than one hole or cut in the damaged tire
- When the sealant has expired

Location of the emergency tire puncture repair kit, jack and tools

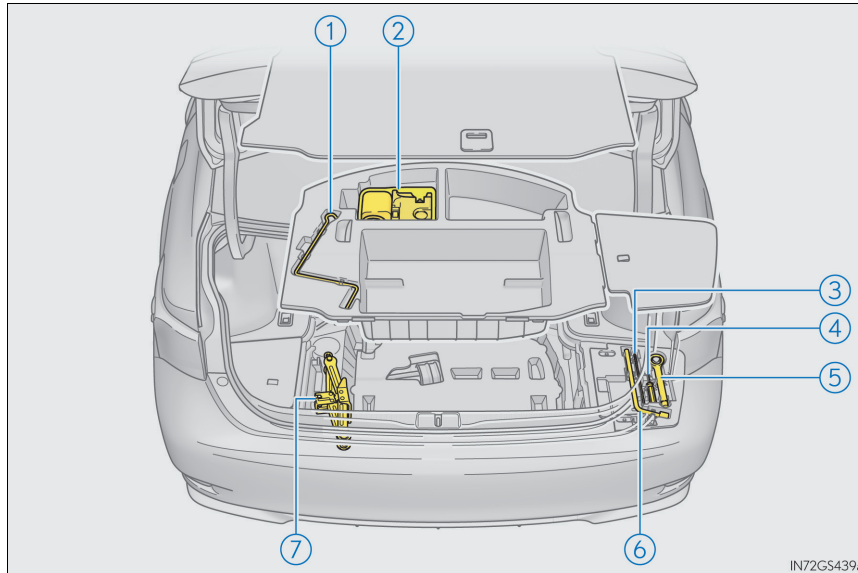

- ① Jack handle
- ② Emergency tire puncture repair kit
- ③ Parking brake release tool
- ④ Screwdriver
- ⑤ Towing eyelet
- ⑥ Wheel nut wrench
- ⑦ Jack*

*: Use of the jack (→P. 502)

Emergency tire puncture repair kit components

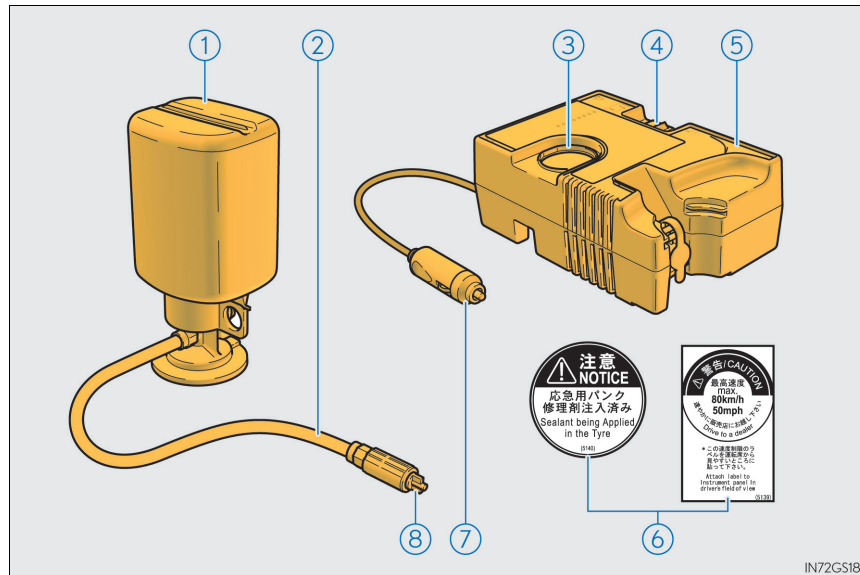

- | | |
|----------------------|-------------------|
| ① Bottle | ⑤ Compressor |
| ② Hose | ⑥ Stickers |
| ③ Air pressure gauge | ⑦ Power plug |
| ④ Compressor switch | ⑧ Air release cap |

IN72GS181

Taking out the emergency tire puncture repair kit

- 1 Remove the center luggage mat. (→P. 375)
- 2 Take out the emergency tire puncture repair kit.

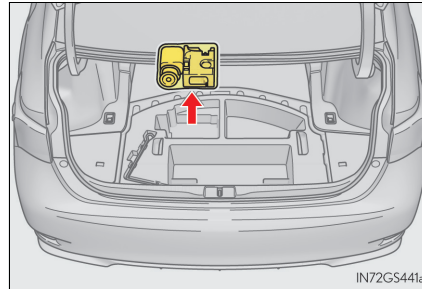

Taking out the jack

- 1 Remove the center luggage mat. (→P. 375)
- 2 Remove the center auxiliary box.

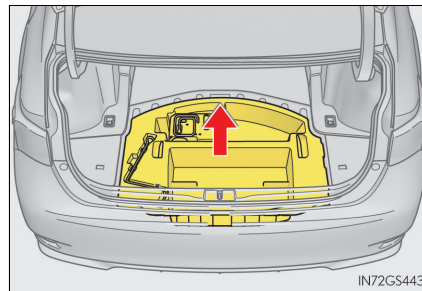

- 3 Take out the jack.
 - ① For tightening
 - ② For loosening

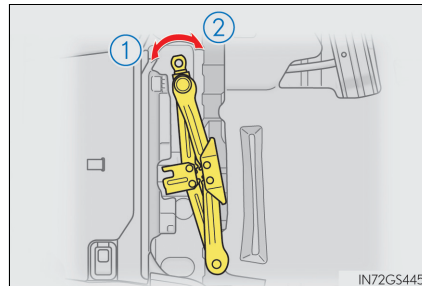

Emergency repair method

- 1 Remove the valve cap from the valve of the punctured tire.

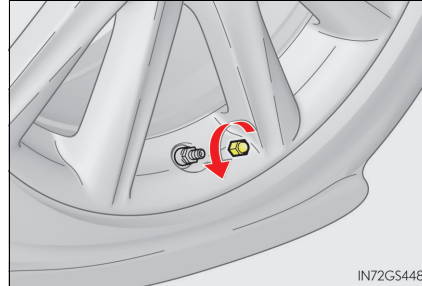

- 2 Remove the air release cap from the hose.

You will use the air release cap again. Therefore keep it in a safe place.

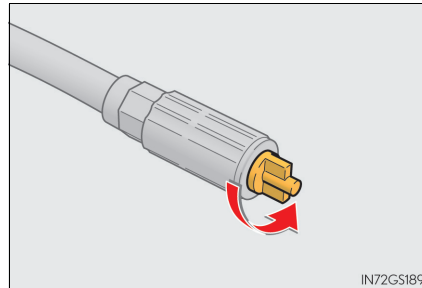

- 3 Connect the hose to the valve.
Screw the end of the hose clockwise as far as possible.

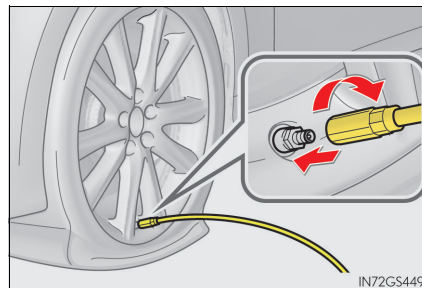

- 4 Make sure that the compressor switch is off.

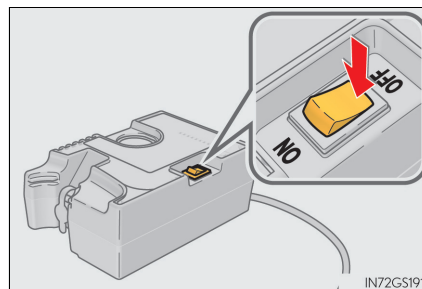

- 5** Remove the rubber stopper from the compressor.

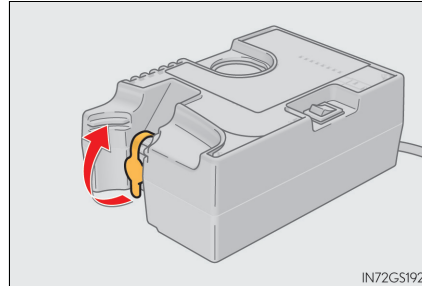

- 6** Connect the power plug to the power outlet socket.

► Inside of console box

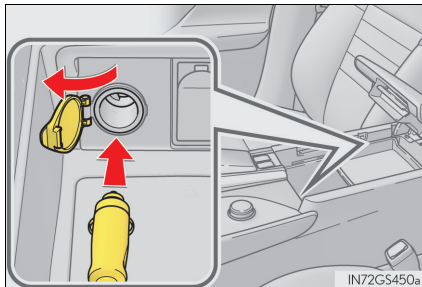

► Backside of console box

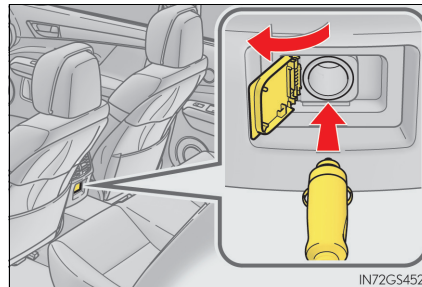

- 7** Connect the bottle to the compressor.

Connect by inserting the bottle straight into the compressor, and make sure that the protruding part of the bottle is properly aligned with the groove in the case.

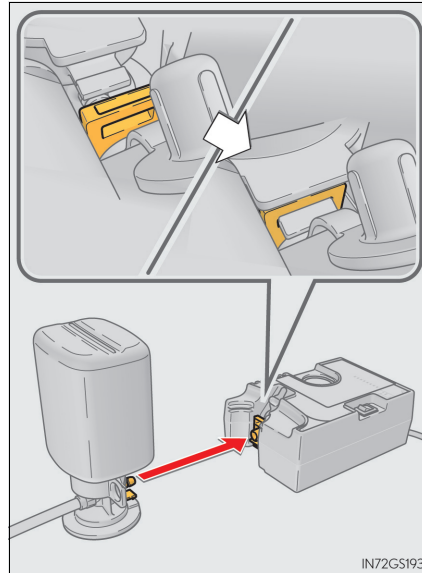

- 8** Attach the 2 stickers as shown.

Remove any dirt and moisture from the wheel before attaching the sticker.

If you are unable to apply the stickers, inform the nearest any authorized Lexus retailer or Lexus authorized repairer, or any reliable repairer that sealant has been applied to the puncture when having the tire repaired or replaced.

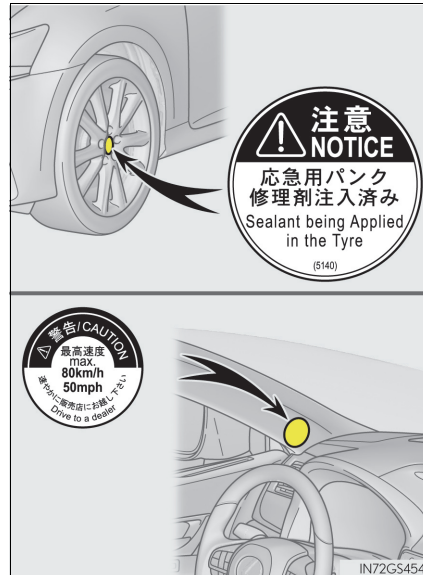

- 9** Check the specified tire inflation pressure.

Tire inflation pressure is specified on the label as shown. (→P. 555)

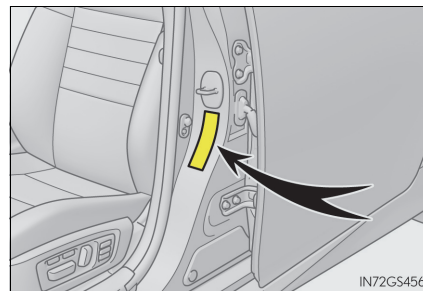

- 10** Start the hybrid system. (→P. 217)

- 11** To inject the sealant and inflate the tire, turn the compressor switch on.

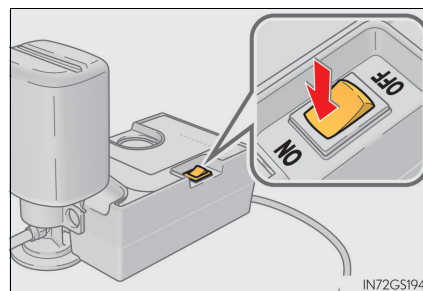

12 Inflate the tire until the recommended pressure is reached.

① The sealant will be injected and the pressure will spike to 300 kPa (3.0 kgf/cm² or bar, 44 psi) or 400 kPa (4.0 kgf/cm² or bar, 58 psi), and then gradually decrease.

② The air pressure gauge will display the actual tire inflation pressure about 1 minute (15 minutes at low temperature) after the switch is turned on.

③ Inject to recommended pressure.

- Turn the compressor switch off and then check the tire inflation pressure. Being careful not to over inflate, check and repeat the inflation procedure until the specified tire inflation pressure is reached.
- If the tire inflation pressure is still lower than the specified point after inflation for 10 minutes (35 minutes at low temperature) with the switch on, the tire is too damaged to be repaired. Turn the compressor switch off and contact any authorized Lexus retailer or Lexus authorized repairer, or any reliable repairer.
- If the tire inflation pressure exceeds the recommended level, let out some air to adjust the tire inflation pressure. (→P. 520, 555)

13 With the compressor switch off, disconnect the hose from the valve on the tire and then pull out the power plug from the power outlet socket.

Some sealant may leak when the hose is removed.

14 Install the valve cap onto the valve of the emergency repaired tire.

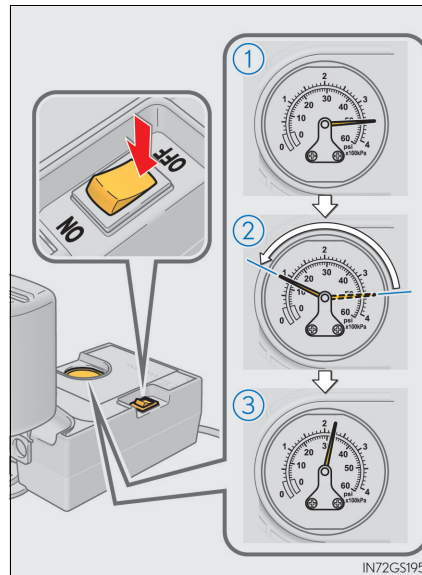

518 7-2. Steps to take in an emergency

- 15** Attach the air release cap to the end of the hose.

If the air release cap is not attached, the sealant may leak and the vehicle may get dirty.

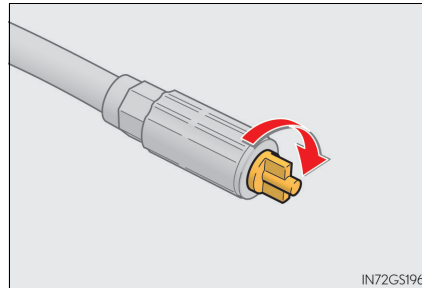

- 16** Temporarily store the bottle in the trunk while it is connected to the compressor.

- 17** To spread the liquid sealant evenly within the tire, immediately drive safely for about 5 km (3 miles) below 80 km/h (50 mph).

- 18** After driving for about 5 km (3 miles), stop your vehicle in a safe place on a hard, flat surface and remove the air release cap from the hose before reconnecting the repair kit.

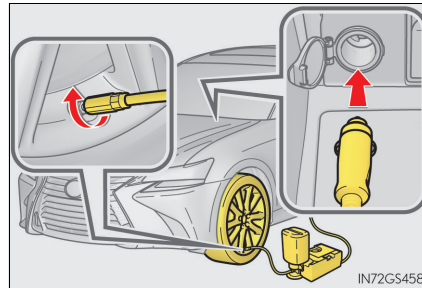

- 19** Turn the compressor switch on and wait for several seconds, and then turn it off. Check the tire inflation pressure.

- ① If the tire inflation pressure is under 130 kPa (1.3 kgf/cm² or bar, 19 psi): The puncture cannot be repaired. Contact any authorized Lexus retailer or Lexus authorized repairer, or any reliable repairer.

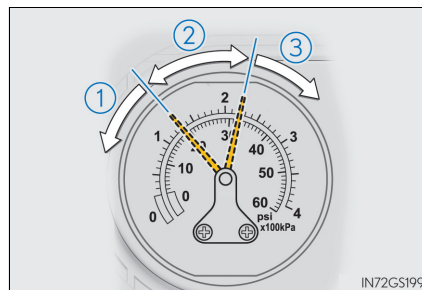

- ② If the tire inflation pressure is 130 kPa (1.3 kgf/cm² or bar, 19 psi) or higher, but less than the recommended level: Proceed to step **20**.

- ③ If the tire inflation pressure is the recommended level: Proceed to step **21**.

20 Turn the compressor switch on to inflate the tire until the recommended tire inflation pressure is reached. Drive for about 5 km (3 miles) and then perform step **18**.

21 Attach the air release cap to the end of the hose.

If the air release cap is not attached, the sealant may leak and the vehicle may get dirty.

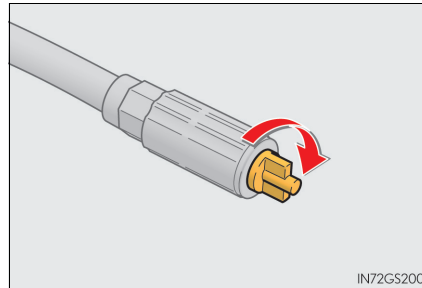

22 Store the bottle in the trunk while it is connected to the compressor.

23 Taking precautions to avoid sudden braking, sudden acceleration and sharp turns, drive carefully at under 80 km/h (50 mph) to any authorized Lexus retailer or Lexus authorized repairer, or any reliable repairer that is less than 100 km (62 miles) away for tire repair or replacement.

■ Emergency tire puncture repair kit

- The sealant has a limited lifespan. The expiry date is shown on the bottle. The sealant should be replaced before the expiry date. Contact any authorized Lexus retailer or Lexus authorized repairer, or any reliable repairer for replacement.
- The sealant stored in the emergency tire puncture repair kit can be used only once to temporarily repair a single tire. If the sealant has been used and need to be purchased, contact any authorized Lexus retailer or Lexus authorized repairer, or any reliable repairer.
- The sealant can be used when the outside temperature is from -40 °C (-40 °F) to 60 °C (140 °F).
- The repair kit is exclusively designed for size and type of tires originally installed on your vehicle. Do not use it for tires that a different size than the original ones, or for any other purposes.
- If the sealant gets on your clothes, it may stain.
- If the sealant adheres to a wheel or the surface of the vehicle body, the stain may not be removable if it is not cleaned at once. Immediately wipe away the sealant with a wet cloth.
- During operation of the repair kit, a loud operation noise is produced. This does not indicate a malfunction.
- Do not use the emergency tire puncture repair kit to check or to adjust the tire pressure.

■ If the tire is inflated to more than the recommended level

- 1 Disconnect the hose from the valve.
- 2 Install the air release cap to the end of the hose and push the protrusion on the air release cap into the tire valve to let some air out.

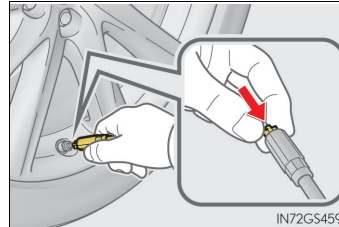

- 3 Disconnect the hose from the valve, remove the air release cap from the hose and then reconnect the hose.
- 4 Turn the compressor switch on and wait for several seconds, and then turn it off. Check that the air pressure indicator shows the recommended level. (→P. 555)
If the air pressure is lower than the recommended level, turn the compressor switch on again and repeat the inflation procedure until the recommended pressure is reached.

■ After a tire is repaired with the emergency tire puncture repair kit

- The tire pressure warning valve and transmitter should be replaced.
- Vehicles with the tire pressure warning system: Even if the tire inflation pressure is at the recommended level, the tire pressure warning light may come on/flash.

■ Note for checking the emergency tire puncture repair kit

Check the sealant expiry date occasionally.
The expiry date is shown on the bottle.
Do not use sealant whose expiry date has already passed. Otherwise, repairs conducted using the emergency tire puncture repair kit may not be performed properly.

⚠ WARNING

■ Caution while driving

Observe the following precautions.
Failure to do so may cause an accident.

- The emergency tire puncture repair kit is made exclusively for your vehicle. Do not use it on other vehicles.
- Do not use the emergency tire puncture repair kit for tires that are a different size than the specified ones or for any other purpose. Doing so may cause the tires to not be repaired properly.

■ Precautions for use of the sealant

- Ingesting the sealant is hazardous to your health. If you ingest sealant, consume as much water as possible, and then immediately consult a doctor.
- If sealant gets in eyes or adheres to skin, immediately wash it off with water. If discomfort persists, consult a doctor.

 **WARNING****■ When fixing the flat tire**

- Stop your vehicle in a safe and flat area.
- Do not touch the wheels or the area around the brakes immediately after the vehicle has been driven.
After the vehicle has been driven, the wheels and the area around the brakes may be extremely hot. Touching these areas with hands, feet or other body parts may result in burns.
- Connect the valve and hose securely with the tire installed on the vehicle.
- If the hose is not properly connected to the valve, air leakage may occur or sealant may be sprayed out.
- If the hose comes off the valve while inflating the tire, there is a risk that the hose will move abruptly due to air pressure.
- After inflation of the tire has completed, the sealant may splatter when the hose is disconnected or some air is let out of the tire.
- Follow the operation procedure to repair the tire. If the procedures not followed, the sealant may spray out.
- Keep back from the tire while it is being repaired, as there is a chance of it bursting while the repair operation is being performed. If you notice any cracks or deformation of the tire, turn off the compressor switch and stop the repair operation immediately.
- The repair kit may overheat if operated for a long period of time. Do not operate the repair kit continuously for more than 35 minutes.
- Parts of the repair kit become hot during operation. Be careful handling the repair kit during and after operation. Do not touch the metal part connecting the bottle and the compressor. It will be extremely hot.
- Do not attach the vehicle speed warning sticker to an area other than the one indicated. If the sticker is attached to an area where an SRS airbag is located, such as the pad of the steering wheel, it may prevent the SRS air bag from operating properly.

■ Driving to spread the liquid sealant evenly

- Drive the vehicle carefully at a low speed. Be especially careful when turning and cornering.
- If the vehicle does not drive straight or you feel a pull through the steering wheel, stop the vehicle and check the following:
 - Tire condition. The tire may have separated from the wheel.
 - Tire inflation pressure. If tire inflation pressure is 130 kPa (1.3 kgf/cm² or bar, 19 psi) or less, the tire may be severely damaged.



NOTICE

■ When performing an emergency repair

- Perform the emergency repair without removing the nail or screw that has punctured the tread of the tire. If the object that has punctured the tire is removed, repair by the emergency tire puncture repair kit may not be possible.
- The repair kit is not waterproof. Make sure that the repair kit is not exposed to water, such as when it is being used in the rain.
- Do not put the repair kit directly onto dusty ground such as sand at the side of the road. If the repair kit vacuums up dust etc., a malfunction may occur.

■ Handling the emergency tire puncture repair kit

- The repair kit power source should be 12 V DC suitable for vehicle use. Do not connect the repair kit to any other source.
- If gasoline splatters on the repair kit, the repair kit may deteriorate. Take care not to allow gasoline to contact it.
- Store the emergency tire puncture repair kit in the trunk.
The kit may be thrown around during sudden braking and so forth, damaging the kit.
- Store the repair kit in the trunk out of reach of children.
- Do not disassemble or modify the repair kit. Do not subject parts such as the air pressure indicator to impacts. This may cause a malfunction.

■ To avoid damage to the tire pressure warning valves and transmitters (vehicles with the tire pressure warning system)

When a tire is repaired with liquid sealants, the tire pressure warning valve and transmitter may not operate properly. If a liquid sealant is used, contact any authorized Lexus retailer or Lexus authorized repairer, or any reliable repairer or other qualified service shop as soon as possible. After use of liquid sealant, make sure to replace the tire pressure warning valve and transmitter when repairing or replacing the tire.
(→P. 418)

If the hybrid system will not start

Reasons for the hybrid system not starting vary depending on the situation. Check the following and perform the appropriate procedure:

The hybrid system will not start even though the correct starting procedure is being followed. (→P. 217)

One of the following may be the cause of the problem:

- The electronic key may not be functioning properly. (→P. 528)
- There may not be sufficient fuel in the vehicle's tank.
Refuel the vehicle.
- There may be a malfunction in the immobilizer system. (→P. 85)
- There may be a malfunction in the steering lock system.
- The hybrid system may be malfunctioning due to an electrical problem such as electronic key battery depletion or a blown fuse. However, depending on the type of malfunction, an interim measure is available to start the hybrid system. (→P. 524)

The interior lights and headlights are dim, or the horn does not sound or sounds at a low volume.

One of the following may be the cause of the problem:

- The 12-volt battery may be discharged. (→P. 530)
- The 12-volt battery terminal connections may be loose or corroded.
(→P. 412)

The interior lights and headlights do not turn on, or the horn does not sound.

One of the following may be the cause of the problem:

- The 12-volt battery may be discharged. (→P. 530)
- One or both of the 12-volt battery terminals may be disconnected. (→P. 412)

Contact any authorized Lexus retailer or Lexus authorized repairer, or any reliable repairer if the problem cannot be repaired, or if repair procedures are unknown.

Emergency start function

When the hybrid system does not start, the following steps can be used as an interim measure to start the hybrid system if the power switch is functioning normally.

Do not use this starting procedure except in cases of emergency.

- 1** Press the parking brake switch to check that the parking brake is set.
(→P. 232)
Parking brake indicator will come on.
- 2** Shift the shift lever to P.
- 3** Turn the power switch to ACCESSORY mode.
- 4** Press and hold the power switch for about 15 seconds while depressing the brake pedal firmly.

Even if the hybrid system can be started using the above steps, the system may be malfunctioning. Have the vehicle inspected by any authorized Lexus retailer or Lexus authorized repairer, or any reliable repairer.

If the parking brake cannot be released

In the event that the 12-volt battery is discharged or switch operation does not release the parking brake, the parking brake can be released manually using the procedure below. This procedure should be performed only if necessary, such as in an emergency.

If the switch cannot be operated even when the 12-volt battery is normal, the parking brake system may be malfunctioning. Have the vehicle inspected by any authorized Lexus retailer or Lexus authorized repairer, or any reliable repairer immediately.

Before releasing the parking brake manually

- Shift the shift lever to P.
- Turn the power switch off.
- Check that the parking brake indicator is off.
- Chock the tires.

Releasing the parking brake manually

- 1 Take out the parking brake release tool and the screwdriver from the trunk. (→P. 499, 511)

Fit the parking brake release tool into the screwdriver handle.

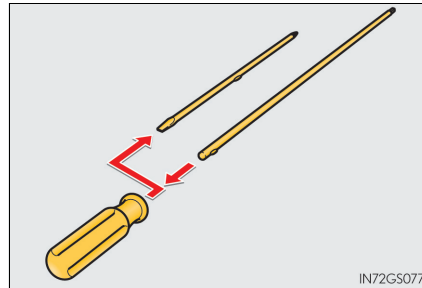

- 2 Vehicles with spare tire: Take out the spare tire. (→P. 501)
Vehicles without spare tire: Remove the center auxiliary box. (→P. 513)

- 3 Remove the plug.

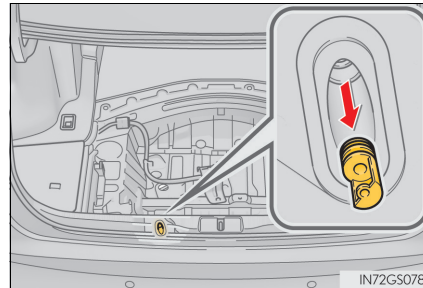

- 4 Insert the tool and press it down firmly while turning it counterclockwise until it stops.

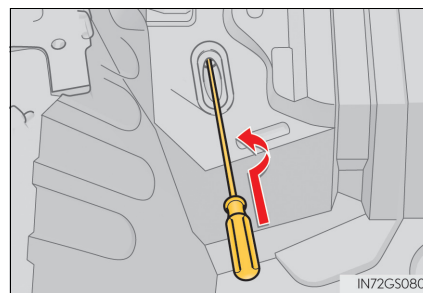

■ **Manual operation of the parking brake**

The parking brake cannot be set manually.

⚠ WARNING

■ **When releasing the parking brake manually**

- Shift the shift lever to P, turn the power switch off and chock the tires. Failure to do so may cause the vehicle to move, resulting in an accident.
- Turn the power switch off and check that the parking brake indicator is off. Failure to do so may cause the system to operate and turn the inserted parking brake release tool, resulting in an injury.

If the electronic key does not operate properly

If communication between the electronic key and vehicle is interrupted (→P. 155) or the electronic key cannot be used because the battery is depleted, the smart entry & start system and wireless remote control cannot be used. In such cases, the doors and trunk can be opened and the hybrid system can be started by following the procedure below.

Locking and unlocking the doors, unlocking the trunk and key linked functions

■ Doors

Use the mechanical key (→P. 135) in order to perform the following operations:

- ① Locks all the doors
- ② Closes the windows and moon roof (turn and hold)*
- ③ Unlocks all the doors
- ④ Opens the windows and moon roof (turn and hold)*

*: This setting must be customized at any authorized Lexus retailer or Lexus authorized repairer, or any reliable repairer.

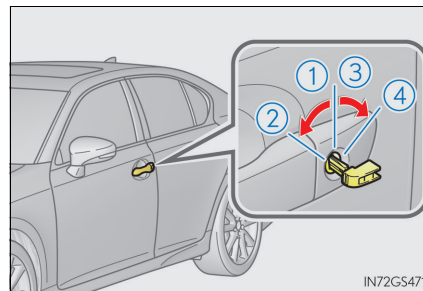

IN72GS471

■ Trunk

Turn the mechanical key clockwise to open.

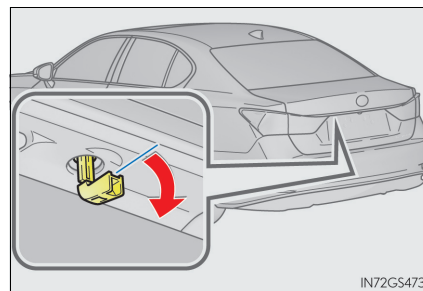

IN72GS473

Starting the hybrid system

1 Ensure that the shift lever is in P and depress the brake pedal.

2 Touch the Lexus emblem side of the electronic key to the power switch.

When the electronic key is detected, a buzzer sounds and the power switch will turn to ON mode.

When the smart entry & start system is deactivated in customization setting, the power switch will turn to ACCESSORY mode.

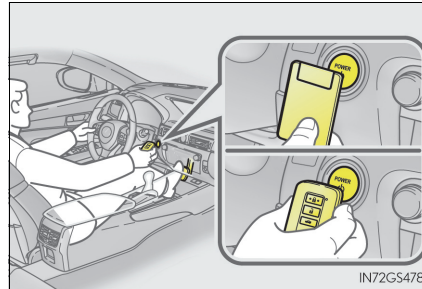

3 Firmly depress the brake pedal and check that  is shown on the multi-information display.

4 Press the power switch.

In the event that the hybrid system still cannot be started, contact any authorized Lexus retailer or Lexus authorized repairer, or any reliable repairer.

■ Stopping the hybrid system

Shift the shift lever to P and press the power switch as you normally do when stopping the hybrid system.

■ Replacing the key battery

As the above procedure is a temporary measure, it is recommended that the electronic key battery be replaced immediately when the battery is depleted. (→P. 435)

■ Alarm (if equipped)

Using the mechanical key to lock the doors or trunk will not set the alarm system. If a door or trunk are unlocked using the mechanical key when the alarm system is set, the alarm may be triggered. (→P. 91)

■ Changing power switch modes

Release the brake pedal and press the power switch in step 3 above. The hybrid system does not start and modes will be changed each time the switch is pressed. (→P. 218)

■ When the electronic key does not work properly

- Make sure that the smart entry & start system has not been deactivated in the customization setting. If it is off, turn the function on. (Customizable features: →P. 561)
- Check if battery-saving mode is set. If it is set, cancel the function. (→P. 154)

 **WARNING****■ When using the mechanical key and operating the power windows or moon roof (if equipped)**

Operate the power window or moon roof after checking to make sure that there is no possibility of any passenger having any of their body parts caught in the window or moon roof.

Also, do not allow children to operate the mechanical key. It is possible for children and other passengers to get caught in the power window or moon roof.

If the 12-volt battery is discharged

The following procedures may be used to start the hybrid system if the 12-volt battery is discharged.

You can also call any authorized Lexus retailer or Lexus authorized repairer, or any reliable repairer.

If you have a set of jumper (or booster) cables and a second vehicle with a 12-volt battery, you can jump start your vehicle by following the steps below.

- 1 Confirm that the electronic key is being carried.

When connecting the jumper (or booster) cables, depending on the situation, the alarm may activate and doors locked. (→P. 93)

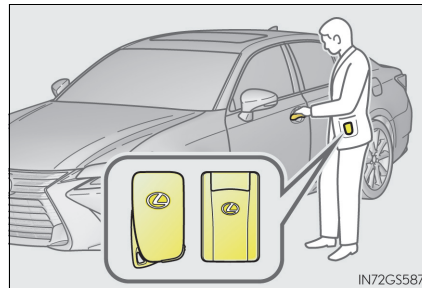

- 2 Open the hood (→P. 401), remove the engine compartment covers (→P. 405) and open the fuse box cover.

- 1 Remove all of the clips.
- 2 Push the tabs on either side to detach the lock and lift the lid off while pulling the lock plate.

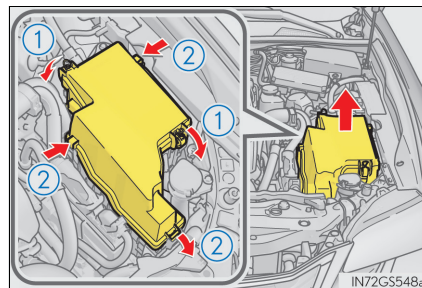

- 3 Open the exclusive jump starting terminal cover.

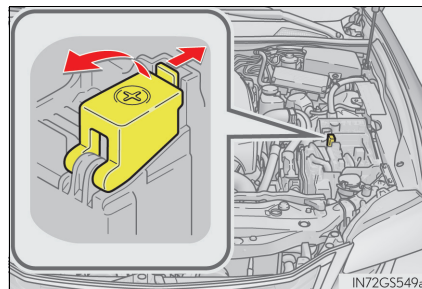

- 4 GS450h: Remove the engine cover.

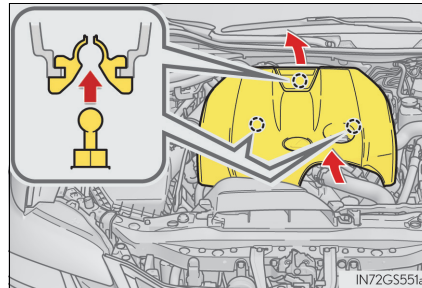

- 5 Connect the jumper cables according to the following procedure:

- ▶ GS450h

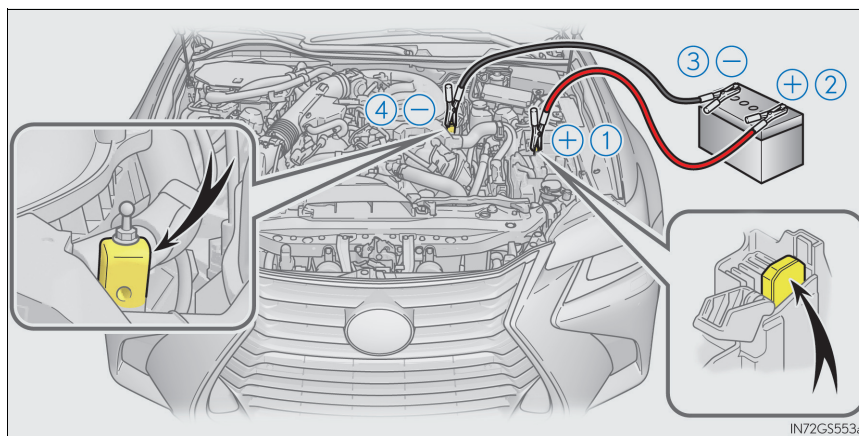

- ▶ GS300h

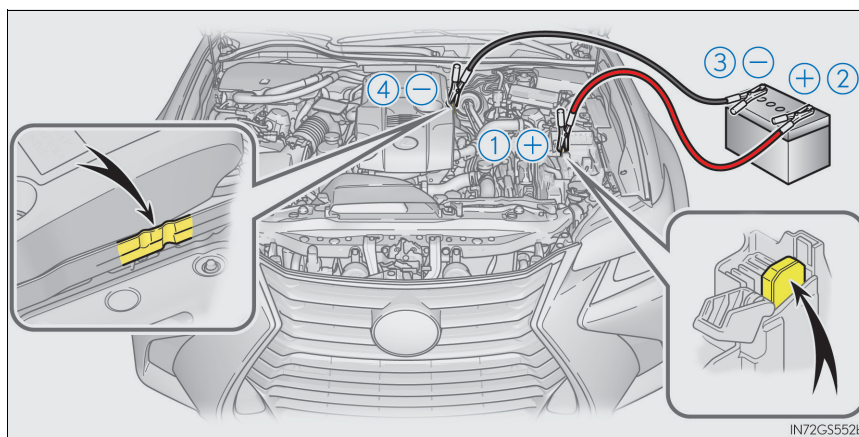

- ① Connect a positive jumper cable clamp to the exclusive jump starting terminal on your vehicle.
- ② Connect the clamp on the other end of the positive cable to the positive (+) battery terminal on the second vehicle.
- ③ Connect a negative cable clamp to the negative (-) battery terminal on the second vehicle.
- ④ Connect the clamp at the other end of the negative cable to a solid, stationary, unpainted metallic point away from the exclusive jump starting terminal and any moving parts, as shown in the illustration.
- ⑥ Start the engine of the second vehicle. Increase the engine speed slightly and maintain at that level for approximately 5 minutes to recharge the 12-volt battery of your vehicle.
- ⑦ Open and close any of the doors of your vehicle with the power switch off.
- ⑧ Maintain the engine speed of the second vehicle and start the hybrid system of your vehicle by turning the power switch to ON mode.
- ⑨ Make sure the "READY" indicator comes on. If the indicator does not come on, contact any authorized Lexus retailer or Lexus authorized repairer, or any reliable repairer.
- ⑩ Once the hybrid system has started, remove the jumper cables in the exact reverse order from which they were connected.

Once the hybrid system starts, have the vehicle inspected at any authorized Lexus retailer or Lexus authorized repairer, or any reliable repairer as soon as possible.

■ Starting the hybrid system when the 12-volt battery is discharged

The hybrid system cannot be started by push-starting.

■ To prevent 12-volt battery discharge

- Turn off the headlights and the audio system while the hybrid system is off.
- Turn off any unnecessary electrical components when the vehicle is running at a low speed for an extended period, such as in heavy traffic.

■ Charging the 12-volt battery

The electricity stored in the 12-volt battery will discharge gradually even when the vehicle is not in use, due to natural discharge and the draining effects of certain electrical appliances. If the vehicle is left for a long time, the 12-volt battery may discharge, and the hybrid system may be unable to start. (The 12-volt battery recharges automatically while the hybrid system is operating.)

■ When recharging or replacing the 12-volt battery

- In some cases, it may not be possible to unlock the doors using the smart entry & start system when the 12-volt battery is discharged. Use the wireless remote control or the mechanical key to lock or unlock the doors.
- The hybrid system may not start on the first attempt after the 12-volt battery has recharged but will start normally after the second attempt. This is not a malfunction.
- The power switch mode is memorized by the vehicle. When the 12-volt battery is reconnected, the system will return to the mode it was in before the 12-volt battery was discharged. Before disconnecting the 12-volt battery, turn the power switch off. If you are unsure what mode the power switch was in before the 12-volt battery discharged, be especially careful when reconnecting the 12-volt battery.

WARNING

■ Avoiding 12-volt battery fires or explosions

Observe the following precautions to prevent accidentally igniting the flammable gas that may be emitted from the 12-volt battery:

- Make sure each jumper cable is connected to the correct terminal and that it is not unintentionally in contact with any other than the intended terminal.
- Do not allow the other end of the jumper cable connected to the “+” terminal to come into contact with any other parts or metal surfaces in the area, such as brackets or unpainted metal.
- Do not allow the + and - clamps of the jumper cables to come into contact with each other.
- Do not smoke, use matches, cigarette lighters or allow open flame near the 12-volt battery.

 **WARNING****■ 12-volt battery precautions**

The 12-volt battery contains poisonous and corrosive acidic electrolyte, while related parts contain lead and lead compounds. Observe the following precautions when handling the 12-volt battery:

- When working with the 12-volt battery, always wear safety glasses and take care not to allow any 12-volt battery fluids (acid) to come into contact with skin, clothing or the vehicle body.
- Do not lean over the 12-volt battery.
- In the event that 12-volt battery fluid comes into contact with the skin or eyes, immediately wash the affected area with water and seek medical attention.
Place a wet sponge or cloth over the affected area until medical attention can be received.
- Always wash your hands after handling the 12-volt battery support, terminals, and other battery-related parts.
- Do not allow children near the 12-volt battery.

■ After recharging the 12-volt battery

Have the 12-volt battery inspected at any authorized Lexus retailer or Lexus authorized repairer, or any reliable repairer as soon as possible.

If the 12-volt battery is deteriorating, continued use may cause the 12-volt battery to emit a malodorous gas, which may be detrimental to the health of passengers.

■ When replacing the 12-volt battery

→P. 414

 **NOTICE****■ When handling jumper cables**

When connecting the jumper cables, ensure that they do not become entangled in the cooling fans or belt.

■ To prevent damaging the vehicle

The exclusive jump starting terminal is to be used when charging the 12-volt battery from another vehicle in an emergency. It cannot be used to jump start another vehicle.

If your vehicle overheats

The following may indicate that your vehicle is overheating.

- The needle of the engine coolant temperature gauge (→P. 104) enters the red zone or a loss of hybrid system power is experienced. (For example, the vehicle speed does not increase.)
- “Engine Coolant Temp High Stop in a Safe Place See Owner’s Manual” or “Hybrid System Overheated Reduced Output Power” (→P. 466) is shown on the multi-information display.
- Steam comes out from under the hood.

Correction procedures

- If the needle of the engine coolant temperature gauge enters the red zone or “Engine Coolant Temp High Stop in a Safe Place See Owner’s Manual” is shown on the multi-information display

- 1 Stop the vehicle in a safe place and turn off the air conditioning system, and then stop the hybrid system.
- 2 If you see steam:
Carefully lift the hood after the steam subsides.
If you do not see steam:
Carefully lift the hood.
- 3 After the hybrid system has cooled down sufficiently, inspect the hoses and cooling system for leaks.

- ① Radiator
- ② Cooling fans

If a large amount of coolant leaks, immediately contact any authorized Lexus retailer or Lexus authorized repairer, or any reliable repairer.

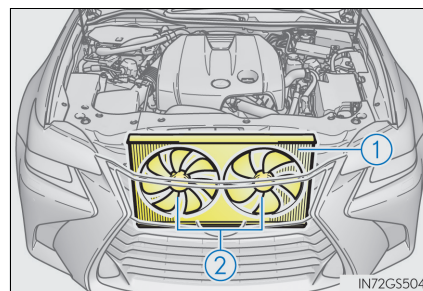

536 7-2. Steps to take in an emergency

4 The coolant level is satisfactory if it is between the “FULL” and “LOW” lines on the reservoir.

- ① Reservoir
- ② “FULL”
- ③ “LOW”
- ④ Coolant inlet cap

▶ GS450h

▶ GS300h

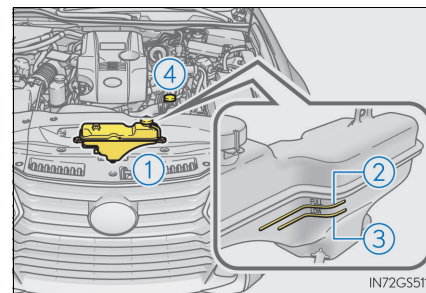
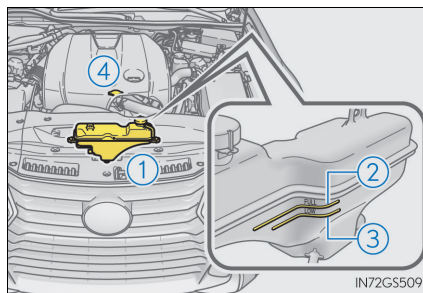

5 Add coolant if necessary. (→P. 539)

Water can be used in an emergency if engine coolant is unavailable.

▶ GS450h

▶ GS300h

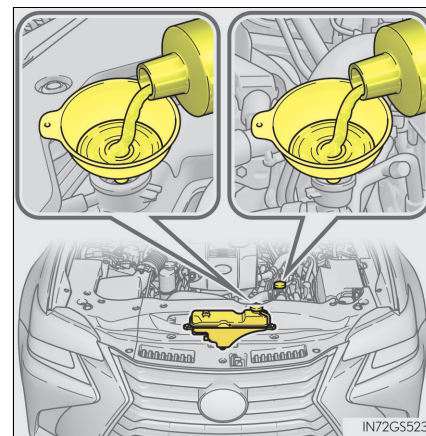
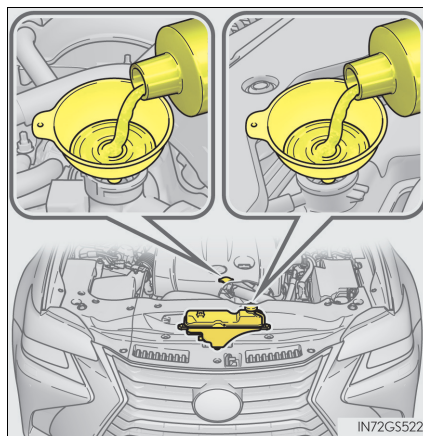

- 6 Start the hybrid system and turn the air conditioning system on to check that the radiator cooling fans operate and to check for coolant leaks from the radiator or hoses.

The fans operate when the air conditioning system is turned on immediately after a cold start. Confirm that the fans are operating by checking the fan sound and air flow. If it is difficult to check these, turn the air conditioning system on and off repeatedly. (The fans may not operate in freezing temperatures.)

- 7 If the fans are not operating:
Stop the hybrid system immediately and contact any authorized Lexus retailer or Lexus authorized repairer, or any reliable repairer.

If the fans are operating:

Have the vehicle inspected at the nearest any authorized Lexus retailer or Lexus authorized repairer, or any reliable repairer.

■ If “Hybrid System Overheated Reduced Output Power” is shown on the multi-information display

- 1 Stop the vehicle in a safe place.
2 Stop the hybrid system and carefully lift the hood.
3 After the hybrid system has cooled down, inspect the hoses and radiator core (radiator) for any leaks.

① Radiator

② Cooling fans

If a large amount of coolant leaks, immediately contact any authorized Lexus retailer or Lexus authorized repairer, or any reliable repairer.

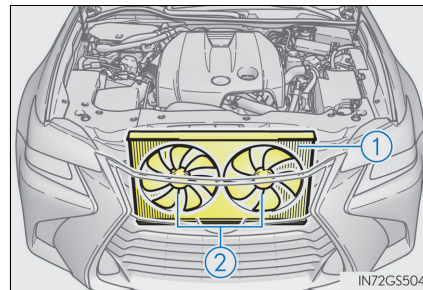

538 7-2. Steps to take in an emergency

- 4** The coolant level is satisfactory if it is between the “FULL”/“F” and “LOW”/“L” lines on the reservoir.

- ① Reservoir
- ② “FULL”/“F”
- ③ “LOW”/“L”

▶ GS450h

▶ GS300h

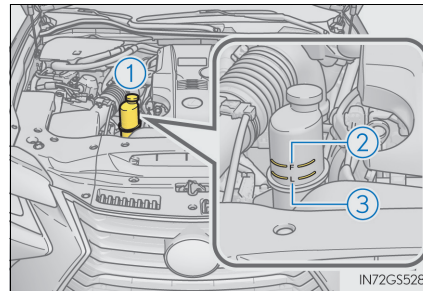
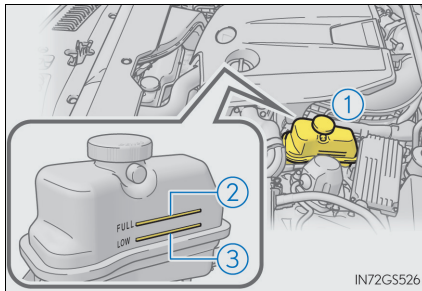

- 5** Add coolant if necessary.

Water can be used in an emergency if power control unit coolant is unavailable.

▶ GS450h

▶ GS300h

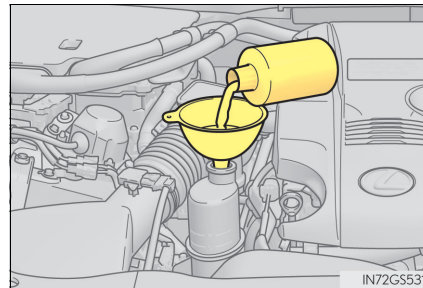
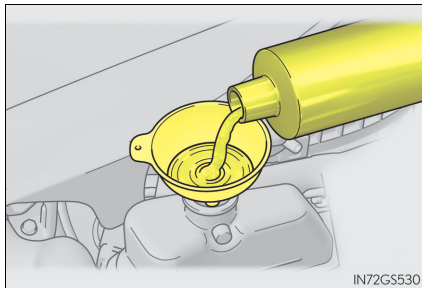

- 6** Start the hybrid system and check for the multi-information display.

If the message does not disappear:

Stop the hybrid system and contact any authorized Lexus retailer or Lexus authorized repairer, or any reliable repairer.

If the message is not displayed:

Have the vehicle inspected at the nearest any authorized Lexus retailer or Lexus authorized repairer, or any reliable repairer.

■ When adding coolant

Add coolant in accordance with the following procedure.

- 1 Remove caps A and B.
- 2 Add coolant through the inlet of cap A up to the "[GR-HV] B" line/"[AR/GR] B" line, and then install cap A.
- 3 Add coolant through the inlet of cap B until it is full, and then install cap B.

GS300h only: When installing cap B, apply coolant to the O-ring on the end of cap B.

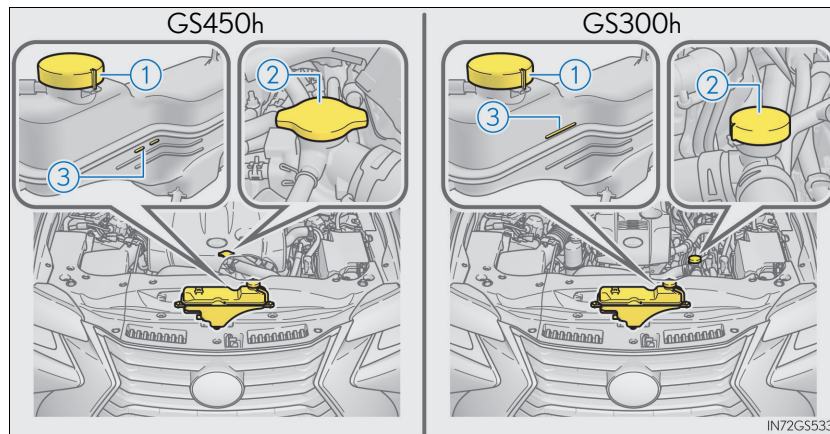

- 1 Cap A
- 2 Cap B
- 3 GS450h: "[GR-HV] B" line (Target fill line)
GS300h: "[AR/GR] B" line (Target fill line)

⚠ WARNING

■ **When inspecting under the hood of your vehicle**

Observe the following precautions.
Failure to do so may result in serious injury such as burns.

- If steam is seen coming from under the hood, do not open the hood until the steam has subsided. The engine compartment may be very hot.
- After the hybrid system has been turned off, check that the indicator on the power switch and the "READY" indicator are off.
When the hybrid system is operating, the gasoline engine may automatically start, or the cooling fan may suddenly operate even if the gasoline engine stops. Do not touch or approach rotating parts such as the fan, which may lead to fingers or clothing (especially a tie, a scarf or a muffler) getting caught, resulting in serious injury.
- Do not loosen the coolant inlet cap or the coolant reservoir caps while the hybrid system and radiator are hot. High temperature steam or coolant could spray out.

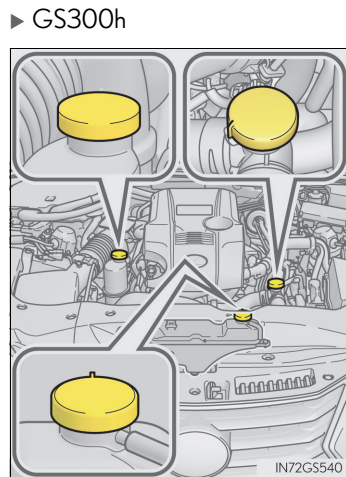
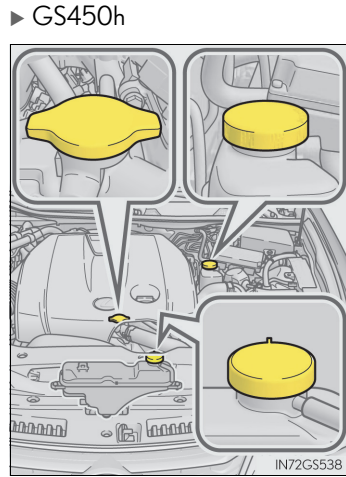

**NOTICE****■ When adding engine/power control unit coolant**

Add coolant slowly after the hybrid system has cooled down sufficiently. Adding cool coolant to a hot hybrid system too quickly can cause damage to the hybrid system.

■ To prevent damage to the cooling system

Observe the following precautions:

- Avoid contaminating the coolant with foreign matter (such as sand or dust etc.).
- Do not use any coolant additive.

If the vehicle becomes stuck

Carry out the following procedures if the tires spin or the vehicle becomes stuck in mud, dirt or snow:

- 1 Stop the hybrid system. Set the parking brake and shift the shift lever to P.
- 2 Remove the mud, snow or sand from around the rear wheels.
- 3 Place wood, stones or some other material under the rear wheels to help provide traction.
- 4 Restart the hybrid system.
- 5 Shift the shift lever to D or R and release the parking brake. Then, while exercising caution, depress the accelerator pedal.

■ When it is difficult to free the vehicle

Press  to turn off TRC. (→P. 326)

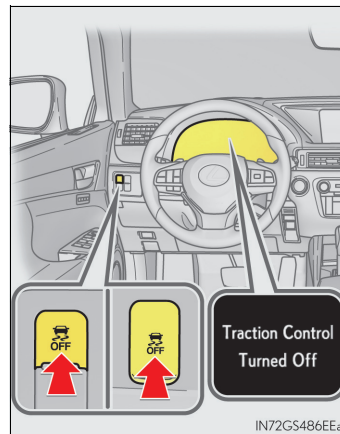

WARNING

■ When attempting to free a stuck vehicle

If you choose to push the vehicle back and forth to free it, make sure the surrounding area is clear to avoid striking other vehicles, objects or people. The vehicle may also lunge forward or lunge back suddenly as it becomes free. Use extreme caution.

■ When shifting the shift lever

Be careful not to shift the shift lever with the accelerator pedal depressed. This may lead to unexpected rapid acceleration of the vehicle that may cause an accident resulting in death or serious injury.



NOTICE

■ To avoid damaging the transmission and other components

- Avoid spinning the rear wheels and depressing the accelerator pedal more than necessary.
- If the vehicle remains stuck even after these procedures are performed, the vehicle may require towing to be freed.

Vehicle specifications

8

8-1. Specifications

Maintenance data
(fuel, oil level, etc.) 546

Fuel information.....559

8-2. Customization

Customizable features 561

8-3. Initialization

Item to initialize..... 576

Maintenance data (fuel, oil level, etc.)

Dimensions and weights

Overall length		4850 mm (190.9 in.)
Overall width		1840 mm (72.4 in.)
Overall height ^{*1}		1455 mm (57.3 in.)
Wheelbase		2850 mm (112.2 in.)
Tread ^{*1}	Front	1575 mm (62.0 in.)
	Rear	1590 mm (62.6 in.) 1560 mm (61.4 in.)*2
Gross vehicle mass		2235 kg (4927 lb.)*3 2265 kg (4993 lb.)*4 2305 kg (5082 lb.)*5 2335 kg (5148 lb.)*6
Maximum permissible axle capacity	Front	1120 kg (2469 lb.)
	Rear	1270 kg (2800 lb.)
Drawbar load ^{*7}		80 kg (176 lb.)
Towing capacity ^{*7}	With brake	500 kg (1102 lb.)*8 1500 kg (3307 lb.)*9
	Without brake	0 kg (0 lb.)*8 750 kg (1653 lb.)*9

*1: Unladen vehicle

*2: Vehicles with 265/35R19 tires

*3: AWL10L-BEXEHW and AWL10R-BEXEHW models^{*10}

*4: AWL10L-BEXQHW and AWL10R-BEXQHW models^{*10}

*5: GWL10L-BEXEBW and GWL10R-BEXEBW models^{*10}

*6: GWL10L-BEXQBW and GWL10R-BEXQBW models^{*10}

*7: Vehicles with towing package

*8: GS300h

*9: GS450h

*10: The model code is indicated on the manufacturer's label. (→P. 547)

Vehicle identification

■ Vehicle identification number

The vehicle identification number (VIN) is the legal identifier for your vehicle. This is the primary identification number for your Lexus. It is used in registering the ownership of your vehicle.

This number is stamped on the top left of the instrument panel and in the engine compartment.

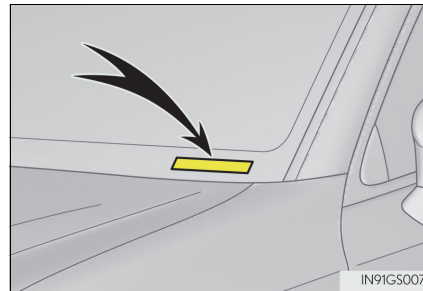

▶ GS450h

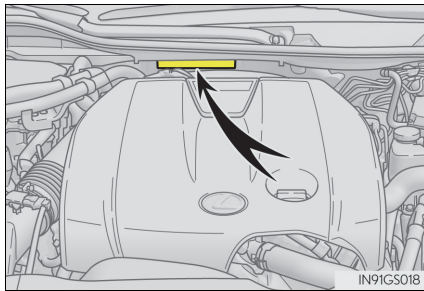

▶ GS300h

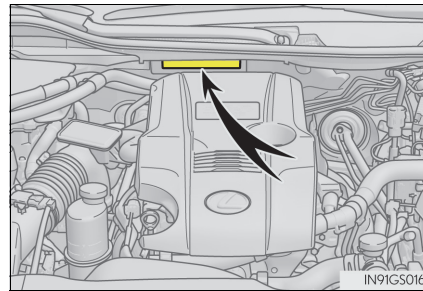

This number is also on the manufacturer's label.

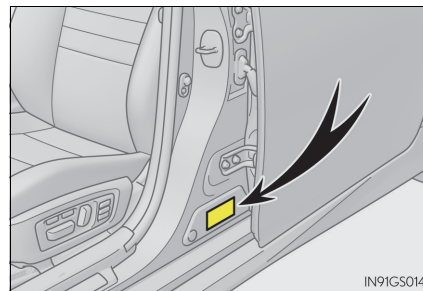

■ Engine number

The engine number is stamped on the engine block as shown.

▶ GS450h

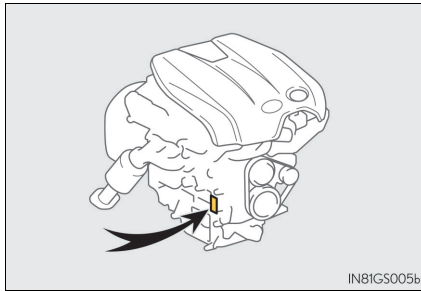

▶ GS300h

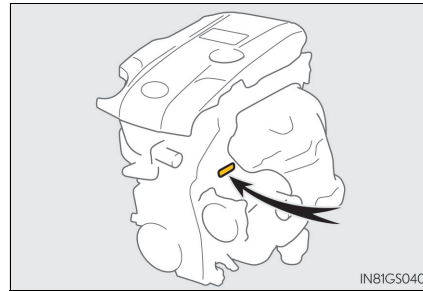

Engine

▶ GS450h

Model	2GR-FXE
Type	6-cylinder V type, 4-cycle, gasoline
Bore and stroke	94.0 × 83.0 mm (3.70 × 3.27 in.)
Displacement	3456 cm ³ (210.9 cu.in.)
Valve clearance	Automatic adjustment
Drive belt tension	

▶ GS300h

Model	2AR-FSE
Type	4-cylinder in line, 4-cycle, gasoline
Bore and stroke	90.0 × 98.0 mm (3.54 × 3.86 in.)
Displacement	2494 cm ³ (152.2 cu.in.)
Valve clearance	Automatic adjustment
Drive belt tension	

Fuel

Fuel type	EU area: Unleaded gasoline conforming to European standard EN228 only Except EU area: Unleaded gasoline only
Research Octane Number	95 or higher
Fuel tank capacity (Reference)	66 L (17.4 gal., 14.5 Imp.gal.)

Electric motor (traction motor)

Type	Permanent magnet synchronous motor	
Maximum output	GS450h	147 kW
	GS300h	105 kW
Maximum torque	GS450h	275 N•m (28.0 kgf•m, 202.8 ft•lbf)
	GS300h	300 N•m (30.6 kgf•m, 221.3 ft•lbf)

Hybrid battery (traction battery)

Type	Nickel-Metal hydride battery	
Voltage	7.2 V/module	
Capacity	6.5 Ah (3HR)	
Quantity	GS450h	40 modules
	GS300h	32 modules
Overall voltage	GS450h	288 V
	GS300h	230.4 V

Lubrication system

Oil capacity (Drain and refill— reference*)	GS450h	GS300h
With filter	6.3 L (6.7 qt., 5.5 Imp.qt.)	4.5 L (4.8 qt., 4.0 Imp. qt.)
Without filter	5.9 L (6.2 qt., 5.2 Imp.qt.)	4.1L (4.3 qt., 3.6 Imp. qt.)

*: The engine oil capacity is a reference quantity to be used when changing the engine oil. Warm up the engine and turn off the hybrid system, wait more than 5 minutes, and check the oil level on the dipstick.

■ **Engine oil selection**

“Toyota Genuine Motor Oil” is used in your Lexus vehicle. Lexus recommends the use of approved “Toyota Genuine Motor Oil”. Another motor oil of matching quality can also be used.

Oil grade:

0W-20, 5W-30 and 10W-30:

API grade SL “Energy-Conserving”, SM “Energy-Conserving” or SN “Resource-Conserving”; or ILSAC multigrade engine oil

15W-40:

API grade SL, SM or SN multigrade engine oil

Recommended viscosity (SAE):

SAE 0W-20 is filled into your Lexus vehicle at manufacturing, and the best choice for good fuel economy and good starting in cold weather.

If SAE 0W-20 oil is not available, SAE 5W-30 oil may be used. However, it should be replaced with SAE 0W-20 at the next oil change.

If you use SAE 10W-30 or a higher viscosity engine oil in extremely low temperatures, the engine may become difficult to start, so SAE 0W-20 or 5W-30 engine oil is recommended.

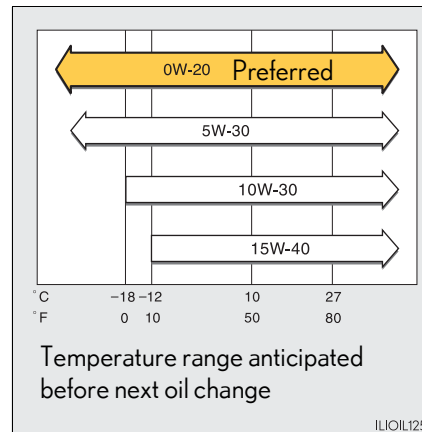

Oil viscosity (0W-20 is explained here as an example):

- The 0W in 0W-20 indicates the characteristic of the oil which allows cold startability. Oils with a lower value before the W allow for easier starting of the engine in cold weather.
- The 20 in 0W-20 indicates the viscosity characteristic of the oil when the oil is at high temperature. An oil with a higher viscosity (one with a higher value) may be better suited if the vehicle is operated at high speeds, or under extreme load conditions.

How to read oil container labels:

Either or both API registered marks are added to some oil containers to help you select the oil you should use.

① API Service Symbol

Top portion: "API SERVICE SN" means the oil quality designation by American Petroleum Institute (API).

Center portion: "SAE 0W-20" means the SAE viscosity grade.

Lower portion: "Resource-Conserving" means that the oil has fuel-saving and environmental protection capabilities.

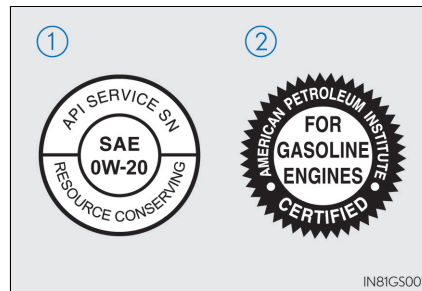

② ILSAC Certification Mark

The International Lubricant Specification Advisory Committee (ILSAC) Certification Mark is displayed on the front of the container.

Cooling system

		Gasoline engine	Power control unit	
			Left-hand drive vehicles	Right-hand drive vehicles
Capacity	GS450h	9.2 L (9.7qt., 8.1 Imp.qt.)	2.1 L (2.2qt., 1.8 Imp.qt.)	1.9 L (2.0qt., 1.7 Imp.qt.)
	GS300h	8.1 L (8.6 qt., 7.1 Imp.qt.)	1.6 L (1.7 qt., 1.4 Imp.qt.)	1.8 L (1.9 qt., 1.6 Imp.qt.)
Coolant type		Use either of the following: <ul style="list-style-type: none"> • "Toyota Super Long Life Coolant" • Similar high-quality ethylene glycol-based non-silicate, non-amine, non-nitrite, and non-borate coolant with long-life hybrid organic acid technology Do not use plain water alone.		

Ignition system

Spark plug	DENSO FK20HBR8 0.8 mm (0.031 in.)
Make	
Gap	

 NOTICE

■ Iridium-tipped spark plugs

Use only iridium-tipped spark plugs. Do not adjust the spark plug gap.

Electrical system

12-volt battery	
Open voltage at 20°C (68°F):	12.0 V or higher (Voltage is checked 20 minutes after the hybrid system and all lights are turned off.)
Charging rates	5 A max.

Hybrid transmission

Fluid capacity*	GS450h	5.69 L (6.01 qt., 5.01 Imp.qt.)
	GS300h	3.80 L (4.02 qt., 3.34 Imp.qt.)
Fluid type	Toyota Genuine ATF WS	

*: The fluid capacity is the quantity of reference.

If replacement is necessary, contact any authorized Lexus retailer or Lexus authorized repairer, or any reliable repairer.

NOTICE

■ Hybrid transmission fluid type

Using transmission fluid other than "Toyota Genuine ATF WS" may cause deterioration in shift quality and ultimately damage the transmission of your vehicle.

Differential

Oil capacity	1.35 L (1.43 qt., 1.19 Imp.qt.)
Oil type and viscosity	Toyota Genuine Differential gear oil LT 75W-85 GL-5 or equivalent

Your Lexus vehicle is filled with "Toyota Genuine Differential Gear Oil" at the factory. Use Lexus approved "Toyota Genuine Differential Gear Oil" or an equivalent of matching quality to satisfy the above specification. Please contact any authorized Lexus retailer or Lexus authorized repairer, or any reliable repairer for further details.

Brakes

Pedal clearance *	115 mm (4.5 in.) Min.
Pedal free play	1.0 – 6.0 mm (0.04 – 0.24 in.)
Fluid type	SAE J1703 or FMVSS No. 116 DOT 3, SAE J1704 or FMVSS No. 116 DOT 4

*: Minimum pedal clearance when depressed with a force of 500 N (51.0 kgf, 112.4 lbf) while the hybrid system is operating.

When performing the brake pedal inspection, also be sure to check that the brake system warning light is not illuminated when the hybrid system is operating (If the brake system warning light is illuminated, refer to P. 460).

Steering

Free play	Less than 30 mm (1.2 in.)
-----------	---------------------------

Tires and wheels

► Type A

Tire size	225/50R17 94W		
Tire inflation pressure (Recommended cold tire inflation pressure)	Vehicle speed	Front tire kPa (kgf/cm ² or bar, psi)	Rear tire kPa (kgf/cm ² or bar, psi)
	More than 190 km/h (118 mph)	300 (3.0, 44)	300 (3.0, 44)
	Normal pressure: 190 km/h (118 mph) or less	240 (2.4, 35)	240 (2.4, 35)
	ECO pressure[*]: 190 km/h (118 mph) or less	270 (2.7, 39)	270 (2.7, 39)
Wheel size	17 × 7 1/2J		
Wheel nut torque	103 N•m (10.5 kgf•m, 76 ft•lbf)		

*: For optimizing fuel economy, ECO tire pressure is recommended. Tire pressure affects traveling comfort, road noise and steering characteristics.

► Type B

Tire size	235/45R18 94Y		
Tire inflation pressure (Recommended cold tire inflation pressure)	Vehicle speed	Front tire kPa (kgf/cm ² or bar, psi)	Rear tire kPa (kgf/cm ² or bar, psi)
	More than 220 km/h (137 mph)	300 (3.0, 44)	300 (3.0, 44)
	220 km/h (137 mph) or less	240 (2.4, 35)	240 (2.4, 35)
Wheel size	18 × 8J		
Wheel nut torque	103 N•m (10.5 kgf•m, 76 ft•lbf)		

► Type C

Tire size	235/40R19 96Y XL		
Tire inflation pressure (Recommended cold tire inflation pressure)	Vehicle speed	Front tire kPa (kgf/cm ² or bar, psi)	Rear tire kPa (kgf/cm ² or bar, psi)
	More than 220 km/h (137 mph)	300 (3.0, 44)	300 (3.0, 44)
	220 km/h (137 mph) or less	240 (2.4, 35)	250 (2.5, 36)
Wheel size	19 × 8J		
Wheel nut torque	103 N•m (10.5 kgf•m, 76 ft•lbf)		

▶ Type D

Tire size	235/40R19 96Y XL (front) and 265/35R19 94Y (rear)		
Tire inflation pressure (Recommended cold tire inflation pressure)	Vehicle speed	Front tire kPa (kgf/cm ² or bar, psi)	Rear tire kPa (kgf/cm ² or bar, psi)
	More than 220 km/h (137 mph)	300 (3.0, 44)	300 (3.0, 44)
	220 km/h (137 mph) or less	240 (2.4, 35)	250 (2.5, 36)
Wheel size	19 × 8J (235/40R19), 19 × 9J (265/35R19)		
Wheel nut torque	103 N•m (10.5 kgf•m, 76 ft•lbf)		

▶ Compact spare tire (if equipped)

Tire size	T155/70D17 110M, T145/70D18 107M
Tire inflation pressure (Recommended cold tire inflation pressure)	420 kPa (4.2 kgf/cm ² or bar, 60 psi)
Wheel size	17 × 4T (T155/70D17), 18 × 4T (T145/70D18)
Wheel nut torque	103 N•m (10.5 kgf•m, 76 ft•lbf)

■ When towing a trailer

Add 20.0 kPa (0.2 kgf/cm² or bar, 3 psi) to the recommended tire inflation pressure and drive at speeds below 100 km/h (62 mph).

Light bulbs

	Light bulbs	W	Type
Exterior	Front turn signal lights*	21	A
	Outer foot lights	5	B
Interior	Vanity lights	8	B
	Trunk light	3.8	B

A: Wedge base bulbs (amber)

B: Wedge base bulbs (clear)

*: Vehicles with single-beam headlights

Fuel information

EU area:

You must only use unleaded gasoline conforming to European standard EN228.

Select unleaded gasoline with a Research Octane Number of 95 or higher for optimum engine performance.

Except EU area:

You must only use unleaded gasoline.

Select unleaded gasoline with a Research Octane Number of 95 or higher.

■ Use of ethanol blended gasoline in a gasoline engine

Lexus allows the use of ethanol blended gasoline where the ethanol content is up to 10%. Make sure that the ethanol blended gasoline to be used has a Research Octane Number that follows the above.

■ If your engine knocks

- Consult any authorized Lexus retailer or Lexus authorized repairer, or any reliable repairer.
- You may occasionally notice light knocking for a short time while accelerating or driving uphill. This is normal and there is no need for concern.

 NOTICE■ **Notice on fuel quality**

- Do not use improper fuels. If improper fuels are used, the engine will be damaged.
- Do not use leaded gasoline.
Leaded gasoline will cause the three-way catalytic converter to lose its effectiveness and the emission control system to function improperly.
- EU area: Bioethanol fuel sold under names such as "E50" or "E85" and fuel containing a large amount of ethanol should not be used. The use of these fuels will damage the vehicle's fuel system. In case of any doubt, ask any authorized Lexus retailer or Lexus authorized repairer, or any reliable repairer.
- Except EU area: Bioethanol fuel sold under names such as "E50" or "E85" and fuel containing a large amount of ethanol should not be used. Your vehicle can use gasoline mixed with 10% max ethanol. The use of fuel with more than 10% ethanol content (E10) will damage the vehicle's fuel system. You must ensure that refueling is carried out only from a source where fuel specification and quality can be guaranteed. In case of any doubt, ask any authorized Lexus retailer or Lexus authorized repairer, or any reliable repairer.
- Do not use the methanol blended gasoline such as M15, M85, M100. The use of gasoline containing methanol may cause engine damage or failure.

Customizable features

Your vehicle includes a variety of electronic features that can be personalized to your preferences. These preferences can be changed by using the meter control switches, by using the Remote Touch, or at any authorized Lexus retailer or Lexus authorized repairer, or any reliable repairer.

Customizing vehicle features



■ Changing by using the Remote Touch



1 Press the "MENU" button on the Remote Touch.

2 Select  on the "Menu" screen and select "Vehicle".

Various setting can be changed. Refer to the list of settings that can be changed for details.

■ Changing by using the meter control switches

1 Press  or  of the meter control switches, select .

2 Press  or  of the meter control switches, select the item or the desired setting, and then press .

To go back to the previous screen, press .



Customizable features

Some function settings are changed simultaneously with other functions being customized. Contact any authorized Lexus retailer or Lexus authorized repairer, or any reliable repairer.

- ① Settings that can be changed using the Remote Touch
- ② Settings that can be changed using the meter control switches
- ③ Settings that can be changed by any authorized Lexus retailer or Lexus authorized repairer, or any reliable repairer

Definition of symbols: ○ = Available, – = Not available

■ **Meters and multi-information display (→P. 111)**

Function	Default setting	Customized setting	①	②	③
Speed warning	Off	On	–	○	–
Speed warning setting	30 km/h (20 mph)	30 to 260 km/h (20 to 160 mph)	–	○	–
Language*1	English	French	–	○	–
		German			
		Spanish			
		Italian			
		Russian			
Units*1	km (L/100 km)	km (km/L)	○	○	–
		miles (MPG)			
EV indicator	On	Off	–	○	–
 switch settings	Drive information 1	Desired status screen*2	–	○	–
Drive information screen displayed on the first screen of  (Drive information 1)	Current fuel consumption	*3	–	○	–
	Average fuel economy (after reset)				
Drive information screen displayed on the second screen of  (Drive information 2)	Distance (range)	*3	–	○	–
	Average speed (after reset)				

Function	Default setting	Customized setting	①	②	③
Drive information screen displayed on the third screen of  (Drive information 3)	Average fuel economy (after refuel)	*3	-	○	-
	Elapsed time (after start)				
Pop-up display	On	Off	-	○	-
Accent color *4	Color 1	Color 2	○	○	-
Changeover to tachometer when sport mode is selected	Auto	Hybrid system indicator (always)	-	○	-
		Tachometer (always)			
Clock	24-hour display	12-hour display	-	○	-
Needle *5	Blue	Red	-	○	-
		White			
Rev indicator *5	4000 r/min	2000 to 6000 r/min	-	○	-
		Off			
Rev peak *5	On	Off	-	○	-

*1: The default setting varies according to countries.



*2: Some status screens cannot be registered (indicated on the multi-information display)

*3: 2 of the following items: current fuel consumption, average fuel economy (after reset), average fuel economy (after refuel), average fuel economy (after start), average vehicle speed (after reset), average vehicle speed (after start), distance (driving range), distance (after start), elapsed time (after reset), elapsed time (after start), blank

*4: Except F SPORT models



*5: F SPORT models

■ LKA (Lane-Keeping Assist)* (→P. 282)

Function	Default setting	Customized setting	①	②	③
Lane centering function	Off	On	-	○	-
Steering assist	On	Off	-	○	-
Adjust alert type	 (Steering vibration)	 (Buzzer)	-	○	-
Alert sensitivity	Standard	High	-	○	-
Vehicle sway warning	On	Off	-	○	-
Vehicle sway warning sensitivity	Standard	Low	-	○	-
		High	-	○	-

*: If equipped

■ PCS (Pre-Crash Safety system)* (→P. 270)

Function	Default setting	Customized setting	①	②	③
PCS (Pre-Crash Safety system)	On	Off	-	○	-
Adjust alert timing	 (Middle)	 (Far)	-	○	-
		 (Near)	-	○	-

*: If equipped

■ **BSM (Blind Spot Monitor)*** (→P. 314)

Function	Default setting	Customized setting	①	②	③
BSM (Blind Spot Monitor)	On	Off	–	○	–

*: If equipped

■ **AFS (Adaptive Front-lighting System)*** (→P. 239)

Function	Default setting	Customized setting	①	②	③
AFS (Adaptive Front-lighting System)	On	Off	–	○	–

*: If equipped

■ **RSA (Road Sign Assist)*¹** (→P. 291)

Function	Default setting	Customized setting	①	②	③
RSA (Road Sign Assist)	On	Off	–	○	–
Excess speed notification method	Only visual	No Notification	–	○	–
		Visual and audible* ²	–	○	–
Excess speed notification level	3 km/h (1 mph)	5 km/h (3 mph)	–	○	–
		10 km/h (5 mph)	–	○	–
Other notifications method* ³	Only visual	No Notification	–	○	–
		Visual and audible* ²	–	○	–

*¹: If equipped

*²: If a speed limit with supplemental mark is exceeded, the warning buzzer does not operate.

*³: No-overtaking notification only

■ Door lock (→P. 139, 527)

Function	Default setting	Customized setting	①	②	③
Unlocking on second key turn (Allows all doors to be unlocked by turning the mechanical key twice in the driver's door)	Off (All doors unlocked in one step)	On (Driver's door unlocked in one step, all doors unlocked in two steps)	-	-	○
Speed linked door locking function	On	Off	○	-	○
Shift position linked door locking function	Off	On	○	-	○
Shift position linked door unlocking function	Off	On	○	-	○
Driver's door linked door unlocking function	On	Off	○	-	○
Locking/unlocking of the trunk when all doors are locked/unlocked	On	Off	-	-	○

■ Entry function* and wireless remote control (→P. 134, 153)

Function	Default setting	Customized setting	①	②	③
Operation signal (Emergency flashers)	On	Off	○	-	○
Time elapsed before automatic door lock function is activated if a door is not opened after being unlocked	30 seconds	60 seconds	-	-	○
		120 seconds	-	-	○
Open door reminder buzzer (When locking the vehicle)	On	Off	-	-	○

*: If equipped

■ Entry function* (→P. 153)

Function	Default setting	Customized setting	①	②	③
Smart entry & start system	On	Off	○	–	○
Unlocking operation	All the doors	Driver's door	○	–	○
Number of consecutive door lock operations	As many as desired	2 times	–	–	○

*: If equipped

■ Wireless remote control (→P. 134)

Function	Default setting	Customized setting	①	②	③
Wireless remote control	On	Off	–	–	○
Unlocking operation	Off (All doors unlocked in one step)	On (Driver's door unlocked in one step, all doors unlocked in two steps)	○	–	○
Trunk unlocking operation	Press and hold (short)	One short press	–	–	○
		Push twice			
		Press and hold (long)			
		Off			

■ Front seats (→P. 175)

Function	Default setting	Customized setting	①	②	③
Driver's seat movement when exiting the vehicle	Standard	Off	○	–	○
		Partial			
Selecting the door linking driving position memory with door unlock operation	Driver's door	All doors	–	–	○

■ Outside rear view mirrors (→P. 190)

Function	Default setting	Customized setting	①	②	③
Automatic mirror folding and extending operation	Linked to the locking/unlocking of the doors	Off			
		Linked to operation of the power switch	-	-	○
Linked mirror function when reversing	On	Off	-	-	○

■ Power windows and moon roof* (→P. 193, 196)

Function	Default setting	Customized setting	①	②	③
Mechanical key linked operation	Off	On	-	-	○
Wireless remote control linked operation	Off	On	-	-	○
Buzzer sounds if operated using wireless remote control	On	Off	-	-	○

*: If equipped

■ Automatic light control system (→P. 237)

Function	Default setting	Customized setting	①	②	③
Light sensor sensitivity	Standard	-2 to 2	○	-	○
Follow me home (Time elapsed before headlights automatically turn off)	30 seconds	60 seconds			
		90 seconds	-	-	○
		120 seconds			
Welcome light illumination control	On	Off	-	-	○

■ AHS (Adaptive High-beam System)*¹ (→P. 241)

Function	Default setting	Customized setting	①	②	③
Adaptive High-beam System	On	Off* ²	-	-	○
Clearance between a vehicle ahead and the shaded high beams	Standard	Narrow	-	-	○
		Wide	-	-	○
Vehicle speed at which the brightness and illuminated area adjustment of the high beams changes mode	Approximately 120 km/h (75 mph) or more	Approximately 100 km/h (63 mph) or more	-	-	○
		Approximately 80 km/h (50 mph) or more	-	-	○
Intensity adjustment of the high beams when driving around a curve (illuminates the area in the direction vehicle is turning more brightly)	On	Off	-	-	○
Projection distance adjustment of the low beams according to the distance to a preceding vehicle	On	Off	-	-	○

*¹: If equipped

*²: Only high beam will be turned on or off.

■ Lexus parking assist-sensor *1,2

Function	Default setting	Customized setting	①	②	③
Detection distance of the front center sensor	Far	Near	<input type="radio"/>	-	<input type="radio"/>
Detection distance of the rear center sensor	Far	Near	<input type="radio"/>	-	<input type="radio"/>
Buzzer volume	3	1 to 5	<input type="radio"/>	-	<input type="radio"/>
Display setting (when Lexus parking assist-sensor is operating)	All sensors displayed	Display off	<input type="radio"/>	-	<input type="radio"/>

*1: If equipped

*2: Refer to the "NAVIGATION AND MULTIMEDIA SYSTEM OWNER'S MANUAL".

■ Driving mode select switch (vehicles with Adaptive Variable Suspension system)(→P. 312)

Function	Default setting	Customized setting	①	②	③
Power train control	Normal	Power	<input type="radio"/>	-	-
		Eco			
Chassis control	Normal	Sport	<input type="radio"/>	-	-
Air conditioning operation	Normal	Eco	<input type="radio"/>	-	-

■ Automatic air conditioning system (→P. 346)

Function	Default setting	Customized setting	①	②	③
Switching between outside air and recirculated air mode linked to "AUTO" switch* operation	On	Off	○	–	○
A/C Auto switch operation	On	Off	○	–	○
Exhaust gas sensor sensitivity	Standard	-3 to 3	○	–	○

*: This is the switch for turning on and off the automatic mode of the air conditioning system, not the outside air or recirculated mode switch.

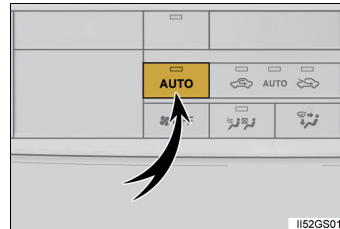

■ Front seat heaters (without seat ventilators)* (→P. 363)

Function	Default setting	Customized setting	①	②	③
Automatic operation of front seat heater	Off	On	–	–	○

*: If equipped

■ Front seat heaters and ventilators*1/rear seat heaters*2 (→P. 362)

Function	Default setting	Customized setting	①	②	③
Adjustment of the front seat heater temperature or the ventilator fan speed during automatic operation (individual seat adjustment available)	Level 3 (standard)	Level 1 (low) to level 5 (high)	○	–	○
Adjustment of the rear seat heater temperature during automatic operation (individual seat adjustment available)	Level 3 (standard)	Level 1 (low) to level 5 (high)	○	–	○
Rear seat heater start-up conditions when the power switch is in ON mode (individual seat adjustment available)	Off	On (AUTO)	○	–	○

*1: If both are equipped

*2: If equipped

■ Illumination (→P. 366)

Function	Default setting	Customized setting	①	②	③
Interior lights illumination control	On	Off	-	-	○
Time elapsed before the interior lights turn off	15 seconds	7.5 seconds	○	-	○
		30 seconds			
Operation after the power switch is turned off	On	Off	-	-	○
Operation when the doors are unlocked	On	Off	-	-	○
Operation when you approach the vehicle with the electronic key on your person (vehicles with entry function)	On	Off	-	-	○
Footwell lighting	On	Off	-	-	○
Outer foot lights	On	Off	-	-	○
Time elapsed before the outer foot lights turn off	15 seconds	Off			
		7.5 seconds	○	-	○
		30 seconds			
Enable/disable operation of the outer foot lights when you approach the vehicle with the electronic key on your person	On	Off	-	-	○
Enable/disable operation of the outer foot lights when the doors are unlocked with the power door lock switch	On	Off	-	-	○

■ Rear sunshade* (→P. 380)

Function	Default setting	Customized setting	①	②	③
Reverse operation	On	Off	–	–	○
Time elapsed before the reverse operation feature activates	0.7 seconds	0 second			
		0.9 seconds	–	–	○
		1.2 seconds			

*: If equipped

■ Vehicle customization

- When the speed linked door locking function and shift position linked door locking function are both on, the door lock operates as follows.
 - When shifting the shift lever to any position other than P, all the doors will be locked.
 - If the vehicle is started with all the doors locked, the speed linked door locking function would not operate.
 - If the vehicle is started with any door unlocked, the speed linked door locking function will operate.
- When the entry function is off, the selecting doors to unlock cannot be customized.
- When the doors remain closed after unlocking the doors and the automatic door lock function (time elapsed before the automatic door lock function is activated if a door is not opened after being unlocked) activates, the signals will be generated in accordance with the operation signal (buzzers) and the operation signal (emergency flashers) settings.
- Some settings can be changed using a switch or the Remote Touch screen. If a setting is changed using a switch, the changed setting will not be reflected on the Remote Touch screen until the power switch is turned off and then to ON mode.

■ When customizing using the Remote Touch

Stop the vehicle in a safe place, apply the parking brake, and shift the shift lever to P. Also, to prevent 12-volt battery discharge, leave the hybrid system operating while customizing the features.

⚠ WARNING

■ **During customization**
 As the hybrid system needs to be operating during customization, ensure that the vehicle is parked in a place with adequate ventilation. In a closed area such as a garage, exhaust gases including harmful carbon monoxide (CO) may collect and enter the vehicle. This may lead to death or a serious health hazard.

**NOTICE****■ During customization**

To prevent 12-volt battery discharge, ensure that the hybrid system is operating while customizing features.

Item to initialize

The following item must be initialized for normal system operation after such cases as the 12-volt battery being reconnected, or maintenance being performed on the vehicle:

Item	When to initialize	Reference
Oil maintenance	<ul style="list-style-type: none"> • After the maintenance is performed 	P. 408
Tire pressure warning system *	<ul style="list-style-type: none"> • When rotating the tires • When changing the tire inflation pressure by changing traveling speed or load weight, etc. 	P. 418

*: If equipped

Index

What to do if..
(Troubleshooting).....578
Alphabetical index.....582

For information regarding the equipment listed below, refer to the
“NAVIGATION AND MULTIMEDIA SYSTEM OWNER’S MAN-
UAL”

- Audio system
- Navigation system
- Lexus parking assist-sensor
- Lexus parking assist monitor

What to do if... (Troubleshooting)

If you have a problem, check the following before contacting any authorized Lexus retailer or Lexus authorized repairer, or any reliable repairer.

The doors cannot be locked, unlocked, opened or closed



You lose your keys

- If you lose your mechanical keys, new genuine mechanical keys can be made by any authorized Lexus retailer or Lexus authorized repairer, or any reliable repairer. (→P. 136)
- If you lose your electronic keys, the risk of vehicle theft increases significantly. Contact any authorized Lexus retailer or Lexus authorized repairer, or any reliable repairer immediately. (→P. 137)



The doors cannot be locked or unlocked

- Is the electronic key battery weak or depleted? (→P. 435)
- Vehicles with entry function
Is the power switch in ON mode?
When locking the doors, turn the power switch off. (→P. 218)
- Vehicles with entry function
Is the electronic key left inside the vehicle?
When locking the doors, make sure that you have the electronic key on your person.
- The function may not operate properly due to the condition of the radio wave. (→P. 155)



The rear door cannot be opened

- Is the child-protector lock set?
The rear door cannot be opened from inside the vehicle when the lock is set. Open the rear door from outside and then unlock the child-protector lock. (→P. 143)

**The trunk lid is closed with the electronic key left inside**

- The function to prevent the electronic key from being left inside the trunk will operate and you can open the trunk as usual. Take the key out from the trunk. (→P. 148)

If you think something is wrong**The hybrid system does not start**

- Did you press the power switch while firmly depressing the brake pedal? (→P. 217)
- Is the shift lever in P? (→P. 219)
- Is the electronic key anywhere detectable inside the vehicle? (→P. 153)
- Is the steering wheel unlocked? (→P. 219)
- Is the electronic key battery weak or depleted?
In this case, the hybrid system can be started in a temporary way. (→P. 528)
- Is the 12-volt battery discharged? (→P. 530)

**The shift lever cannot be shifted from P even if you depress the brake pedal**

- Is the power switch in ON mode?
If you cannot release the shift lever by depressing the brake pedal with the power switch in ON mode (→P. 229)

**The steering wheel cannot be turned after the hybrid system is stopped**

- It is locked automatically to prevent theft of the vehicle. (→P. 219)



The windows do not open or close by operating the power window switches

- Is the window lock switch pressed?
The power window except for the one at the driver's seat cannot be operated if the window lock switch is pressed. (→P. 193)



The power switch is turned off automatically

- The auto power off function will be operated if the vehicle is left in ACCESSORY or ON mode (the hybrid system is not operating) for a period of time. (→P. 219)



A warning buzzer sounds during driving

- The seat belt reminder light is flashing
Are the driver and the front passenger wearing the seat belts? (→P. 462)
 - The parking brake indicator is on
Is the parking brake released? (→P. 232)
- Depending on the situation, other types of warning buzzer may also sound. (→P. 460, 466)



An alarm is activated and the horn sounds (if equipped)

- Did anyone inside the vehicle open a door or anything move inside the vehicle during setting the alarm?
The sensor detects them and the alarm sounds. (→P. 91)
- To stop the alarm, turn the power switch to ON mode or start the hybrid system.



A warning buzzer sounds when leaving the vehicle (vehicles with entry function)

- Is the electronic key left inside the vehicle or the moon roof opened (if equipped)?
Check the message on the multi-information display. (→P. 466)

**A warning light turns on or a warning message is displayed**

- When a warning light turns on or a warning message is displayed, refer to P. 460, 466.

When a problem has occurred**If you have a flat tire**

- Vehicles with spare tire
Stop the vehicle in a safe place and replace the flat tire with the spare tire. (→P. 498)
- Vehicles without spare tire
Stop the vehicle in a safe place and repair the flat tire temporarily with the emergency tire puncture repair kit. (→P. 509)

**The vehicle becomes stuck**

- Try the procedure for when the vehicle becomes stuck in mud, dirt, or snow. (→P. 542)

Alphabetical index

A

A/C	346
Air conditioning filter	433
Changing the rear seat settings.....	353
Front automatic air conditioning system.....	346
nanoe™ system	356
Pollen removal mode	352
Rear air conditioning system	358
S-FLOW mode.....	347
ABS (Anti-lock Brake System).....	324
Function.....	324
Warning light.....	461
Warning message.....	466
Adaptive Front-lighting System (AFS)	239
Adaptive Variable Suspension system (AVS).....	325
AFS (Adaptive Front-lighting System).....	239
AHS (Adaptive High-beam System).....	241
Air conditioning filter	433
Air conditioning system	346
Air conditioning filter.....	433
Changing the rear seat settings.....	353
Front automatic air conditioning system.....	346
nanoe™ system	356
Pollen removal mode	352
Rear air conditioning system	358
S-FLOW mode.....	347

Airbags.....	43
Airbag manual on-off system.....	54
Airbag operating conditions	49
Airbag precautions for your child	45
Airbag warning light.....	460
Correct driving posture.....	36
Curtain shield airbag operating conditions	49
Curtain shield airbag precautions	47
General airbag precautions.....	45
Locations of airbags	43
Modification and disposal of airbags.....	48
Side airbag operating conditions	49
Side airbag precautions.....	45
Side and curtain shield airbags operating conditions.....	49
Side and curtain shield airbags precautions	45
SRS airbags.....	43
Airbag manual on-off system	54
Alarm.....	91
Alarm.....	91
Warning buzzer.....	460, 466
Anchor brackets.....	66
Antennas (smart entry & start system)	153
Anti-lock Brake System (ABS).....	324
Function.....	324
Warning light.....	461
Warning message	466

Approach warning
 Dynamic radar cruise control
 with full-speed range.....302
 Armrest.....380
 Ashtrays.....378
 Assist grips 383
 Audio input*
 Audio system*
 Automatic headlight leveling
 system240
 Automatic High Beam 246
 Automatic light control system 237
 AUX port*
 Auxiliary boxes373
 AVS (Adaptive Variable
 Suspension system).....325

B

Back-up light
 Replacing light bulb.....443
 Wattage.....558
 Battery (12-volt battery)..... 412
 If the 12-volt battery is
 discharged.....530
 Preparing and checking
 before winter334
 Warning light.....460
 Battery (traction battery)..... 80

Blind Spot Monitor (BSM)314
 Blind Spot Monitor function.....319
 Rear Crossing Traffic
 Alert function.....321
 Bluetooth®*
 Brake
 Brake Hold.....235
 Fluid.....554
 Parking brake.....232
 Regenerative braking.....78
 Warning light.....460, 462
 Warning message466
 Brake assist324
 Brake Hold.....235
 Break-in tips202
 Brightness control
 Instrument panel light control.....107
 BSM (Blind Spot Monitor)314
 Blind Spot Monitor function.....319
 Rear Crossing Traffic
 Alert function.....321

C

Card key134
 Care 390, 394
 Aluminum wheels.....391
 Exterior390
 Interior394
 Seat belts395

*: Refer to the "NAVIGATION AND MULTIMEDIA SYSTEM OWNER'S MANUAL".

Cargo hooks.....	374	Cleaning.....	390, 394
CD player*		Aluminum wheels.....	391
Chains.....	336	Exterior.....	390
Child restraint system.....	57	Interior.....	394
Baby seats, definition.....	58	Seat belts.....	395
Baby seats, installation.....	67	Clock.....	105, 378
Child seats, definition.....	58	Coat hooks.....	382
Child seats, installation.....	67	Condenser.....	411
Installing CRS with ISOFIX		Console box.....	370
rigid anchors.....	70	Console box light.....	371
Installing CRS with seat belts.....	67	Coolant.....	409
Installing CRS with top strap.....	71	Capacity.....	552
Junior seats, definition.....	58	Checking.....	409
Junior seats, installation.....	69	Preparing and checking	
Child safety.....	56	before winter.....	334
12-volt battery		Cooling system.....	409
precautions.....	414, 534	Engine overheating.....	535
Airbag precautions.....	45	Hybrid system overheating.....	535
Child restraint system.....	57	Consumption screen.....	126
How your child should		Cruise control	
wear the seat belt.....	39, 40	Cruise control.....	308
Installing child restraints.....	66	Dynamic radar cruise control	
Moon roof precautions.....	198	with full-speed range.....	296
Power window lock switch.....	193	Cup holders.....	371
Power window precautions.....	195	Curtain shield airbags.....	43
Rear door child-protectors.....	143	Customizable features.....	561
Removed electronic key			
battery precautions.....	436		
Seat belt comfort guide.....	39		
Seat belt precautions.....	42		
Seat heater precautions.....	361		
Trunk precautions.....	149		
Child-protectors.....	143		

D

DAB (Digital Audio Broadcast)*
 Daytime running light system240
 Defogger
 Front windshield.....352
 Outside rear view mirrors.....352
 Rear window.....352
 Differential.....554
 Digital Audio Broadcast (DAB)*
 Dimensions.....546
 Display
 12.3-inch display344
 Drive information.....113
 Dynamic radar cruise control
 with full-speed range.....296
 Energy monitor.....126
 LKA (Lane-Keeping Assist).....286
 Multi-information display111
 Trip information104
 Warning message.....466
 Do-it-yourself maintenance399
 Door courtesy lights
 Location.....366
 Wattage.....558
 Door lock
 Doors.....139
 Smart entry & start system.....153
 Wireless remote control.....134

Doors.....139
 Automatic door locking and
 unlocking system143
 Door glasses.....193
 Door lock142
 Open door warning buzzer154
 Outside rear view mirrors190
 Rear door child-protector143
 Double locking system.....90
 Drive info 1/Drive info 2/
 Drive info 3.....113
 Drive information116
 Drive-Start Control.....201, 228
 Driver's seat position memory178
 Driving position memory179
 Memory recall function.....181
 Power easy access system.....178
 Driving200
 Break-in tips.....202
 Correct driving posture.....36
 Driving mode select switch.....311
 Hybrid vehicle driving tips.....331
 Procedures.....200
 Winter drive tips334
 DRS (Dynamic Rear Steering)325
 Function.....325
 Warning message466

*: Refer to the "NAVIGATION AND MULTIMEDIA SYSTEM OWNER'S MANUAL".

Dynamic radar cruise control
with full-speed range296
 Function296
 Warning message.....466
Dynamic Rear Steering (DRS).....325
 Function325
 Warning message.....466
DVD player *

E

Eco drive mode311
Electric motor (traction motor) 76
Electric Power Steering (EPS).....325
 Function325
 Warning light.....461
 Warning message.....466
Electronic key..... 134
 Battery-saving function..... 155
 If the electronic key does not
 operate properly 527
 Replacing the battery.....435
Emergency, in case of
 If a warning buzzer sounds 460
 If a warning light turns on..... 460
 If a warning message is
 displayed466
 If the 12-volt battery is
 discharged..... 530
 If the electronic key does not
 operate properly 527
 If the hybrid system will not
 start..... 523
 If the parking brake cannot
 be released.....525
 If you have a flat tire498, 509

 If you think something
 is wrong 459
 If your vehicle becomes
 stuck 542
 If your vehicle has to be
 stopped in an emergency 453
 If your vehicle needs to
 be towed 454
 If your vehicle overheats..... 535
Emergency brake signal..... 325
Emergency flashers..... 452
Emergency tire puncture
 repair kit509
Energy monitor126
Engine 548
 Accessory mode218
 Compartment 403
 Engine switch 217
 Hood401
 How to start the hybrid
 system..... 217
 Identification number..... 548
 Ignition switch
 (power switch)..... 217
 Overheating535
 Power switch 217
Engine compartment cover 405
Engine coolant.....409
 Capacity..... 552
 Checking.....409
 Preparing and checking
 before winter..... 334

Engine coolant temperature
 gauge.....105
 Engine oil.....406
 Capacity.....550
 Checking.....406
 Oil level warning message.....466
 Oil pressure warning
 message.....466
 Preparing and checking
 before winter.....334
 Engine switch.....217
 Auto power off function.....219
 Changing the power switch
 modes.....218
 If your vehicle has to be
 stopped in an emergency.....453
 Starting the hybrid system.....217
 EPS (Electric Power Steering).....325
 Function.....325
 Warning light.....461
 Warning message.....466
 EV drive mode.....222

F

First-aid kit storage net.....375
 Flat tire
 Vehicles with spare tire.....498
 Vehicles without spare tire.....509
 Floor mats.....34
 Fluid
 Brake.....554
 Hybrid transmission.....553
 Washer.....411

Fog lights.....250
 Replacing light bulbs.....449
 Switch.....250
 Follow me home system.....238
 Footwell light.....366
 Front air conditioning system.....346
 Front fog lights.....250
 Replacing light bulbs.....449
 Switch.....250
 Wattage.....449
 Front personal lights.....367
 Front position lights.....237
 Light switch.....237
 Replacing light bulbs.....449
 Welcome light illumination
 control.....140
 Front seats.....175
 Adjustment.....175
 Cleaning.....394
 Correct driving posture.....36
 Driving position memory.....178
 Head restraints.....183
 Power easy access system.....178
 Seat heaters.....362
 Seat position memory.....178
 Seat ventilators.....362
 Front turn signal lights.....231
 Replacing light bulbs.....443, 449
 Turn signal lever.....231
 Wattage.....558

*: Refer to the "NAVIGATION AND MULTIMEDIA SYSTEM OWNER'S MANUAL".

Fuel	257
Capacity	549
Fuel gauge.....	105
Information.....	559
Refueling	257
Type.....	549
Warning light.....	462
Warning messages.....	466
Fuel consumption	
Average fuel consumption	113
Average fuel consumption	
after refueling	113
Current fuel consumption.....	113
Fuel filler door	257
Refueling	257
When the fuel filler door	
cannot be opened	259
Fuses	437

G

Gauges	104
Glove box.....	370
Glove box light	370
Grille Shutter system	
Warning message.....	466

H

Hands-free system	
(for cellular phone)*	
Head restraints.....	183
Headlight cleaner.....	252, 254
Headlights	237
Adaptive Front-lighting	
System (AFS).....	239
AHS (Adaptive High-beam	
System).....	241
Automatic High Beam	
system.....	246
Follow me home system.....	238
Headlight leveling warning	
message	466
Light switch.....	237
Replacing light bulbs	449
Head-up display.....	119
Heated steering wheel.....	361
Heaters	346
Air conditioning system	346
Heated steering wheel	362
Outside rear view mirrors	352
Seat heaters.....	362
High-voltage components	80
Hood.....	401
Open	401
Warning message	466

Hooks

- Cargo hooks..... 374
- Coat hooks.....382
- Luggage hook.....374
- Retaining hooks (floor mat)..... 34

Horn186

Hybrid battery (traction battery)

- Location.....80
- Specification.....549

Hybrid battery (traction battery) air vents.....81

Hybrid system76

- Emergency shut off system.....81
- Energy monitor/ consumption screen.....126
- EV drive mode222
- High voltage components80
- Hybrid System Indicator108
- Hybrid system precautions.....80
- Hybrid vehicle driving tips331
- If the hybrid system will not start523
- Overheating.....535
- Power (ignition) switch.....217
- Regenerative braking.....78
- Starting the hybrid system.....217

Hybrid System Indicator108

Hybrid transmission.....224

- If the shift lever cannot be shifted from P.....229
- Paddle shift switches.....226
- S mode.....227

I

Identification..... 547

- Engine.....548
- Vehicle.....547

Ignition switch (power switch)217

- Auto power off function.....219
- Changing the power switch modes.....218
- If your vehicle has to be stopped in an emergency453
- Starting the hybrid system217

Illuminated entry system.....368

Immobilizer system.....85

Indicators101

Initialization

- Items to initialize.....576
- Moon roof.....197
- Power windows194
- Tire pressure warning system.....418

Initiators (tire pressure warning system).....427

Inside door handle lights366

Inside rear view mirror.....188

Instrument panel light control107

Interior lights.....366

Intrusion sensor and tilt sensor94

ISOFIX rigid anchors66

*: Refer to the "NAVIGATION AND MULTIMEDIA SYSTEM OWNER'S MANUAL".

J

Jack
 Positioning the jack402
 Vehicle-equipped jack 499, 511
 Jack handle 499, 511
 Jam protection function
 Moon roof197
 Power trunk lid.....149
 Power window.....193

K

Keyless entry 153
 Smart entry & start system 153
 Wireless remote control134
 Keys 134
 Battery-saving function.....155
 Electronic key134
 Engine switch.....217
 If the electronic key does not
 operate properly 527
 If you lose your keys 136, 137
 Key number plate134
 Keyless entry 134, 153
 Mechanical key..... 135
 Power switch217
 Replacing the battery.....435
 Warning buzzer154
 Wireless remote control key134
 Knee airbags..... 43

L

Language (multi-information
 display) 562
 LDH (Lexus Dynamic Handling
 system)..... 325
 Lever
 Auxiliary catch lever.....401
 Hood lock release lever401
 Shift lever224
 Turn signal lever231
 Wiper lever251
 Lexus Dynamic Handling system
 (LDH)..... 325
 Lexus parking assist monitor*
 Lexus parking assist-sensor*
 Function*
 Warning message466
 Lexus Safety System+261
 AHS (Adaptive High-beam
 System) 241
 Automatic High Beam 246
 Dynamic radar cruise control
 with full-speed range 296
 LKA (Lane-Keeping Assist) 282
 PCS (Pre-Crash Safety
 system)..... 270
 RSA (Road Sign Assist)..... 291
 License plate lights 237
 Light switch.....237
 Replacing light bulbs 449
 Welcome light illumination
 control140

Light bulbs
 Replacing.....443
 Wattage.....558

Lights
 AHS (Adaptive High-beam System).....241
 Automatic High Beam system.....246
 Fog light switch.....250
 Follow me home system.....238
 Headlight switch.....237
 Illuminated entry system.....368
 Interior light.....367
 Interior lights list.....366
 Personal lights.....367
 Replacing light bulbs.....443
 Trunk light.....148
 Turn signal lever.....231
 Vanity lights.....377
 Wattage.....558
 Welcome light illumination control.....140

LKA (Lane-Keeping Assist).....282
 Operation.....286
 Warning messages.....466

Lock steering column.....219

Low profile tire.....420

Luggage hook.....374

Luggage security system.....148

M

Main display.....344

Maintenance
 Do-it-yourself maintenance.....399
 Maintenance data.....546
 Maintenance requirements.....397

Malfunction indicator lamp.....460

Master warning light.....462

Meter.....104
 Head-up display.....119
 Indicators.....101
 Instrument panel light control.....107
 Meters.....104
 Multi-information display.....111
 Warning lights.....99

Mirrors
 Inside rear view mirror.....188
 Outside rear view mirror defoggers.....352
 Outside rear view mirrors.....190
 Vanity mirrors.....377

Moon roof.....196
 Door lock linked moon roof operation.....197
 Jam protection function.....197
 Operation.....196
 Warning message.....466

MP3 disc*

*: Refer to the "NAVIGATION AND MULTIMEDIA SYSTEM OWNER'S MANUAL".

Multi-information display 111
 Audio system-linked 111
 Drive information 113
 Dynamic radar cruise control
 with full-speed range 296
 G-force 114
 LKA (Lane-Keeping Assist) 282
 Navigation system-linked 111
 Settings 115
 Switch settings 115
 Switching the display 112

N

nanoe™ system 356
 Navigation system*

O

Odometer 105
 Oil
 Differential oil 554
 Engine oil 550
 Opener
 Fuel filler door 257
 Hood 401
 Trunk 146
 Outer foot lights
 Location 366
 Replacing light bulbs 445
 Wattage 558

Outside rear view mirrors 190
 Adjusting and folding 190
 BSM (Blind Spot Monitor) 314
 Linked mirror function
 when reversing 191
 Mirror position memory 178
 Outside rear view mirror
 defoggers 352
 Outside temperature display 105
 Overheating 535

P

Paddle shift switches 226
 Parking assist sensors*
 Parking brake 232
 If the parking brake cannot
 be released 525
 Operation 232
 Parking brake engaged
 warning buzzer 466
 Parking brake engaged
 warning message 466
 PCS
 (Pre-Crash Safety system) 270
 Function 270
 Warning light 461
 Warning message 466
 Personal lights 367
 Pollen removal mode 352
 Power control unit 80

Power control unit coolant409
 Capacity552
 Checking409
 Preparing and checking
 before winter334
 Power easy access system178
 Power outlets379
 Power steering.....325
 Warning light461
 Warning message.....466
 Power switch217
 Auto power off function219
 Changing the power switch
 modes218
 If your vehicle has to be
 stopped in an emergency.....453
 Starting the hybrid system.....217
 Power trunk lid.....146
 Power windows193
 Door lock linked window
 operation194
 Jam protection function.....193
 Operation.....193
 Window lock switch.....193
 Pre-Crash Safety system
 (PCS).....270
 Function270
 Warning light461
 Warning message.....466

R

Radar cruise control (dynamic
 radar cruise control with
 full-speed range)296
 Radiator411
 Radio*
 Radio Data System (RDS)*
 Rear air conditioning system358
 Rear door sunshades380
 Rear fog light250
 Replacing light bulb449
 Switch250
 Rear personal lights.....367
 Rear seat heaters.....362
 Rear sunshade380
 Operation380
 Reverse operation feature381
 Rear turn signal lights231
 Replacing light bulbs449
 Turn signal lever.....231
 Rear view mirror
 Inside rear view mirror*
 Outside rear view mirrors190
 Rear view monitor system*
 Rear window defogger352

*: Refer to the "NAVIGATION AND MULTIMEDIA SYSTEM OWNER'S MANUAL".

Refueling 257
 Capacity 549
 Fuel types 549
 Opening the fuel tank cap 259
 When the fuel filler door
 cannot be opened 259
 Regenerative braking 78
 Remote Touch*
 Replacing
 Electronic key battery 435
 Fuses 437
 Light bulbs 442
 Tires 498
 Rev indicator 106
 Rev peak 106
 Road accident cautions 83

S

Seat belt reminder light 462
 Seat belts 38
 Adjusting the seat belt 39
 Child restraint system
 installation 67
 Cleaning and maintaining
 the seat belt 395
 Emergency Locking
 Retractor (ELR) 40
 How to wear your seat belt 38
 How your child should wear
 the seat belt 40
 Pregnant women, proper
 seat belt use 41
 Reminder light and buzzer 462
 Seat belt pretensioners 39
 SRS warning light 460

Seat heaters 362
 Seat position memory 178
 Seat ventilators 362
 Seats 175
 Adjustment 175
 Adjustment precautions 176
 Child seats/child restraint
 system installation 66
 Cleaning 394
 Driving position memory 178
 Head restraints 183
 Power easy access system 178
 Properly sitting in the seat 36
 Seat heaters 362
 Seat position memory 178
 Seat ventilators 362
 Sensor
 Automatic headlight system 240
 Automatic High Beam
 system 246
 Inside rear view mirror 189
 Intrusion sensor and tilt sensor 94
 Lexus parking assist-sensor*
 LKA (Lane-Keeping Assist) 282
 Radar sensor 263, 318
 Rain-sensing windshield
 wipers 255
 Service plug 80
 Service reminder indicators 98
 S-FLOW mode 347

Shift lever.....	224	Specifications.....	546
Hybrid transmission.....	224	Speech command system*	
If the shift lever cannot be		Speedometer.....	104
shifted from P.....	229	Sport mode.....	311
Shift lever light.....	366	Steering lock.....	219
Shift lock system.....	228	Column lock release.....	220
Side airbags.....	43	Steering lock system warning	
Side display.....	344	message.....	496
Side mirrors.....	190	Steering wheel.....	186
Adjusting and folding.....	190	Adjustment.....	186
BSM (Blind spot monitor).....	314	Audio switches*	
Linked mirror function when		Heated steering wheel.....	362
reversing.....	191	Power easy access system.....	178
Mirror position memory.....	178	Steering wheel position	
Side turn signal lights.....	231	memory.....	178
Replacing light bulbs.....	449	Stop lights	
Turn signal lever.....	231	Emergency brake signal.....	325
Smart entry & start system.....	153	Replacing light bulbs.....	449
Antenna location.....	153	Storage feature.....	369
Entry functions.....	139, 146	Storage precautions.....	369
Starting the hybrid system.....	217	Stuck	
Warning message.....	466	If the vehicle becomes stuck.....	542
Snow mode.....	225	Sun visors.....	377
Snow tires.....	338	Sun shade	
Spare tire.....	498	Rear.....	380
Inflation pressure.....	557	Rear door.....	381
Storage location.....	499	Roof.....	197
Spark plug.....	552		

*: Refer to the "NAVIGATION AND MULTIMEDIA SYSTEM OWNER'S MANUAL".

Switches

Adaptive High-beam System
 switch.....241

Audio remote control switches*

Automatic High Beam
 switch.....246

Brake hold switch.....235

Cruise control
 switch.....296, 308

Door lock switches.....142

Driving mode select switch.....311

Driving position memory
 switches.....178

Emergency flashers switch.....452

EV drive mode switch.....222

Fog light switch.....250

Heated steering wheel
 switch.....362

HUD (Head-up display)
 switches.....119

Ignition switch.....217

Lexus parking assist-sensor
 switch*

Light switch.....237

LKA (Lane-Keeping Assist)
 switch.....286

Meter control switches.....112

Moon roof switches.....196

Outside rear view mirror
 switches.....190

Paddle shift switches.....226

Parking brake switches.....232

Power door lock switch.....142

Power switch.....217

Power window switches.....193

Rear sunshade switch.....380

Rear window and outside rear
 view mirror defoggers
 switch.....352

Seat heater switches.....362

Seat ventilator switches.....362

Snow mode switch.....225

Talk switch*

Telephone switches*

Tilt and telescopic steering
 control switch.....186

Trunk closer switch.....147

Trunk opener switch.....146

Trunk opener main switch.....148

Vehicle-to-vehicle
 distance button.....302

VSC OFF switch.....326

Window lock switch.....193

Windshield wipers
 and washer switch.....251

T

Tachometer 104

Tail lights..... 237
 Light switch.....237
 Replacing light bulbs.....449
 Welcome light illumination
 control.....140

Talk switch*

Telephone switches*

Theft deterrent system
 Alarm.....91
 Double locking system.....90
 Immobilizer system.....85
 Intrusion sensor and tilt
 sensor.....94

Tire inflation pressure	429	Tools.....	499, 511
Maintenance data.....	555	Top strap	71
Tire inflation pressure		Towing	454
display function.....	417	Emergency towing	454
Warning light.....	463	Towing capacity.....	546
Warning message.....	466	Towing eyelet.....	456
Tire pressure warning system	417	Trailer towing	209, 210
Function.....	417	Traction battery (hybrid battery)	80
Initializing.....	418	Traction Control (TRC).....	324
Installing tire pressure warning		Traction motor (electric motor).....	76
valves and transmitters.....	418	Trailer towing	209, 210
Registering ID codes	419	Transmission.....	224
Warning light.....	463	Driving mode select switch.....	311
Warning message.....	466	Hybrid transmission.....	224
Tires	416	If the shift lever cannot be	
Chains	336	shifted from P.....	229
Checking.....	416	Paddle shift switches.....	226
Emergency tire puncture		S mode	227
repair kit.....	509	TRC (Traction Control).....	324
If you have a flat tire.....	498, 509	Function.....	324
Inflation pressure.....	555	TRC OFF switch	326
Replacing.....	498	Trip information.....	104
Rotating tires	417	Trip meters	104
Size.....	555		
Snow tires	338		
Spare tire.....	498		
Tire inflation pressure display			
function.....	417		
Tire pressure warning system.....	417		
Warning light.....	463		
Warning message.....	466		

*: Refer to the "NAVIGATION AND MULTIMEDIA SYSTEM OWNER'S MANUAL".

Trunk.....	146
Jam protection function.....	151
Luggage security system.....	148
Open trunk warning message.....	466
Power trunk lid.....	146
Smart entry & start system.....	146
Trunk closer switch.....	147
Trunk easy closer.....	148
Trunk features.....	374
Trunk grip.....	147
Trunk light.....	148
Trunk opener main switch.....	148
Trunk opener switch.....	146
Wireless remote control.....	134
Trunk light.....	148
Trunk light.....	148
Wattage.....	558
Turn signal lights.....	231
Replacing light bulbs.....	443, 449
Turn signal lever.....	231
Wattage.....	558

U

USB port*	
-----------	--

V

Vanity lights.....	377
Vanity lights.....	377
Wattage.....	558
Vanity mirrors.....	377
Vanity lights.....	377

Variable Gear Ratio Steering (VGRS).....	324
Function.....	324
Warning message.....	466
VDIM (Vehicle Dynamics Integrated Management).....	325
Vehicle identification number.....	547
Vehicle Stability Control (VSC).....	324
Ventilators (seat ventilators).....	362
VGRS (Variable Gear Ratio Steering).....	324
Function.....	324
Warning message.....	466
VSC (Vehicle Stability Control).....	324

W

Warning buzzers	
Approach warning.....	303
Brake system.....	460
Downshifting.....	228
Key reminder.....	495
Lexus parking assist-sensor*	
Open door.....	468
Open hood.....	468
Open moon roof.....	481
Open trunk.....	468
Open window.....	481
Seat belt reminder.....	462
Warning label.....	80

Warning lights.....	99	Washing and waxing.....	390
ABS.....	461	Weight	546
AFS OFF indicator.....	462	Welcome light illumination	
Brake hold operated		control.....	140
indicator.....	462	Wheels.....	431
Brake system	460,462	Replacing.....	431
Charging system	460	Size.....	555
Electric power steering		Window glasses.....	193
system.....	461	Window lock switch.....	193
Low fuel level.....	462	Windows.....	193
Malfunction indicator lamp.....	460	Power windows	193
Master warning light	462	Rear window defogger	352
Parking brake indicator	462	Washer.....	251
Pre-Crash Safety system.....	461	Windshield wiper de-icer	352
Seat belt reminder light.....	462	Windshield wipers	251
Slip indicator.....	461	Intermittent windshield wipers	
SRS.....	460	with interval adjuster	251
Tire pressure.....	463	Position.....	337
Warning messages.....	466	Rain-sensing windshield	
Warning reflector storage belt.....	376	wipers	253
Washer.....	251	Winter driving tips	334
Checking.....	411	Wireless remote control key.....	134
Low washer fluid warning		Battery-saving function	155
message.....	466	Locking/Unlocking.....	134
Preparing and checking		Replacing the battery	435
before winter.....	334	WMA disc*	
Switch.....	251		

*: Refer to the "NAVIGATION AND MULTIMEDIA SYSTEM OWNER'S MANUAL".

GAS STATION INFORMATION		
Auxiliary catch lever P. 401	Trunk opener P. 146	Fuel filler door P. 259
Hood lock release lever P. 401	Tire inflation pressure P. 555	
Fuel tank capacity (Reference)	66 L (17.4 gal., 14.5 Imp.gal.)	
Fuel type	EU area: Unleaded gasoline conforming to European standard EN228 only Except EU area: Unleaded gasoline only P. 549	
Cold tire inflation pressure	P. 555	
Engine oil capacity (Drain and refill – reference)	P. 550	
Engine oil type	“Toyota Genuine Motor Oil” or equivalent Oil grade: 0W-20, 5W-30 and 10W-30: API grade SL “Energy-Conserving”, SM “Energy-Conserving” or SN “Resource-Conserving”; or ILSAC multi-grade engine oil 15W-40: API grade SL, SM or SN multigrade engine oil P. 550	